

TEX

design Raw Edges



MU
TIN
A

“Se ci guardiamo intorno, ci accorgiamo che quasi ogni oggetto ha una particolare finitura, sia esso un materiale naturale, sia esso handmade. Più che creare noi ex novo altre texture, abbiamo ricercato l’effetto impronta e costruito un nostro book tattile di riferimento ricavando calchi in plastilina delle superfici di oggetti e materiali per noi interessanti”.

“Looking around us, almost every object has its own particular texture, whether it is a natural or a handmade material. Rather than designing new textures by ourselves, we have reached a print effect and created our reference tactile library by placing plasticine on objects and materials we thought were interesting”.

Yael Mer - Shay Alkalay



LA COLLEZIONE

L'idea di una collezione ceramica ricca e multicolore ispirata alle texture tessili è stato il punto di partenza del progetto sviluppato dallo studio Raw Edges di Londra per Mutina. "Riuscire a creare una texture tangibile è la vera sfida quando si disegnano piastrelle in ceramica", affermano i due giovani designer. "A sorpresa sono state proprio le texture tessili a condurci alla definizione della nuova collezione Tex. La forma della piastrella è un ingrandimento semplificato della lavorazione a maglia di base: osservando attentamente un tessuto lavorato a maglia, si può vedere una ripetizione di cuciture, allineate in file simmetriche una di fianco all'altra. I rombi possono essere disposti in tre pattern principali, ognuno dei quali ha un impatto differente. La collezione ha 8 differenti colori, ciascuno declinato in tre tonalità, un mix ispirato proprio al design tessile, dove un solo tipo di tessuto può essere costituito dalle diverse sfumature di un filato. Per amplificare l'effetto sorpresa e stimolare la creatività e personalizzazione, le tre tonalità saranno inserite in modo casuale nel packaging di Tex così che, durante la posa delle piastrelle, si potranno ottenere composizioni inaspettate. Allo stesso modo, sono previsti i Runner, installazioni su rete con pattern predefiniti, simili a mosaici. I Runner permetteranno di collocare gli elementi grafici in posizioni particolari sia a rivestimento che a pavimento (ad esempio a cornice, come elemento centrale o pattern lineare). La produzione di Tex è artigianale e consente a noi e a Mutina la varietà delle texture, l'autenticità dei colori e le qualità tattili dello smalto. Inoltre la verniciatura colorata e naturale applicata alla ceramica bianca crea una lucentezza irregolare in alcuni luoghi e più satura in altri".

THE COLLECTION

A rich multi-colored ceramic tile collection inspired by textiles textures was the starting point of the new project designed for Mutina by Raw Edges studio in London. "Creating a tangible texture is one of the challenges when designing ceramics tiles", the two young designers state. "Looking around us, almost every object has its own particular texture, whether it's a natural or a handmade material. Rather than designing new textures by ourselves, we have reached a print effect and created our reference tactile library by placing plasticine on objects and materials we thought were interesting. To our surprise, it were the textures taken from textiles which have led us to define the new collection Tex. The shape of the tile is a simplified enlargement of the basic knitted stitch: when looking carefully into a knitted textile, a repetition of stitches can be seen aligned in symmetric rows next to each other. This rhombus can be arranged in three main fashions, each of which has a different impact. The collection has eight different colors, each of which contains a group of three shades. This triple shade mixture was inspired as well by textile design, re-creating the feel of the different tones of the yarn. To enhance the surprise effect and to increase the creativity and personalization, the three shades will be placed randomly in the packages; by this, when installing Tex, arbitrary arrangements could be achieved. On the other hand, in addition to the single tiles installation, premade patterns named Runner, will be arranged on a mesh similarly to mosaics settings. These meshes will allow locating graphic elements in particular places on the wall or on the floor (for instance, as a frame to the room, a central element or a linear pattern). The production of Tex is artisanal and enables a large multiplicity of textures, the verity of colors and the tactile qualities of the glaze. In addition, the colorful and natural glaze applied on a white ceramics creates an irregular effect in certain places, while a more saturated one in others".



unico formato 11,5x20 cm - only size 11,5x20 cm



texture tattili - tactile textures

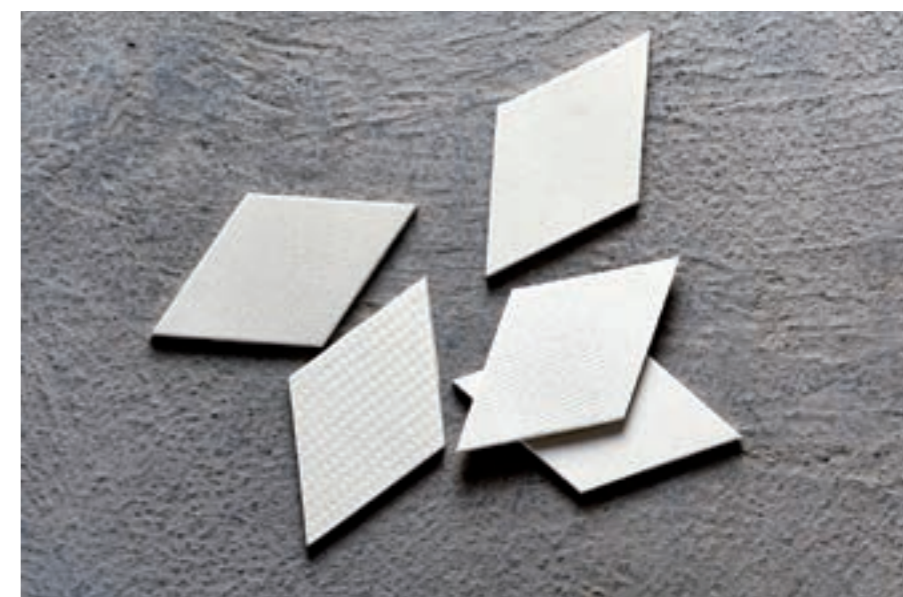

5 texture miscelate random - 5 textures mixed randomly



8 colori - 8 colours

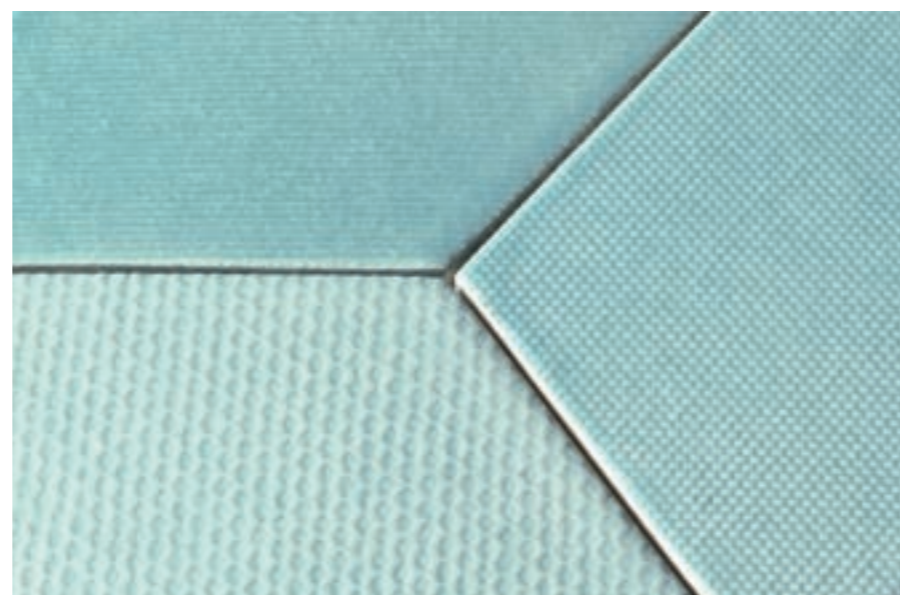

3 tonalità per ogni colore - 3 shades four each colour

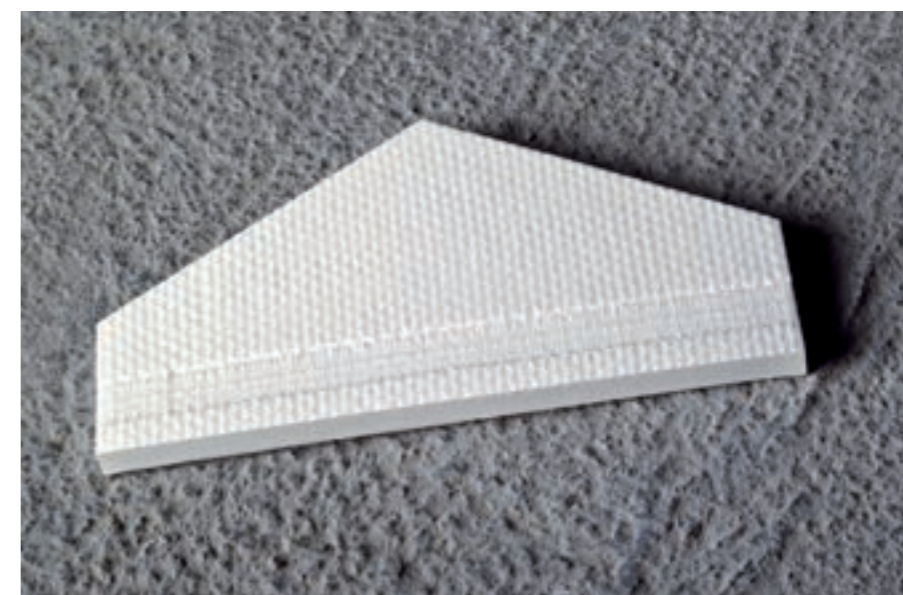

1 elemento battiscopa - 1 skirting element



3 schemi di posa differenti - 3 main laying patterns

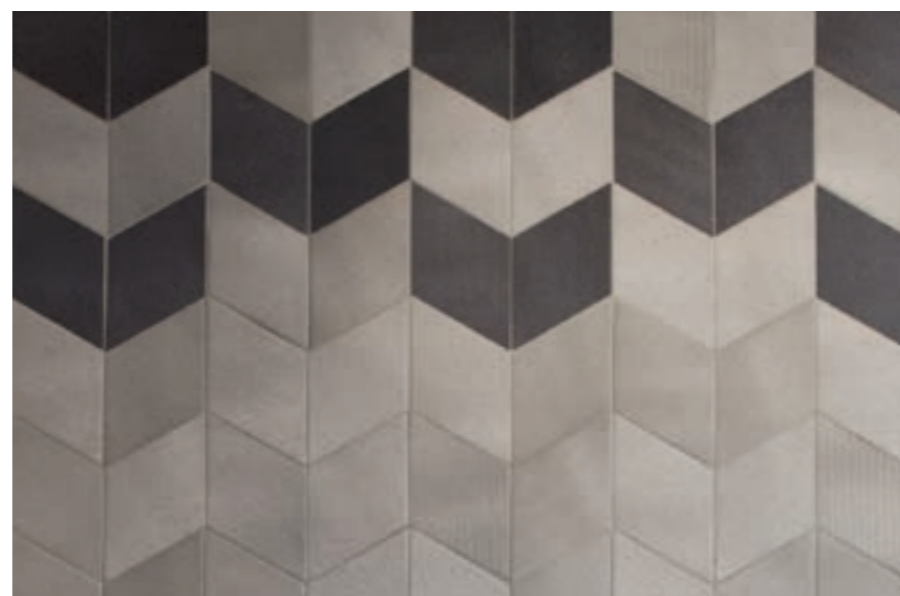

ALL TEX



TEX / white - cream - yellow



TEX / white - cream - yellow



TEX / olive - black battiscopa



TEX / black



TEX / grey - black

TEX

/ grey - black





TEX / cream - blue



TEX

/ cream - blue - cream battiscopa



TEX

/ yellow - white - white battiscopa





TEX / blue - cream - white - blue battiscopa



TEX

/ blue - cream - white - blue battiscopa

RAW EDGES

Nati a Tel Aviv, Yael Mer e Shay Alkalay hanno studiato alla Bezalel Art & Design Academy di Gerusalemme per poi approdare a Londra, dove, dopo il diploma al Royal College of Art nel 2006, hanno fondato il Raw-Edges Design Studio. Yael ama piegare come fogli sottili strati dei materiali piú vari, generando volumi curvi e forme funzionali. Shay ha un profondo interesse per il modo in cui le cose si muovono, funzionano e interagiscono. I due diversi approcci convergono nella creazione di progetti inediti, frutto di una spiccata sensibilità ambientale. Il 2009 è stato un anno importante: oltre a ricevere l'Elle Decoration International Design Award per Stack di Established & Sons, nella sezione Furniture, a Design Miami/Basel sono stati insigniti del Designers of the Future Award 2009. Collaborano con diversi produttori e brand internazionali come Cappellini, Established & Sons, Moroso, Kvadrat, Stella McCartney, Arco, Golran, Moustache and Lema. I loro lavori sono presenti nelle collezioni permanenti del MoMA di New York e altri musei a livello internazionale. Occasionalmente Yael e Shay producono limited edition e installazioni basate su esperimenti sviluppati all'interno del loro studio londinese. Nel 2015, il duo ha presentato una nuova installazione su larga scala alla Chatsworth House, dove colorati pavimenti macchiati ricoprono la galleria di sculture e sedute dal pattern legnoso crescono dal pavimento.

Both born in Tel Aviv in 1976, Yael Mer and Shay Alkalay studied at the Bezalel Art & Design Academy in Jerusalem before moving to London, where after obtaining a diploma from the Royal College of Art in 2006, they founded the Raw Edges Design Studio. Yael likes to fold slim layers of all sorts of material creating curved volumes and functional forms. Shay has a passionate interest in the way things move, function and interact. These two different approaches come together to create a series of original projects, resulting from a strong environmental awareness. 2009 was an important year: in addition to the Elle Decoration International Design Award for Stack by Established & Sons, in the Furniture section, at Design Miami/Basel the duo received the Designers of the Future Award 2009. They work with a number of international brands and producers, such as Cappellini, Established & Sons, Moroso, Kvadrat, Stella McCartney, Arco, Golran, Moustache and Lema. Their works can be found within the permanent collections of the MoMA in New-York and in other museums internationally. In addition, Yael and Shay produce from time to time unique and limited-edition designs and installations, usually based on experiments they develop within their London studio. In 2015 the duo will present a new large scale installation at Chatsworth House, where colorful stained floors cover the sculpture gallery and where wooden patterned seats grow from the ground.

Tex collection winner of

INTERIOR INNOVATION AWARD 2014



TEX

sizes

colours

technical features

packing

La collezione Tex rientra nella tipologia dei prodotti “artisanal” di Mutina. Prodotta per estrusione e tagliata a crudo, presenta cinque diverse texture ottenute imprimendo sulla superficie dei disegni a rilievo. Viene poi smaltata attraverso un processo automatico che consente di realizzare per ciascun colore tre toni in ugual percentuale prima di indirizzarla verso un ciclo di cottura in cui si raggiungono temperature fino a 1.100°. Il prodotto così ottenuto presenta una superficie assolutamente opaca, leggermente strutturata ma morbidissima al tatto, facile da pulire perché pensata all’utilizzo sia a rivestimento che a pavimento. Ciascun rombo in formato 11,5x20cm ed avente spessore 10mm, pur presentando piccole irregolarità dimensionali volute dai designer, si posa agevolmente accostando le piastrelle l’un l’altra e stuccando le fughe in tono su tono. La serie Tex rappresenta un ottimo risultato ottenuto combinando una produzione interamente artigianale e le più moderne tecnologie di applicazione e definizione del colore.

Tex collection is part of the “handmade” products range by Mutina. It is produced by extrusion and then raw cut. It presents 5 different textures, obtained by pressing on the surface relief-patterns. The tile is then glazed using an automatic process which enables the realization in the same percentage of 3 different shades for each color. The tile finally undergoes a baking process which reaches temperatures up to 1.100°. The obtained product has an absolutely matt surface, slightly structured but very soft to the touch, which is also very easy to clean since thought both for wall and floor covering. Each rhombus in size 11,5x20cm and with thickness 10mm, is easily fixed pulling the tiles close to each other and using a matching grout, even if they have some small size irregularities made on purpose by the designers. Tex collection reaches a perfect result obtained combining a completely handmade production to the newest technologies for the application and definition of the color.

TEX / sizes

design Raw Edges 2012

production artisanal

material impasto trafilato smaltato - glazed extruded body

thickness 10

*misure nominali - nominal sizes



11,5-20
* 4 1/2" - 8"

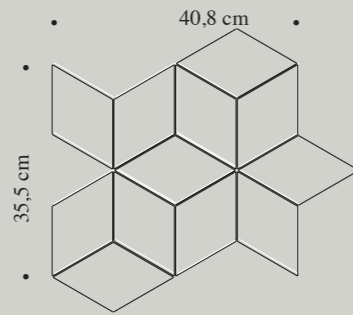

runner 40,8-35,5
* 16 1/16" - 13 31/32"

complementary pieces

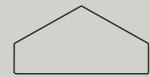

10,5-20
* 4 1/8" - 8"
battiscopa - skirting

TEX / colours

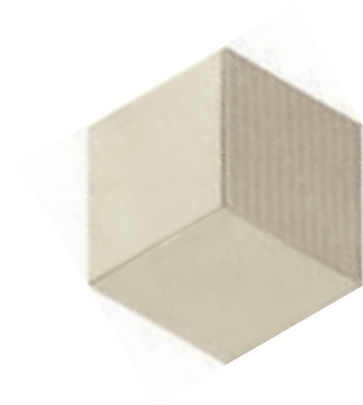

cream

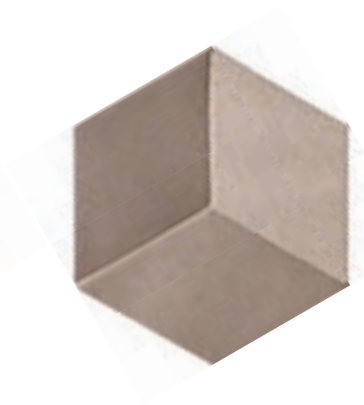

brown



white



grey

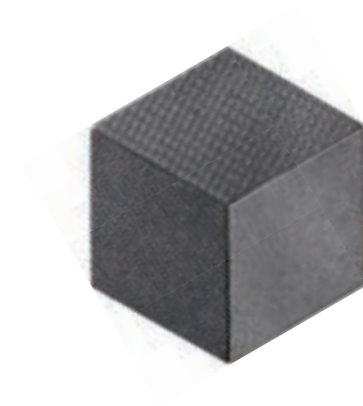

black

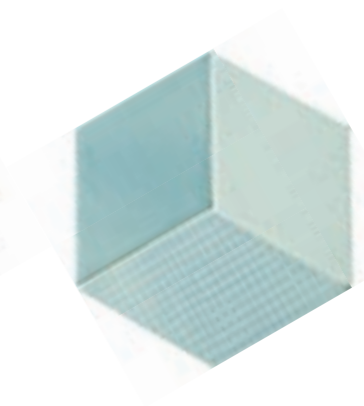

blue

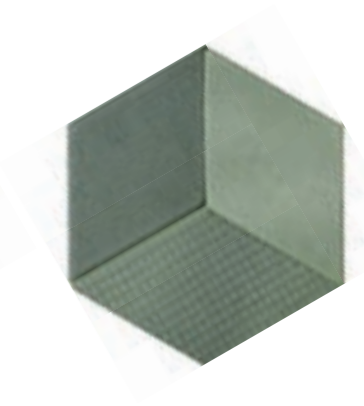

olive



yellow

TEX / runner

Il Runner è un elemento composto da 12 rombi di vari colori già posati su rete per la realizzazione facilitata di svariate decorazioni.

The Runner is an element composed by 12 rhombus of different colours already set on mesh, so to make the realization of several decors easier.

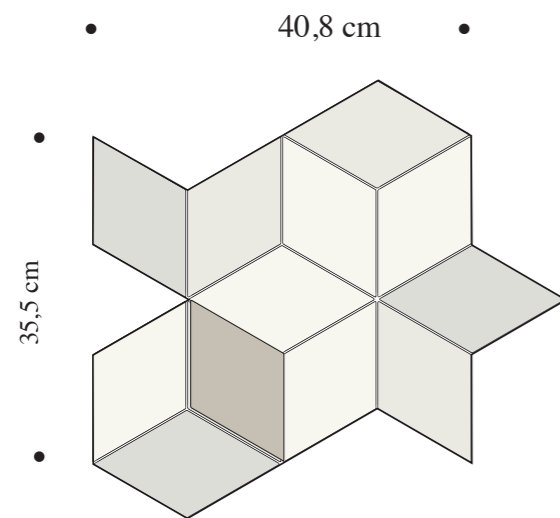

Ogni Runner è composto da 8 moduli diversi, non vendibili separatamente ed inclusi in un unico imballo, che permettono di creare molteplici combinazioni.

Each Runner is composed by 8 different patterns, not singularly sold and already included in one single package, which enable the realization of many combinations.

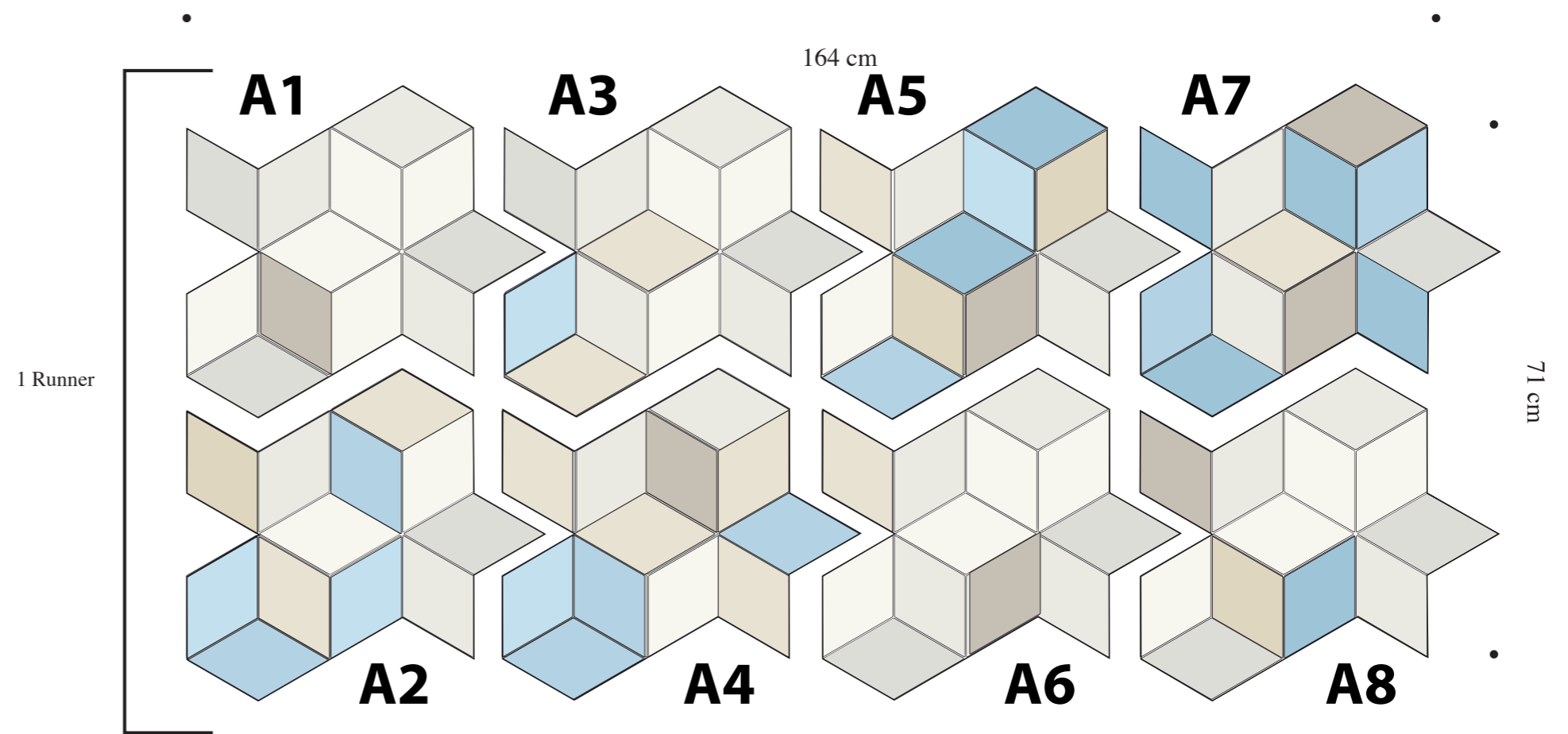

1 Runner = 8 moduli = 1,12 mq - 1 Runner = 8 patterns = 1,12 sqm

Esistono 10 Runner: ognuno abbinato a ciascun colore della collezione, per il colore white ce ne sono 3.

There are 10 Runners, each of which combined to every colour of the collection. For the white one there are 3 of them.

TEX / runner colours

10 Runner, ognuno composto da 8 moduli diversi, in abbinamento ai colori della collezione.

10 Runners, each of which is composed by 8 different patterns, matching with the colours of the collection.

RUNNER 1 WHITE
(white + yellow & cream)

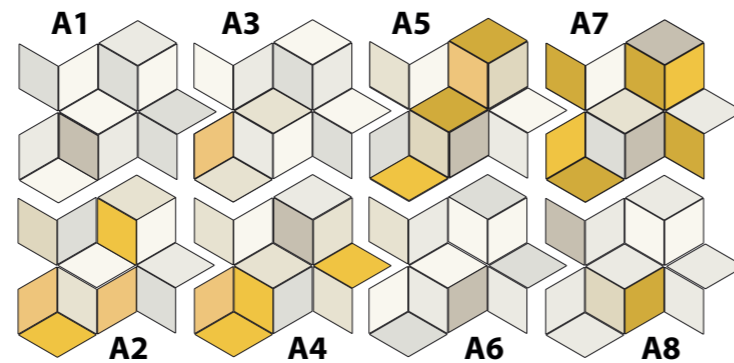

runner 4 CREAM
(cream + brown & white)

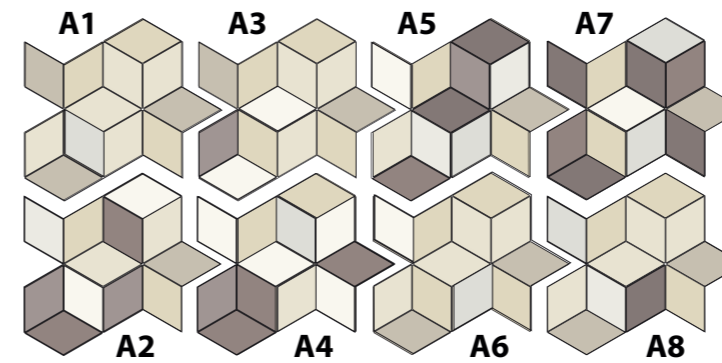

runner 7 BLACK
(black + grey & white)

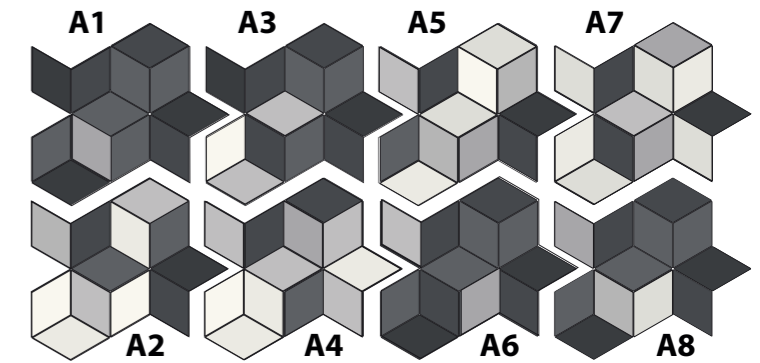

runner 8 OLIVE
(olive + cream & white)

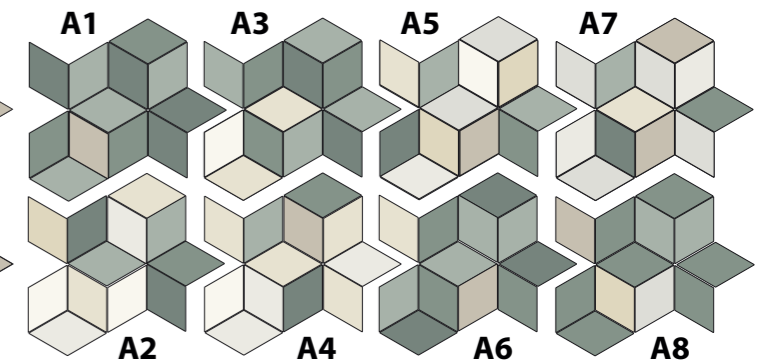

runner 2 WHITE
(white + olive & cream)

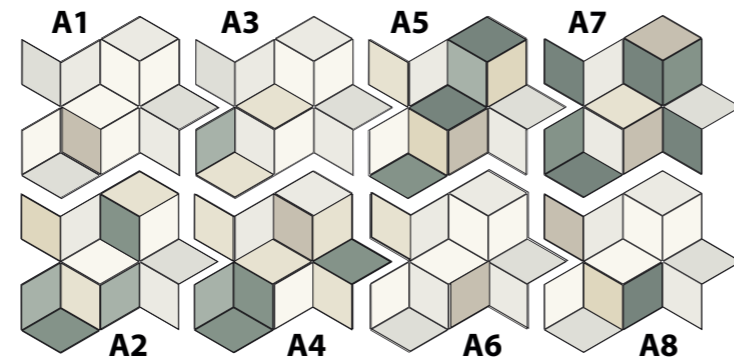

runner 5 BROWN
(brown + cream & white)

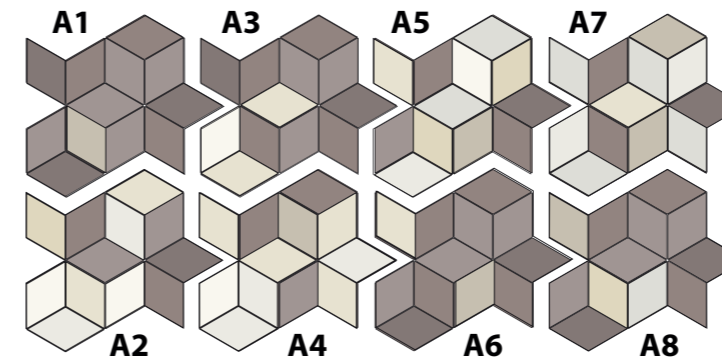

runner 9 BLUE
(blue + cream & white)

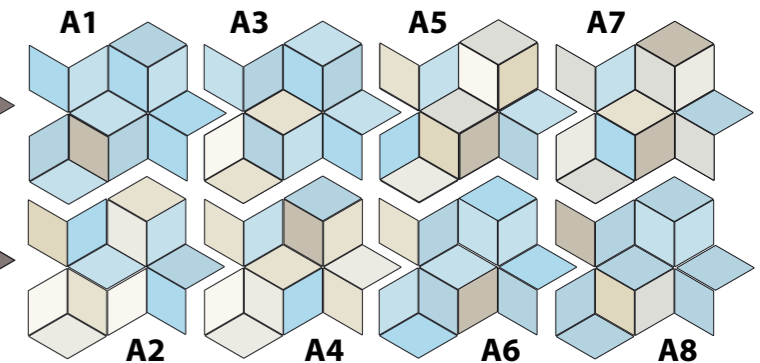

runner 3 WHITE
(white + blue & cream)

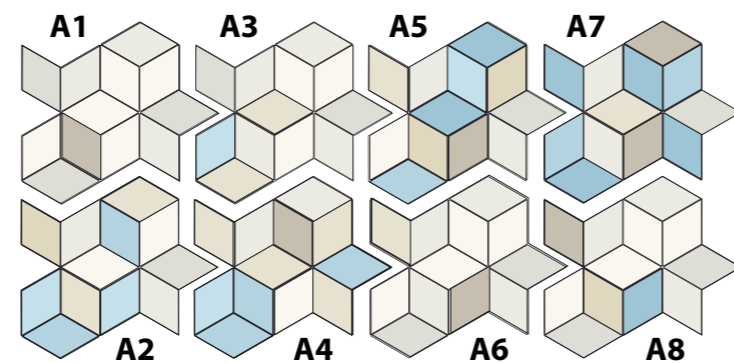

runner 6 GREY
(grey + cream & white)

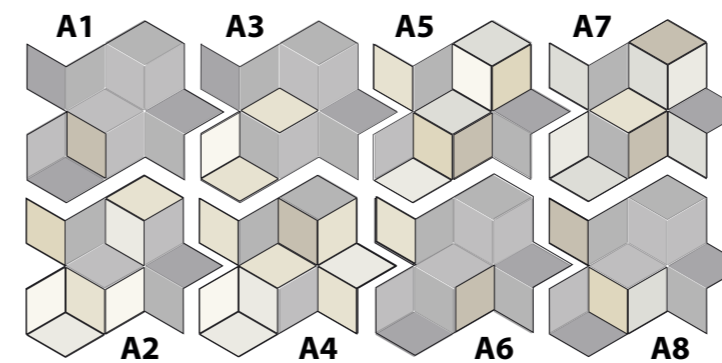

runner 10 YELLOW
(yellow + cream & white)

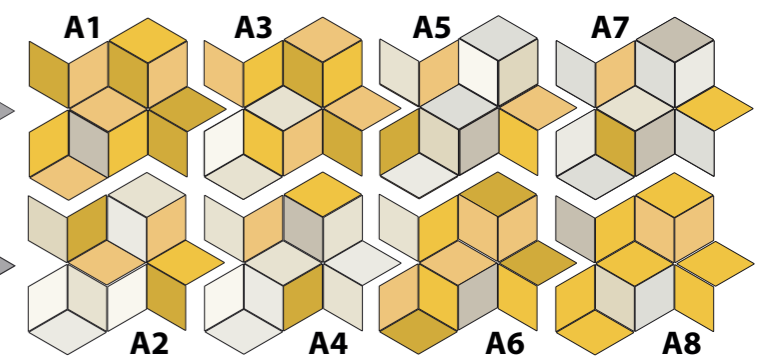

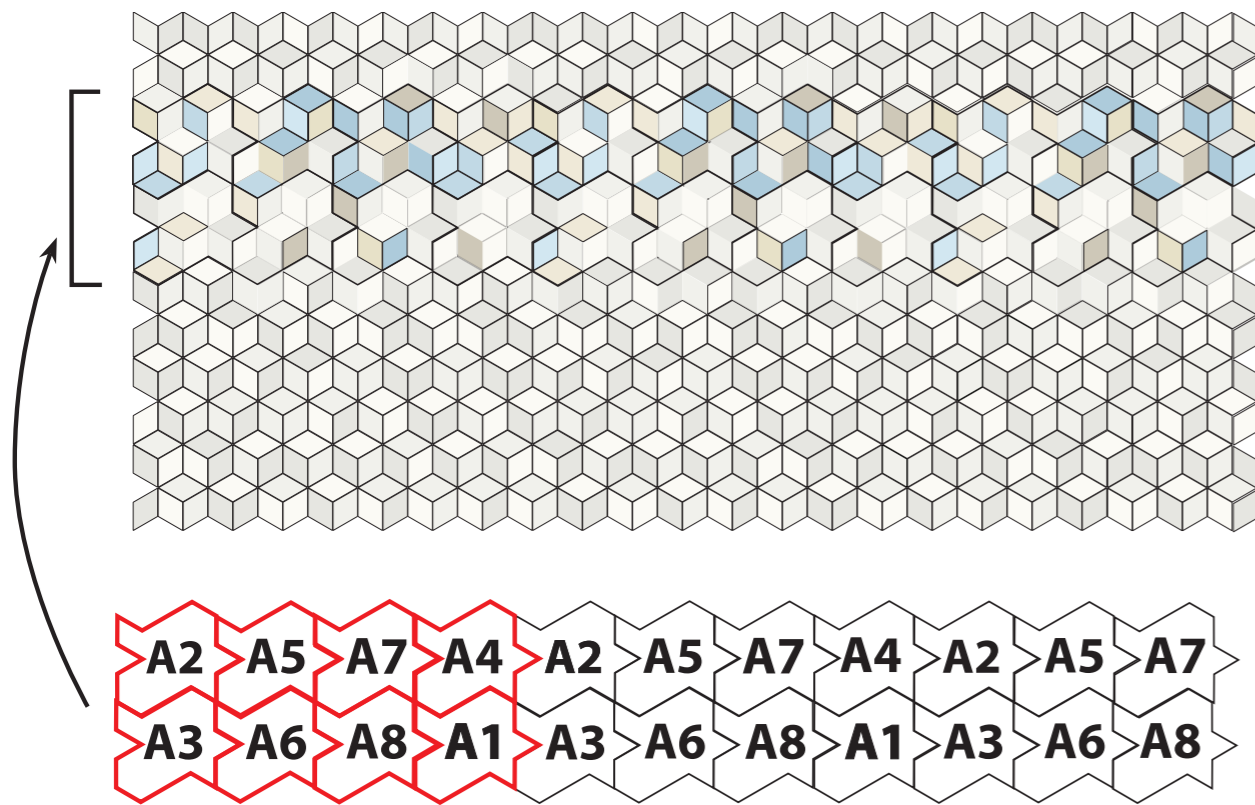

Esempio di posa 1 - Laying scheme 1
 Composizione singola - Single composition

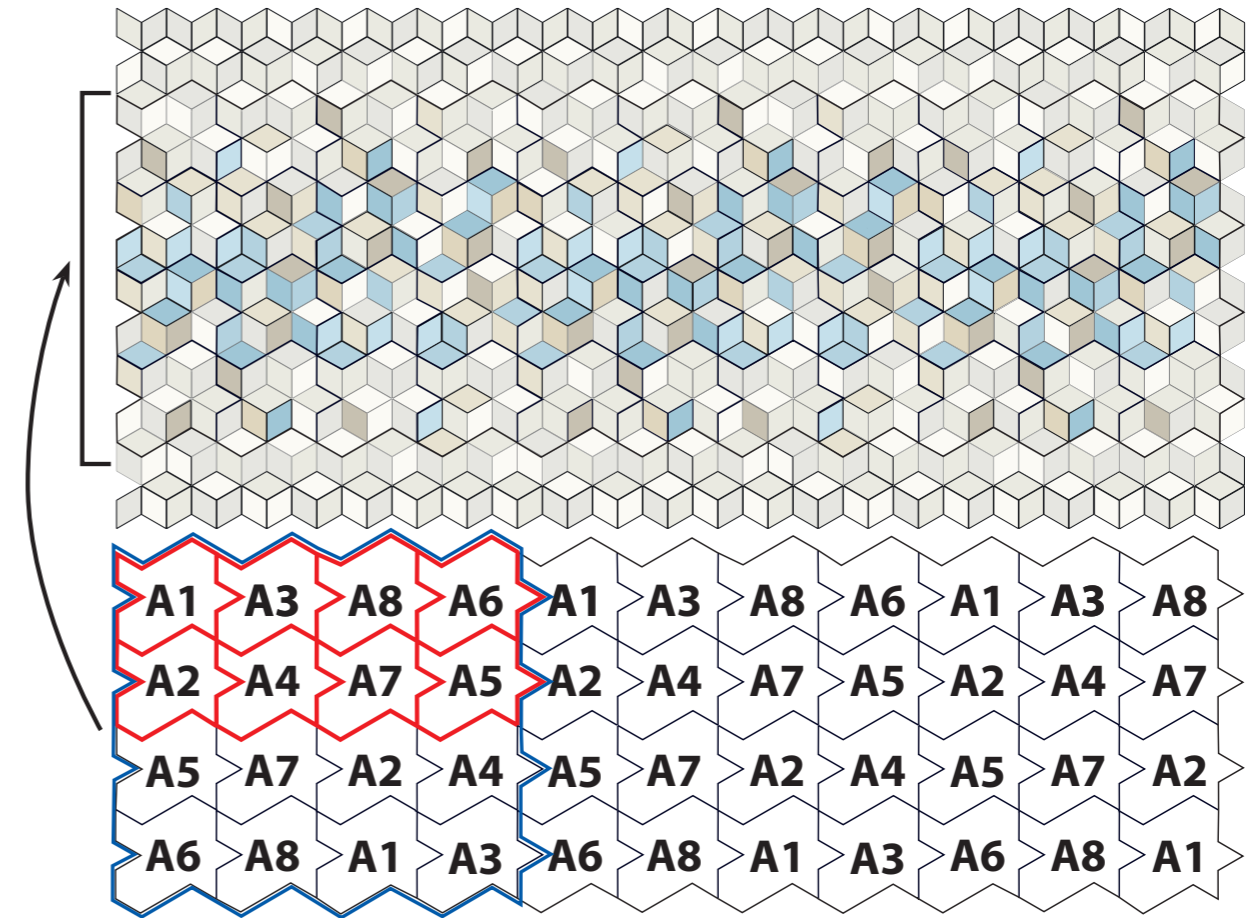

Esempio di posa 2 - Laying scheme 2
 Composizione doppia - Double composition

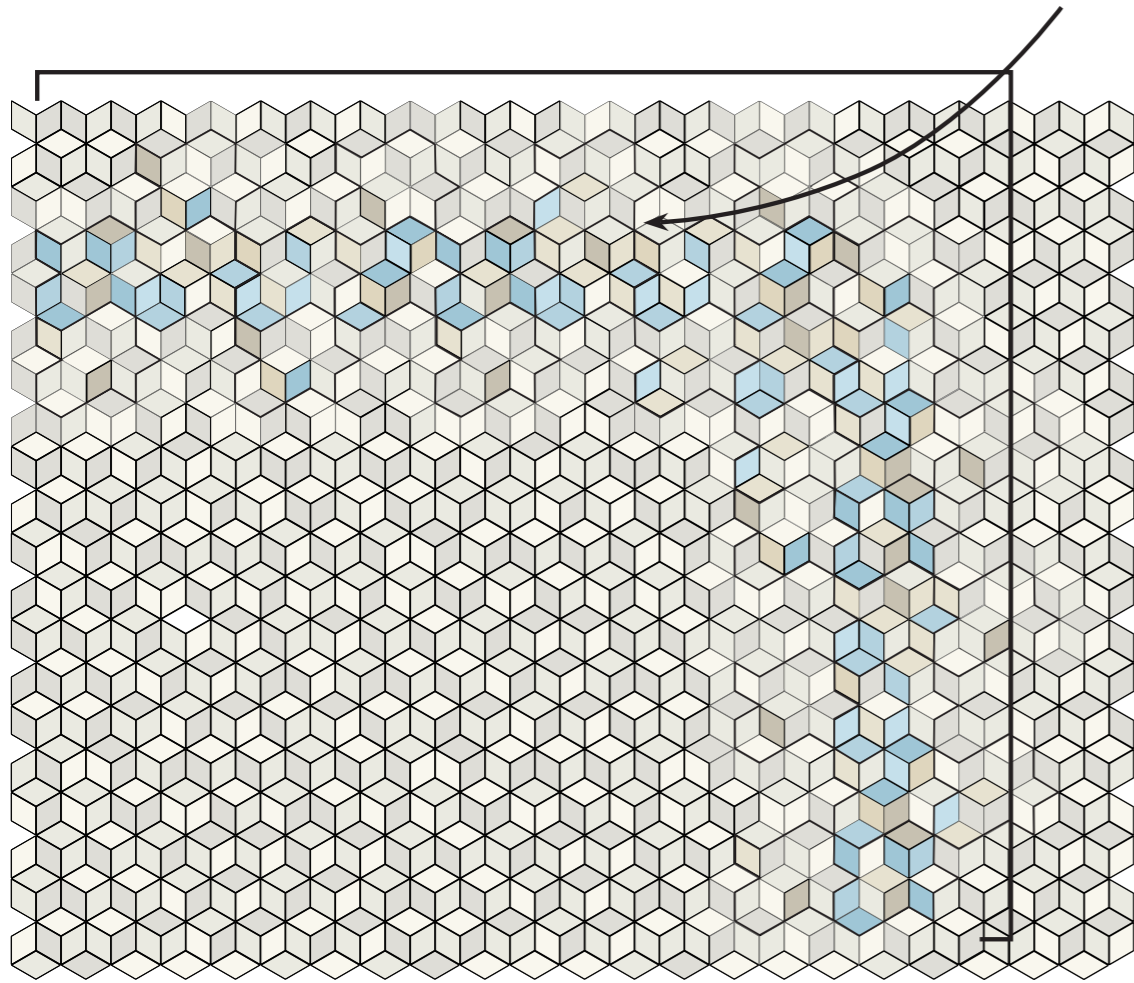
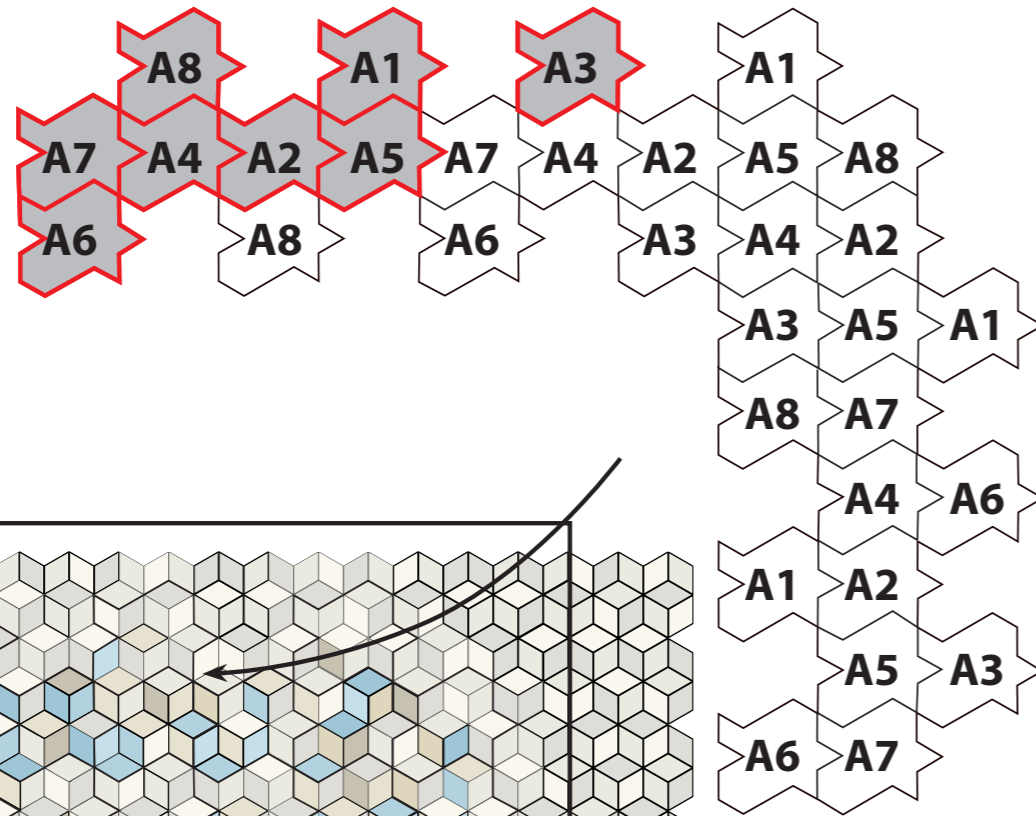

Esempio di posa 3 - Laying scheme 3

Composizione libera - Free composition

TEX / technical features

AIII GROUP

norma standard	caratteristiche features	valore prescritto value required	tex
EN 101	durezza superficiale (scala mohs) surface hardness (scala mohs)	> 5	6
ISO 10545/9	resistenza agli sbalzi termici resistance to thermal shock	nessuna alterazione visibile no visible alteration	resiste resistant
ASTM C484		no samples must show visible defects	unaffected
ISO 10545/13	resistenza agli attacchi chimici resistance to chemical attacks	nessuna alterazione visibile no visible alteration	resiste GA - GLA - GHA resistant GA - GLA - GHA
ASTM C650			unaffected
ISO 10545/4	resistenza alla flessione breaking strength	≥12 N/mm2	26,9 N/mm2
DIN 51130 - 04		valori medi 6° ÷ 10° 10° ÷ 19° 19° ÷ 27°	R9 R10 R11
ASTM C1028	scivolosità anti-slip	> 0,60	dry neolite 0,82 wet neolite 0,71
BCRA	scivolosità anti-slip	> 0,40	leather on dry surface 0,63 rub on wet surface 0,56
ISO 10545/14	resistenza alle macchie stains resistance	≥ classe 3	5

TEX / packing

formato size	pz-mq pcs-sqm	pz-scat. pcs-box	mq-scat. sqm-box	scat.-pal. box-pal.	kg-scat. kg-box	kg-pal. kg-pal.	mq-pal sqms-pal
11,5-20	86,96	44	0,51	88	9,81	864	44,88
runner 50-46	0,91 set	1 set*	1,12	36	21,41	771	40,32
battiscopa 10,5-20	-	10	2,0 ml	-	3,00	-	-

*1 set = 8 pcs



credits

art direction Patricia Urquiola

photos Alessandro Paderni/EYE studio

styling Raw Edges

graphic project Simona Bernardi

text Raw Edges

thanks to:

Arco

Cappellini

Fantini

Il te delle 5

Alessandro Pietri

Printed and bound in Italy. September 2015.

All the rights are reserved. Not any part of this work can be reproduced in any way without the preventive written authorization by Mutina.

All work is copyrighted © to their respective owners.

CERAMICHE MUTINA SPA

Via Ghiarola Nuova 16

41042 Fiorano MO

Italia

+ 39 0536 812800 T

+ 39 0536 812808 F

mutina.it

