

# Homey

PREVIEW

7 COLOURS

4 SIZES

1 SURFACE

Today more than ever we perceive how important it is to have a comfortable and cozy home. Our safe place where to find peace, tranquility and love. The Homey collection is ideal to create a homey house through its warm materiality.

Mai come in questo momento percepiamo quanto sia importante avere una casa confortevole e accogliente. Il nostro luogo sicuro dove trovare pace, tranquillità e amore. La collezione Homey è ideale per creare attraverso la sua calda matericità una casa gradevole e ospitale.

Niemals mehr als in diesem Moment sind wir uns bewusst, wie wichtig es ist, ein komfortables und einladendes Zuhause zu haben. Unser sicherer Ort, um Frieden, Ruhe und Liebe zu finden. Die Homey-Kollektion ist durch ihre warme Materialität ideal, um ein angenehmes und gemütliches Zuhause zu schaffen.

Jamais comme en ce moment nous ne percevons combien il est important d'avoir une maison confortable et accueillante. Notre endroit sûr pour trouver la paix, la tranquillité et l'amour. La collection Homey est idéale pour créer une maison agréable grâce à sa matérialité chaude.

## Homey



Tecnologia e Superfici  
Technology & Surfaces

P. 4

Spazi Residenziali  
Residential Spaces

P. 9

Informazioni Tecniche  
Technical Information

P. 27



La serie Homey è ispirata all'idea di ottenere superfici dall'aspetto naturale prendendo spunto dalla terra, nello specifico l'argilla con i suoi colori caldi e le sfumature 'ton sur ton' ottenendo una superficie morbida, ideale per una casa calda e confortevole.

Dall'argilla, pressata in forme stabilite, asciugata e cotta vengono creati i laterizi di vari ornamenti architettonici utilizzati in edilizia.

La collezione Homey trae ispirazione da queste forme di laterizio e propone una struttura a mattoncini sia in versione naturale che smaltata lucida.



The Homey series is inspired by the idea of obtaining natural-looking surfaces inspired by the earth, specifically clay with its warm colors and shades 'ton sur ton' obtaining a soft surface, ideal for a warm and cozy home. From the clay, pressed in established forms, then dried and fired, are created the bricks of various architectural ornaments used in construction.

The Homey collection draws inspiration from these brick shapes and presents a structure in both natural and glossy finish.

Die Homey-Serie ist von der Idee inspiriert, natürlich aussehende Oberflächen zu erhalten, die sich von der Erde inspirieren lassen, insbesondere die Tonerde mit seinen warmen Farb- auf Farbtönen, um eine sanfte Oberfläche zu erhalten, die ideal für ein warmes und komfortables Zuhause ist.

Aus dem fest gepressten Ton, der anschliessend getrocknet und gebrannt wird, entstehen die Ziegelsteine verschiedener architektonischer Ornamente, die im Bauwesen verwendet werden.

Die Homey-Kollektion ist von diesen Ziegelformen inspiriert und bietet eine Ziegelstruktur sowohl in natürlicher als auch in glänzend glasierter Ausführung.

La série Homey est inspirée par l'idée d'obtenir des surfaces à l'aspect naturel en s'inspirant de la terre, en particulier l'argile avec ses couleurs chaudes et les nuances 'ton sur ton' en obtenant une surface douce, idéale pour une maison chaude et confortable.

À partir de l'argile pressée dans des formes établies, séchée et cuite, des briques de divers ornements architecturaux utilisés dans la construction sont créées.

La collection Homey s'inspire de ces formes de briques et propose une structure en briques aussi bien en version naturelle qu'en émail brillant.

## Superficie Naturale / Natural Surface

Homey has a slightly wavy and opaque texture, capable of creating surfaces that evoke the warm materiality of clay. A contemporary material with the resistance qualities of porcelain stoneware.

Homey hat eine leicht bewegte und matte Textur, die in der Lage ist, Oberflächen zu erzeugen, die an die warme Textur von Tonerde erinnern. Ein zeitgemäßes Material mit den Festigkeitseigenschaften von Feinsteinzeug.

Homey a une texture légèrement ondulée et mate, capable de créer des surfaces qui évoquent la matière chaude de l'argile. Une matière contemporaine avec de qualités de résistance propres au grès cérame.

Homey ha una texture lievemente mossata e opaca, capace di creare superfici che evocano la calda matericità dell'argilla. Una materia contemporanea con le qualità di resistenza proprie del gres porcellanato.

60x120 - 24"x48" Cotto Naturale Rettificato



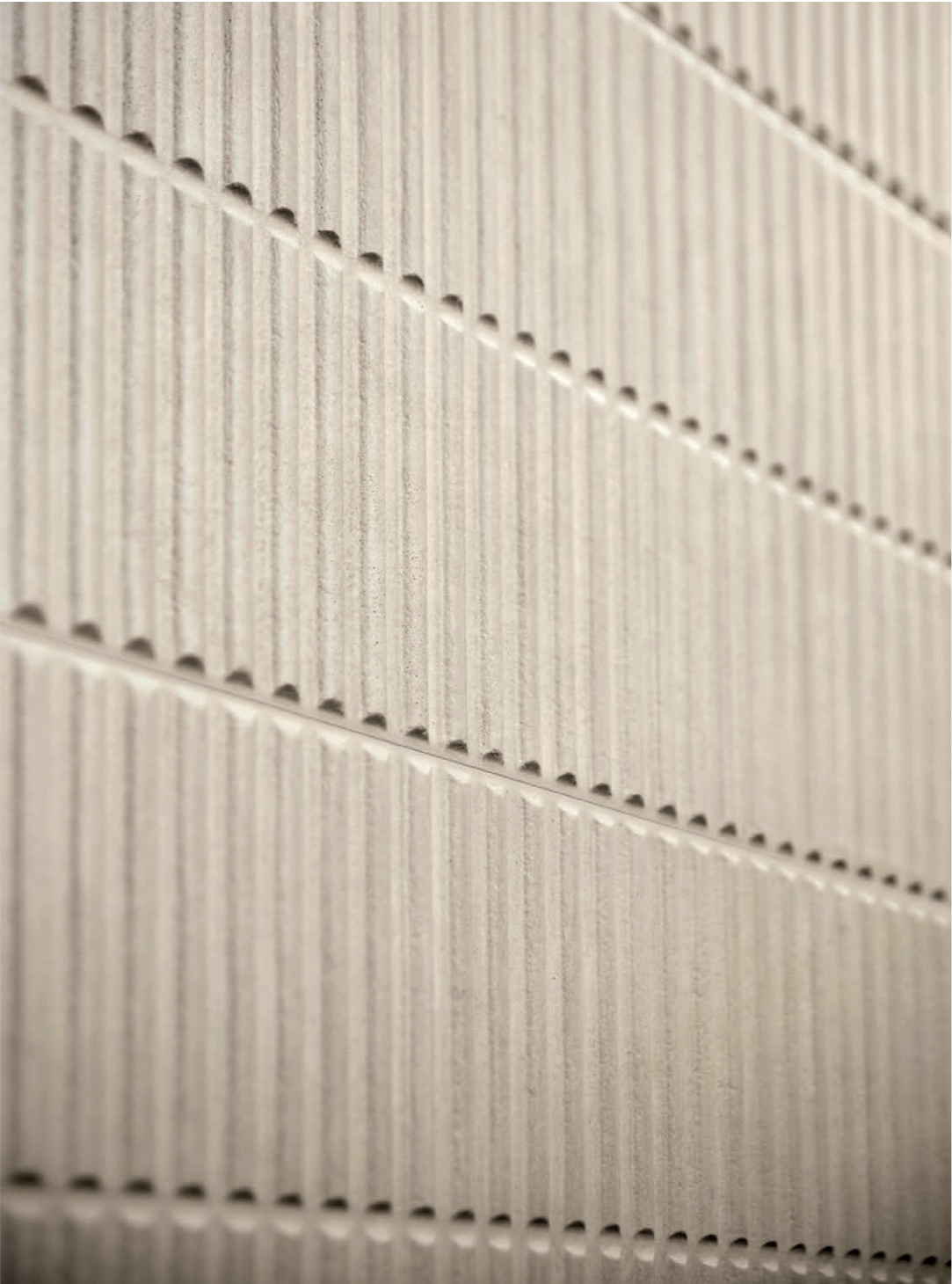

# Spazi Residenziali

Residential Spaces  
Wohnanlagen  
Espaces Résidentiels



COLORI / COLOURS

AMBIENTI / AMBIENT

PAGINA / PAGE

Cotto / Taupe / Stripes Powder Mat	Living	10
Taupe / Cotto / Stripes White - Clay Mat	Dining	12
Chalk / Berry / Stripes Grey Mat	Kitchen	16
Chalk / Sage / Stripes White Mat	Bedroom	18
Cloudy / Dove	Bathroom	22







## Flower Cotto

Free interpretations of original and dynamic flooring surfaces that furnish every space. The ideal floral pattern for homey and contemporary environments.

Freie Interpretationen origineller und dynamischer Bodenbeläge, die jeden Raum einrichten. Das ideale Blumenmotiv für warme, komfortable und moderne Umgebungen.

Interprétations libres des surfaces pour les sols originaux et dynamiques qui meublent chaque espace. Le motif floral idéal pour les environnements chauds, confortables et contemporains.

Libere interpretazioni di superfici per pavimentazioni originali e dinamiche che arredano ogni spazio. Il motivo floreale è ideale per ambienti caldi, confortevoli e contemporanei.

60x120 - 24"x48" Flower Cotto Naturale Rettificato



Honey  
Residential Spaces

Chalk / Berry / Stripes Grey Mat



60x120 - 24"x48" Berry Naturale Rettificato  
30x60 - 12"x24" Stripes Grey Mat Naturale Rettificato

60x120 - 24"x48" Flower Chalk Naturale Rettificato  
60x60- 24"x24" Chalk Naturale Rettificato









Dove / Stripes Mustard Glossy  
Cloudy / Stripes Blue Glossy

30x60 - 12"x24" Stripes Mustard Glossy Rettificato  
120x120 - 48"x48" / 60x120 - 24"x48" Dove Naturale Rettificato



30x60 - 12"x24" Stripes Blue Glossy Rettificato

120x120 - 48"x48" Cloudy Naturale Rettificato



# Informazioni Tecniche

7

Colori  
Colours  
Farben  
Couleurs

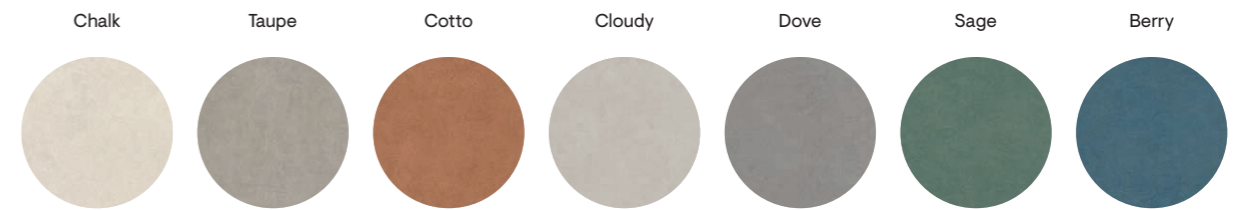

4

Formati  
Sizes  
Formate  
Formats

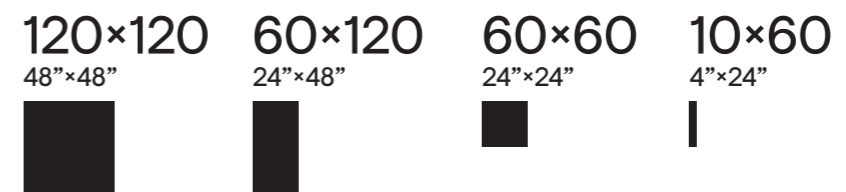

2

Spessori  
Thickness  
Stärke  
Epaisseur

±9      ±9,5

1

Superfici  
Surfaces  
Oberflächen  
Surfaces

Naturale

1

Strutture 3D  
3D structures  
Strukturen  
Décorations en relief

30x60  
12x24

8

Colori  
Colours  
Farben  
Couleurs



i

Effetto Argilla  
Clay Look  
Tonoptik  
Effet Argile

Rivestimento  
Wall Tiles  
Wandfliesen  
Revêtement

Pavimento  
Floor Tiles  
Bodenfliesen  
Sol

Gres fine porcellanato ad impasto colorato  
Coloured-body fine porcelain stoneware  
Feinsteinzeug aus farbiger Masse  
Grès cérame fin à pâte colorée

Tecnologia digitale  
Digital technology  
Digital technologie  
Technologie numérique



Gres fine porcellanato ad impasto colorato  
Tecnologia Digitale

Coloured-body fine porcelain stoneware  
Digital Technology

Feinsteinzeug aus farbiger Masse  
Digital Technologie

Grès cérame fin à pâte colorée  
Technologie Numérique

# Chalk

Per un risultato di posa ottimale si consiglia di prelevare le piastrelle da 5/6 scatole contemporaneamente.

For best installation results, we suggest taking the tiles from 5/6 boxes at the same time.



± 9

120×120 - 48"×48"

**05245** | Homey Chalk Nat/Ret



± 9,5

60×120 - 24"×48"

**05216** | Homey Chalk Nat/Ret

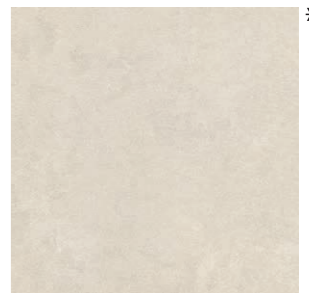

± 9,5

60×60 - 24"×24"

**05224** | Homey Chalk Nat/Ret



60×120 - 24"×48"

**05243** | Homey Rammed Cold Nat/Ret



60×120 - 24"×48"

**05276** | Homey Bloom White Nat/Ret

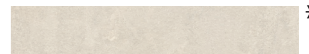

± 9,5

10×60 - 4"×24"

**05277** | Homey Chalk Nat/Ret



60×120 - 24"×48"

**05244** | Homey Rammed Warm Nat/Ret

Pezzi speciali  
Special pieces



Battiscopa 4,5×60 ± 9,5

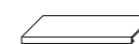

Gradino Costa Retta 33×120 ± 9,5





# Taupe

Per un risultato di posa ottimale si consiglia di prelevare le piastrelle da 5/6 scatole contemporaneamente.

For best installation results, we suggest taking the tiles from 5/6 boxes at the same time.

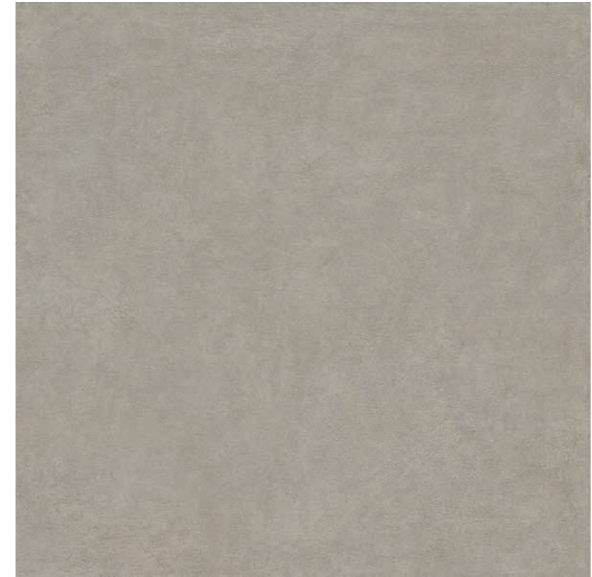

± 9

120×120 - 48"×48"

05248 | Homey Taupe Nat/Ret



± 9,5

60×120 - 24"×48"

05219 | Homey Taupe Nat/Ret



± 9,5

60×60 - 24"×24"

05227 | Homey Taupe Nat/Ret



60×120 - 24"×48"

05243 | Homey Rammed Cold Nat/Ret

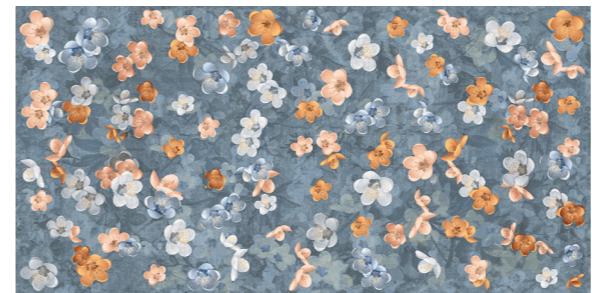

60×120 - 24"×48"

05275 | Homey Bloom Blue Nat/Ret



± 9,5

10×60 - 4"×24"

05280 | Homey Taupe Nat/Ret

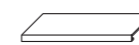



Gres fine porcellanato ad impasto colorato  
Tecnologia Digitale

Coloured-body fine porcelain stoneware  
Digital Technology

Feinsteinzeug aus farbiger Masse  
Digital Technologie

Grès cérame fin à pâte colorée  
Technologie Numérique

# Cotto

Per un risultato di posa ottimale si consiglia di prelevare le piastrelle da 5/6 scatole contemporaneamente.

For best installation results, we suggest taking the tiles from 5/6 boxes at the same time.



€ 9

120x120 - 48"x48"

05249 | Homey Cotto Nat/Ret



€ 9,5

60x120 - 24"x48"

05221 | Homey Cotto Nat/Ret



€ 9,5

60x60 - 24"x24"

05228 | Homey Cotto Nat/Ret



60x120 - 24"x48"

05244 | Homey Rammed Warm Nat/Ret



€ 9,5

10x60 - 4"x24"

05281 | Homey Cotto Nat/Ret



60x120 - 24"x48"

05241 | Homey Flower Cotto Nat/Ret

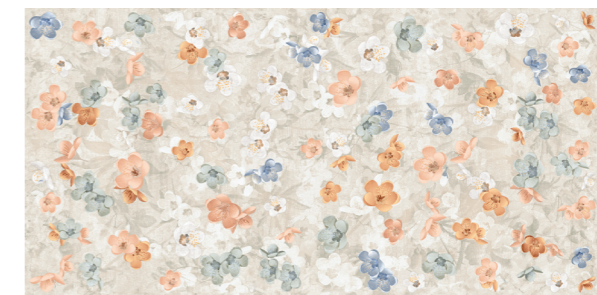

60x120 - 24"x48"

05276 | Homey Bloom White Nat/Ret

Pezzi speciali  
Special pieces



Battiscopa 4,5x60 € 9,5

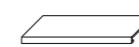

Gradino Costa Retta 33x120 € 9,5



Gres fine porcellanato ad impasto colorato  
Tecnologia Digitale

Coloured-body fine porcelain stoneware  
Digital Technology

Feinsteinzeug aus farbiger Masse  
Digital Technologie

Grès cérame fin à pâte colorée  
Technologie Numérique

# Cloudy

Per un risultato di posa ottimale si consiglia di prelevare le piastrelle da 5/6 scatole contemporaneamente.

For best installation results, we suggest taking the tiles from 5/6 boxes at the same time.

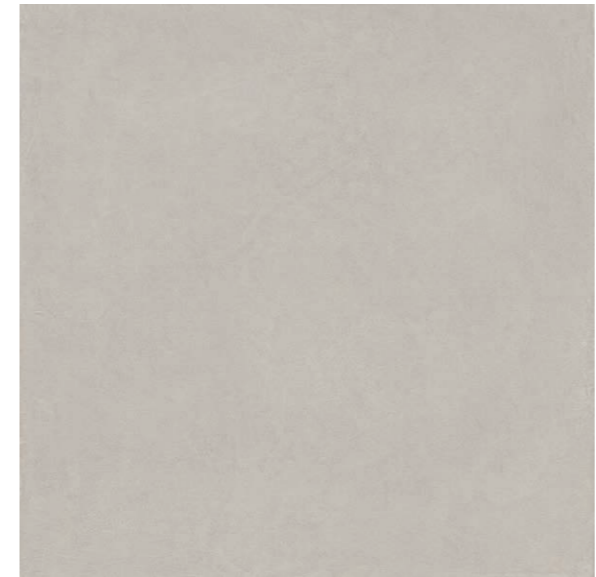

± 9

120×120 - 48"×48"

05246 | Homey Cloudy Nat/Ret



± 9,5

60×120 - 24"×48"

05217 | Homey Cloudy Nat/Ret



± 9,5

60×60 - 24"×24"

05225 | Homey Cloudy Nat/Ret



60×120 - 24"×48"

05243 | Homey Rammed Cold Nat/Ret

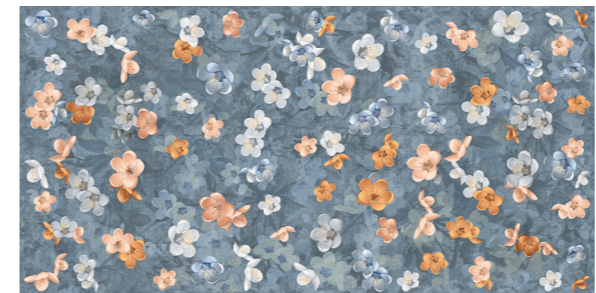

60×120 - 24"×48"

05275 | Homey Bloom Blue Nat/Ret

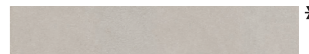

± 9,5

10×60 - 4"×24"

05278 | Homey Cloudy Nat/Ret

Pezzi speciali  
Special pieces



Battiscopa 4,5×60 ± 9,5

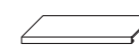

Gradino Costa Retta 33×120 ± 9,5



Gres fine porcellanato ad impasto colorato  
Tecnologia Digitale

Coloured-body fine porcelain stoneware  
Digital Technology

Feinsteinzeug aus farbiger Masse  
Digital Technologie

Grès cérame fin à pâte colorée  
Technologie Numérique

# Dove

Per un risultato di posa ottimale si consiglia di prelevare le piastrelle da 5/6 scatole contemporaneamente.

For best installation results, we suggest taking the tiles from 5/6 boxes at the same time.

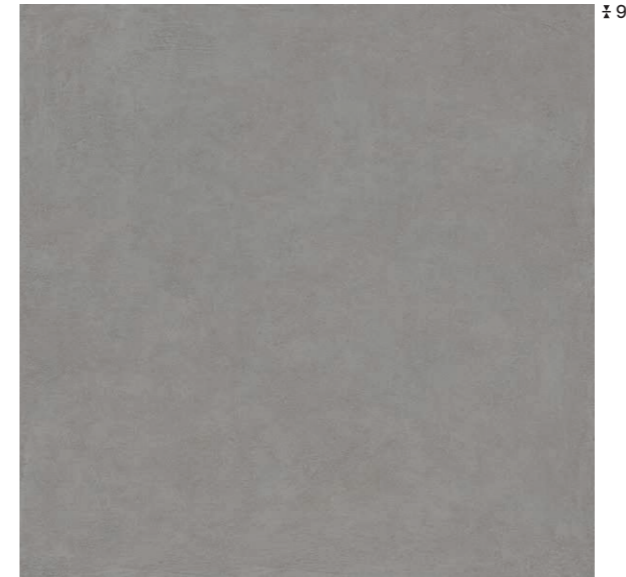

± 9

120×120 - 48"×48"

05247 | Homey Dove Nat/Ret



± 9,5

60×120 - 24"×48"

05218 | Homey Dove Nat/Ret



± 9,5

60×60 - 24"×24"

05226 | Homey Dove Nat/Ret

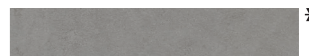

± 9,5

10×60 - 4"×24"

05279 | Homey Dove Nat/Ret



60×120 - 24"×48"

05243 | Homey Rammed Cold Nat/Ret



60×120 - 24"×48"

05242 | Homey Flower Chalk Nat/Ret

Pezzi speciali  
Special pieces



Battiscopa 4,5×60 ± 9,5

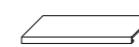

Gradino Costa Retta 33×120 ± 9,5



# Sage

Per un risultato di posa ottimale si consiglia di prelevare le piastrelle da 5/6 scatole contemporaneamente.

For best installation results, we suggest taking the tiles from 5/6 boxes at the same time.



± 9,5

60x120 - 24x48"

05222 | Homey Sage Nat/Ret



± 9,5

60x60 - 24x24"

05229 | Homey Sage Nat/Ret



± 9,5

10x60 - 4x24"

05282 | Homey Sage Nat/Ret



60x120 - 24x48"

05243 | Homey Rammed Cold Nat/Ret



60x120 - 24x48"

05276 | Homey Bloom White Nat/Ret

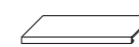



Gres fine porcellanato ad impasto colorato  
Tecnologia Digitale

Coloured-body fine porcelain stoneware  
Digital Technology

Feinsteinzeug aus farbiger Masse  
Digital Technologie

Grès cérame fin à pâte colorée  
Technologie Numérique

# Berry

Per un risultato di posa ottimale si consiglia di prelevare le piastrelle da 5/6 scatole contemporaneamente.

For best installation results, we suggest taking the tiles from 5/6 boxes at the same time.

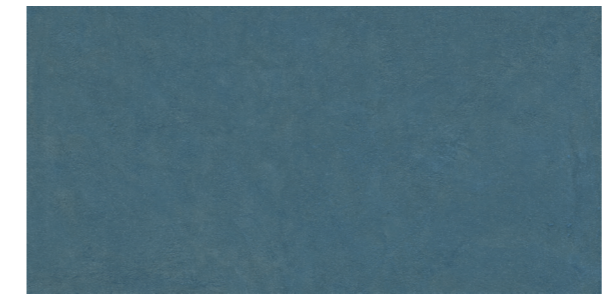

± 9,5

60x120 - 24"x48"

05223 | Homey Berry Nat/Ret



± 9,5

60x60 - 24"x24"

05231 | Homey Berry Nat/Ret



± 9,5

10x60 - 4"x24"

05283 | Homey Berry Nat/Ret

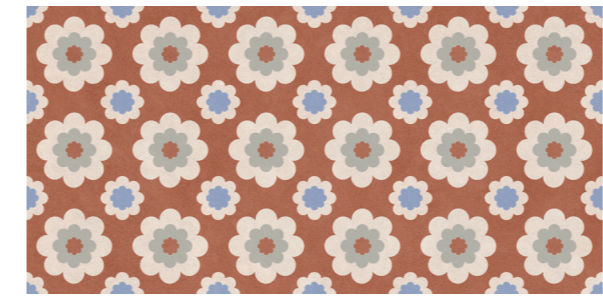

60x120 - 24"x48"

05241 | Homey Flower Cotto Nat/Ret

Pezzi speciali  
Special pieces



Battiscopa 4,5x60 ± 9,5

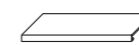

Gradino Costa Retta 33x120 ± 9,5

# Homey Stripes Glossy



30x60 - 12"x24"  
05234 | Homey Stripes White Glossy Ret



30x60 - 12"x24"  
05235 | Homey Stripes Mustard Glossy Ret



30x60 - 12"x24"  
05233 | Homey Stripes Green Glossy Ret



30x60 - 12"x24"  
05232 | Homey Stripes Blue Glossy Ret

# Homey Stripes Mat



30x60 - 12"x24"  
05236 | Homey Stripes White Mat Ret



30x60 - 12"x24"  
05237 | Homey Stripes Powder Mat Ret



30x60 - 12"x24"  
05238 | Homey Stripes Clay Mat Ret



30x60 - 12"x24"  
05239 | Homey Stripes Grey Mat Ret



Glossy

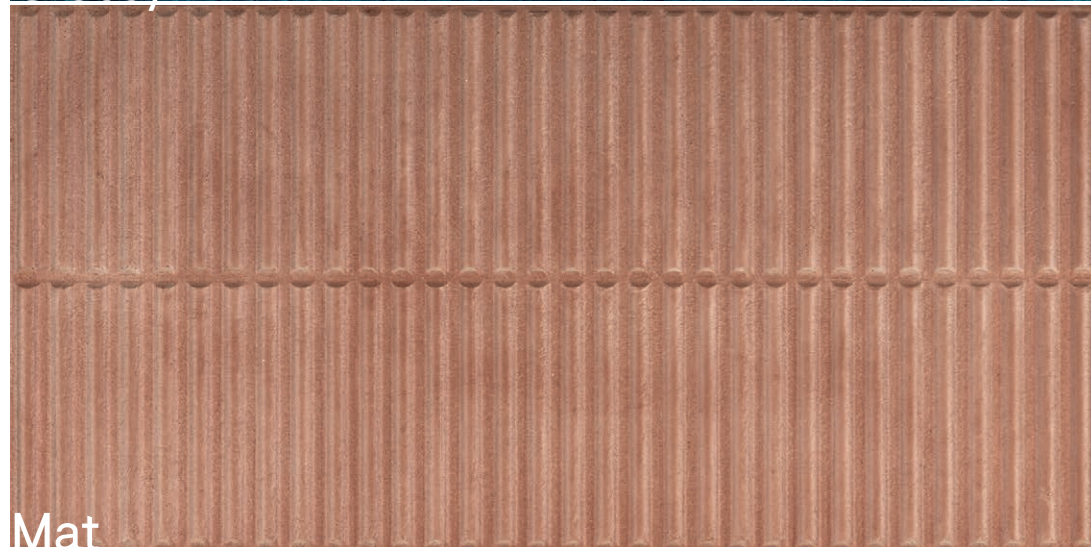

Mat

# Abbinabilità

Matching  
Passende Kombinationen  
Coloris Compatibles



Stripes White Glossy



Taupe

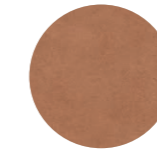

Cotto

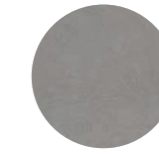

Dove

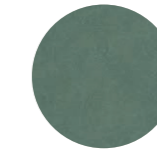

Sage

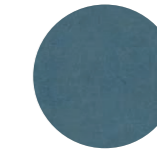

Berry



Stripes Mustard Glossy



Taupe



Dove

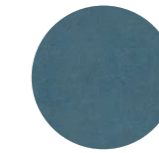

Berry

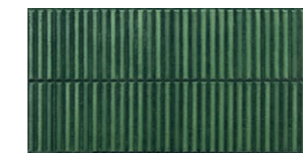

Stripes Green Glossy



Chalk



Taupe

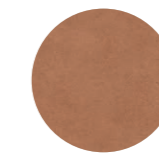

Cotto

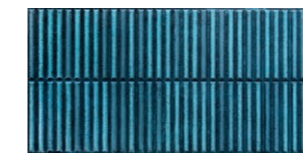

Stripes Blue Glossy



Chalk



Taupe

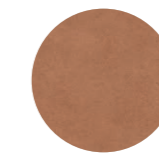

Cotto



Cloudy



Stripes White Mat



Taupe



Cloudy



Dove

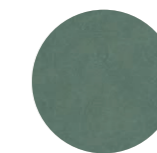

Sage



Berry

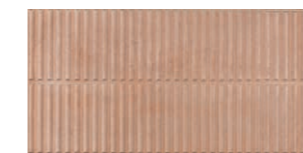

Stripes Powder Mat



Cotto



Berry



Stripes Clay Mat



Chalk



Cotto

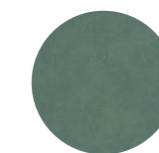

Sage



Berry



Stripes Grey Mat



Chalk



Cloudy

# Riepilogo Gamma

Collection  
Serie  
Gamme

Formati Sizes					DIN 51130	DIN 51097	DCOF	BSEN 7976-2
	120*120 48"×48"	60*120 24"×48"	60*60 24"×24"	10*60 4"×24"				
	± 9	± 9.5	± 9.5	± 9.5				
Nat/Ret Chalk	05245	05216	05224	05277	V2	R10	B	>0.42 P3
Nat/Ret Taupe	05248	05219	05227	05280	V2	R10	B	>0.42 P3
Nat/Ret Cotto	05249	05221	05228	05281	V2	R10	B	>0.42 P3
Nat/Ret Cloudy	05246	05217	05225	05278	V2	R10	B	>0.42 P3
Nat/Ret Dove	05247	05218	05226	05279	V2	R10	B	>0.42 P3
Nat/Ret Sage		05222	05229	05282	V2	R10	B	>0.42 P3
Nat/Ret Berry		05223	05231	05283	V2	R10	B	>0.42 P3

Decori Decors						
	Flower Cotto 60*120 24"×48"	Flower Chalk 60*120 24"×48"	Rammed Warm 60*120 24"×48"	Rammed Cold 60*120 24"×48"	Bloom White 60*120 24"×48"	Bloom Blue 60*120 24"×48"
	± 9.5	± 9.5	± 9.5	± 9.5	± 9.5	± 9.5
		05242	05244	05243	05276	
				05243	05275	
	05241		05244	05243	05276	
				05243	05275	
		05242		05243	05276	
		05242			05276	
	05241					

Structure 3D 3D Structures								
	Stripes White Glossy 30*60 12"×24"	Stripes Mustard Glossy 30*60 12"×24"	Stripes Green Glossy 30*60 12"×24"	Stripes Blu Glossy 30*60 12"×24"	Stripes White Mat 30*60 12"×24"	Stripes Powder Mat 30*60 12"×24"	Stripes Clay Mat 30*60 12"×24"	Stripes Grey Mat 30*60 12"×24"
	± 9.5	± 9.5	± 9.5	± 9.5	± 9.5	± 9.5	± 9.5	± 9.5
Nat/Ret Chalk			05233	05232			05238	05239
Nat/Ret Taupe	05234	05235	05233	05232	05236			
Nat/Ret Cotto	05234		05233	05232		05237	05238	
Nat/Ret Cloudy				05232	05236			05239
Nat/Ret Dove	05234	05235			05236			
Nat/Ret Sage	05234				05236		05238	
Nat/Ret Berry	05234	05235			05236	05237	05238	

Perzi Speciali Special Pieces		
	Gradino Costa Retta 33*120 13"×48"	Battiscopa 4,5*60 1 3/4"×24"
	± 9.5	± 9.5
	05264	05256
	05267	05259
	05268	05261
	05265	05257
	05266	05258
	05269	05262
	05271	05263



# Imballi

Packing  
Verpackung  
Emballage

Formati Sizes		± MM	 Pezzi Scatola Pieces/Box Stck/Karton Carreaux/Boîte	 Mq/Scatola Sqmt/Box Qm/Karton M2/Boîte	 Kg/Scatola Kgs/Box Kg/Karton Kg/Boîte	 Scatole/Paletta Boxes/Pallet Karton/Palette Boîte/Palette	 Mq/Paletta Sqmt/Pallet Qm/Pallet M2/Palette	 Kg/Paletta Kgs/Pallet Kg/Pallet Kg/Palette	 Formato Paletta Size Pallet Format Pallet Dim. Palette
120x120 (48"x48") Nat/Ret	P	9	2	2,880	57,00	22	63,36	1254,00	132x132x53
60x120 (24"x48") Nat/Ret	P	9,5	2	1,440	31,00	30	43,20	930,00	120x80x75
60x60 (24"x24") Nat/Ret	P	9,5	4	1,440	29,00	32	46,08	928,00	120x80x75
10x60 (4"x24") Nat/Ret	P	9,5	10	0,600	12,50	72	43,20	900,00	120x80x75
30x60 (12"x24") Stripes Nat/Ret	P	9,5	7	1,260	26,30	32	40,32	841,60	120x80x75
60x120 (24"x48") Rammed Nat/Ret	P	9,5	2	1,440	31,00	30	43,20	930,00	120x80x75
60x120 (24"x48") Bloom Nat/Ret	P	9,5	2	1,440	31,00	30	43,20	930,00	120x80x75
60x120 (24"x48") Flower Nat/Ret	P	9,5	2	1,440	31,00	30	43,20	930,00	120x80x75

### Pezzi Speciali / Special Pieces

33x120 (13"x48") Gradino Costa Retta Nat/Ret	P	9,5	2	0,792	18,50	20	-	-	-
4,5x60 (1¾"x24") Battiscopa Nat/Ret	P	9,5	14	0,378 m.l. 8,40	8,00	80	-	-	-

Tutti i formati sono nominali.

All sizes are nominal.

Die Formate sind Nennwerte.

Tous les formats sont nominaux.

Gli spessori riportati in questo catalogo sono nominali e possono variare a seconda dei formati e delle finiture.

The thickness mentioned on this catalogue are nominal and can be different according to the sizes and the finishes.

Die in diesem Katalog angegebenen Fliesenstärke sind nominal und können, je nach Format oder Oberfläche, verschieden sein.

Les épaisseurs reportées sur ce catalogue sont nominales et peuvent varier suivant les formats et les finitions.

I colori e le caratteristiche estetiche dei prodotti sono quanto più possibile vicini a quelli reali, nei limiti consentiti dai processi di stampa.

The colours and appearance features of the products are as close as possible to reality, within the limitation of the printing process.

Die Farben und die ästhetischen Eigenschaften der Produkte entsprechen der Wirklichkeit, innerhalb den von dem Druckverfahren erlaubten Grenzen.

Les couleurs et les caractéristiques esthétiques sont fidèles aux couleurs et caractéristiques réelles dans les limites des procédés d'impression.

# Pezzi Speciali

Special pieces  
Formstücke  
Pièces spéciales

Battiscopa Nat/Ret 4,5x60 – 1¾"x24" ± 9,5

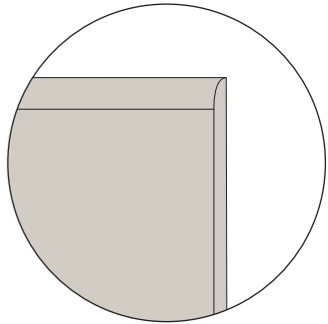
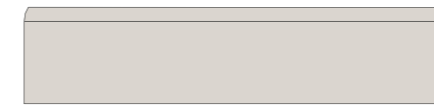

Gradino Costa Retta Nat/Ret 33x120 – 13"x48" ± 9,5  
(costa retta ottenuto per taglio e incollaggio - obtained by cutting and gluing)

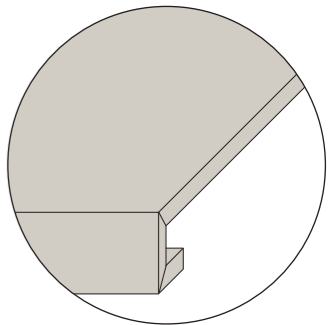
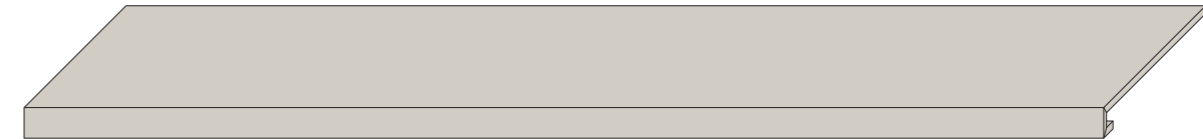

# Norme per la posa e la manutenzione

Installation and maintenance instructions

- Per i prodotti rettificati consigliamo una fuga di 2 mm per un migliore risultato di posa.
- Per una migliore resa estetica Piemme consiglia stuccature colorate in tinta con le piastrelle. Verificare, prima dell'utilizzo, la compatibilità ed idoneità dei riempitivi per fughe con il prodotto ceramico.
- Rimuovere le eccedenze dei riempitivi per fughe quando gli stessi sono ancora freschi.
- Attenersi scrupolosamente alle istruzioni indicate dai produttori dei riempitivi per fughe.
- Per eliminare completamente i residui di posa, che potrebbero compromettere la manutenzione ordinaria e le caratteristiche del prodotto, a posa ultimata, procedere con la pulizia utilizzando prodotti adeguati, a base Acida max 3%, rispettando le indicazioni del produttore. Osservare assolutamente i limiti di tempo indicati nelle istruzioni: un contatto troppo prolungato con questi prodotti potrebbe provocare il danneggiamento della superficie.
- Gli eventuali aloni che si dovessero presentare dopo la posa di materiali lappati o levigati si potranno facilmente eliminare utilizzando un prodotto idoneo, a base Alcalina.
- Riguardo l'utilizzo di materiali ceramici all'esterno, pure riconfermando l'ingelività dei prodotti Piemme in gres porcellanato, in conformità alle vigenti normative europee EN 14411/ISO 13006-ISO 10545.12, occorre attenersi ad alcune fondamentali norme previste per la posa all'esterno, atte a rendere inattaccabili al gelo i predetti pavimenti. Le condizioni più importanti da rispettare sono: le opportune pendenze, le impermeabilizzazioni, i giunti di dilatazione, e l'uso di idonei materiali per la posa.
- Decorazioni realizzate con smalti e metalli preziosi è indispensabile proteggere la superficie durante la posa, non utilizzare assolutamente prodotti abrasivi e/o acidi, ma solo acqua e sapone neutro. Il produttore non risponde di eventuali danni a questi preziosi materiali causati da "sfregamenti" durante la posa in opera. Per nessun motivo saranno accettate contestazioni relative a materiale posato.

TIPO DI SPORCO	INDICAZIONI PER LA PULIZIA
Birra, Caffè, Gelato, Vino Gomma Pneumatico, Grassi vegetali e animali, Inchiostri, Lampostri Olii Meccanici, Residui di scotch Olio di lino, PennarelloResine Smalti, Tintura per capelli	Prodotti a Base Alcalina
Cera protettiva anti-abrasione, Depositi calcarei, Macchie di ruggine	Prodotti a Base Acida
Cera di candela, Residui di scotch	Solventi
Per ulteriori informazioni specifiche consultare l'area tecnica sul sito Piemme: <a href="http://www.ceramichepiemme.it">www.ceramichepiemme.it</a>	

- For better installation results of rectified products, we suggest 2 mm joint.
- For a better aesthetic finish, Piemme recommends using jointing colours that match the tiles.
- Please check, before using, the compatibility and suitability of grouting material with the ceramic tile.
- Clean away the excess of grouting materials while they are still fresh.
- Follow carefully the instructions pointed out by the producers of tile grouting materials.
- To completely eliminate installation residues, which could negatively affect routine maintenance and product characteristics once installation has terminated, proceed to clean using adequate products, with max. 3% Acid base, following the manufacturer's instructions. Always closely abide by the time limits indicated in the instructions: prolonged contact with these products may cause damage to the surface.
- Any rims that appear after installing lapped or polished materials can be easily eliminated using a suitable Alkaline-based product.
- With regard to the use of ceramic materials outdoors, while once more reiterating that Piemme porcelain stoneware products are frost-proof, in compliance with applicable European standards EN 14411/ISO 13006-ISO 10545.12, a number of fundamental procedures must be followed for outdoor installation, suitable for making the aforementioned floors resistant to frost. The most important aspects are: suitable gradients, waterproofing, expansion joints, and the use of suitable installation materials.
- Decorations made with glazes and precious metals It is most important to protect the surface during installation. Never use abrasive and/or acid products, only water and neutral soap. The manufacturer disclaims liability in case of any damage to these precious materials caused by "rubbing" during installation. Under no circumstances will disputes be accepted relating to the installed material.

TYPE OF STAIN	CLEANING SUGGESTIONS
beer, coffee, wine, ice cream vegetable and animal fats, rubber, remains of scotch tape, grease from machines, linseed oil, felt tip pens, paints, inks, hair dye	Alkaline-based detergent
protective anti-abrasion wax, calcareous residuals, rust stains	Acid-based detergent
candle wax, remains of scotch-tape	Solvents

For further specific details please visit the technical area on Piemme website: [www.ceramichepiemme.it](http://www.ceramichepiemme.it)

# Caratteristiche Tecniche

Technical characteristics  
Technische daten  
Caracteristiques techniques

CLASSIFICAZIONE SECONDO NORME EN 14411 B<sub>A</sub> – ISO 13006 - CLASSIFICATION IN ACCORDANCE WITH EN 14411 B<sub>A</sub> – ISO 13006  
KLASSIFIZIERUNG GEMÄSS NORMEN EN 14411 B<sub>A</sub> – ISO 13006 - CLASSIFICATION SELON LES NORMES EN 14411 B<sub>A</sub> – ISO 13006

CARATTERISTICA TECNICA TECHNICAL CHARACTERISTIC TECHNISCHE DATE CARACTÉRISTIQUE TECHNIQUE	NORMA NORM NORM NORME	VALORE PRESCRITTO VALUE REQUIRED NORMVORGABE VALEUR PRESCRIPTE	VALORE MEDIO MEAN VALUE MITTELWERT VALEUR MOYENNE	NORMA NORM NORM NORME	VALORE MEDIO MEAN VALUE MITTELWERT VALEUR MOYENNE
			CERAMICHEPIEMME FLOOR AND MORE		CERAMICHEPIEMME FLOOR AND MORE
LUNGHEZZA E LARGHEZZA LENGHT AND WIDTH / LÄNGE UND BREITE / LONGUEUR ET LARGEUR		±0.6% (±2.00 MM)			
SPESSORE THICKNESS / STÄRKE / ÉPAISSEUR		±5% (±0.5 MM)			
RETTILINEITÀ LATI WARPAGES OF EDGES / GERADHEIT DER KANTEN / RÉCITUDE DES ARÊTES	ISO 10545.2	±0.5% (±15 MM)	CONFORME IN ACCORDANCE ERFÜLLT CONFORME	ASTM C-499 ASTM C-485 ASTM C-502	IN ACCORDANCE
ORTOGONALITÀ WEDGING / RECHTWINKLIGKEIT / ORTHOGONALITÉ		±0.5% (±2.00 MM)			
PLANARITÀ FLATNESS / PLANITÄT / PLANIMÉTRIE		±0.5% (±2.00 MM)			
ASSORBIMENTO % D'ACQUA WATER ABSORPTION WASSERAFNAHME % ABSORPTION D'EAU %	ISO 10545.3	≤ 0.5%	CONFORME IN ACCORDANCE ERFÜLLT CONFORME	ASTM C-373	IN ACCORDANCE
RESISTENZA ALLA FLESSIONE BENDING STRENGTH BIEGEZUGFESTIGKEIT RÉSISTANCE À LA FLEXION	ISO 10545.4	Modulus of rupture (average): R ≥ 35N/mm <sup>2</sup> Breaking strength for thickness ≥ 7.5 mm S > 1500 N	CONFORME IN ACCORDANCE ERFÜLLT CONFORME	ASTM C-648 250 LBS OR GREATER	IN ACCORDANCE
DILATAZIONE TERMICA LINEARE TRA 20° E 100° C LINEAR THERMAL EXPANSION BETWEEN 20° AND 100° C LINEARE WÄRMEAUSSDEHNUNG ZWISCHEN 20° UND 100° C DILATATION THERMIQUE LINÉAIRE ENTRE 20° ET 100° C	ISO 10545.8	SECONDO I DATI DEL COSTRUTTORE ACCORDING TO BUILDER'S SPECIFICATIONS LAUT ANGABEN DES HERSTELLERS SELON LES ELEMENTS DU COSTRUCTEUR	= 7x10 <sup>-6</sup> C <sup>-1</sup>		
RESISTENZA AGLI SBALZI TERMICI THERMAL SHOCK RESISTANCE TEMPERATURWECHSELBESTÄNDIGKEIT RÉSISTANCE AUX ÉCARTS DE TEMPÉRATURE	ISO 10545.9	RICHIESTA REQUEST BITTE DEMANDE	RESISTENTE RESISTANT WIDERSTEHEND RÉSISTANT		
RESISTENZA AL GELO FROST RESISTANCE FROSTBESTÄNDIGKEIT RÉSISTANCE AU GEL	ISO 10545.12	RICHIESTA REQUEST BITTE DEMANDE	RESISTENTE RESISTANT WIDERSTEHEND RÉSISTANT	ASTM C-1026	IN ACCORDANCE
RESISTENZA ALL'ATTACCO CHIMICO RESISTANCE TO CHEMICAL ATTACK BESTÄNDIGKEIT GEGEN CHEMIKALIEN RÉSISTANCE À L'ATTAQUE CHIMIQUE	ISO 10545.13	SECONDO I DATI DEL COSTRUTTORE ACCORDING TO BUILDER'S SPECIFICATIONS LAUT ANGABEN DES HERSTELLERS SELON LES ELEMENTS DU COSTRUCTEUR	RESISTENTE RESISTANT WIDERSTEHEND RÉSISTANT	ASTM C-650	IN ACCORDANCE
RESISTENZA DEI COLORI ALLA LUCE COLOURS RESISTANCE TO LIGHT LICHTBESTÄNDIGKEIT RÉSISTANCE DES COULEURS À LA LUMIÈRE	DIN 51094	NESSUNA ALTERAZIONE NO ALTERATION KEINE VERÄNDERUNG AUCUNE ALTERATION	CONFORME IN ACCORDANCE ERFÜLLT CONFORME		
RESISTENZA ALLE MACCHIE STAIN RESISTANCE FLECKENFESTIGKEIT RÉSISTANCE AUX TACHES	ISO 10545.14	> CLASSE 3 METODO DI PROVA DISPONIBILE TEST METHOD AVAILABLE VERFÜGBARE PRÜFMETHODE METHODE D'ESSAI DISPONIBILE	CONFORME IN ACCORDANCE ERFÜLLT CONFORME		
			NAT	R10	NAT
	DIN 51130 *	9 ≤ R ≤ 13		ASTM C-1028 * COF ≥ 0.6 DRY ≥ 0.6 WET	
RESISTENZA ALLO SCIVOLAMENTO SLIPPAGE RESISTANCE RUTSCHSICHERHEIT RÉSISTANCE AU GLISSEMENT			NAT	B	NAT
	DIN 51097 *	A,B,C		ANSI * 137.1-2012 DCOF > 0.42 WET	> 0.42
			NAT	Wet, Dry > 36	NAT
PENDULUM SLIP TEST	BS EN 7976-2*	> 36 DRY > 36 WET		AS 4586: 2013 CLASS	P3

\*TRATTANDOSI DI NORMATIVE NAZIONALI, I METODI DI PROVA, I REQUISITI E LE CLASSIFICAZIONI VARIANO DA PAESE A PAESE. IL VALORE ATTESO DALLA RESISTENZA ALLO SCIVOLAMENTO DELLA PRODUZIONE DI INDUSTRIE CERAMICHE PIEMME S.P.A., PUÒ VARIARE IN BASE AL LOTTO PRODUTTIVO. SPECIFICA DOCUMENTAZIONE È DISPONIBILE SU RICHIESTA.  
TEST METHODS, REQUIREMENTS AND CLASSIFICATIONS DIFFER FROM COUNTRY TO COUNTRY, ACCORDING TO THE NATIONAL REGULATIONS. THE EXPECTED VALUE OF SLIPPAGE RESISTANCE OF PRODUCTS BY INDUSTRIE CERAMICHE PIEMME S.P.A. MAY VARY DEPENDING ON THE PRODUCTION BATCH. SPECIFIC DOCUMENTS ARE AVAILABLE UPON REQUEST.  
PRÜFVERFAHREN, ERFORDERNISSE UND KLASSIFIKATIONEN SIND VERSCHIEDEN VON LAND ZU LAND, GEMÄSS DER NATIONALEN VORSCHRIFTEN. DER ERWARTUNGSWERT DER RUTSCHSICHERHEIT DER PRODUKTE VON INDUSTRIE CERAMICHE PIEMME S.P.A. KANN SICH - JE NACH DER PRODUKTIONSPARTIE - VERÄNDERN. SPEZIFISCHE UNTERLAGEN SIND AUF VERLANGEN ZUR VERFÜGUNG.  
LES MÉTHODES D'ESSAI, LES RÉQUISITIONS ET LES CLASSIFICATIONS CHANGENT DE PAYS À PAYS, SELON LES RÉGLEMENTATIONS NATIONALES. LA VALEUR ATTENDUE DE RÉSISTANCE AU GLISSEMENT DES PRODUITS DE INDUSTRIE CERAMICHE PIEMME S.P.A. PEUT VARIER EN FONCTION DU LOT DE PRODUCTION. UNE DOCUMENTATION SPÉCIFIQUE EST DISPONIBLE SUR DEMANDE.

ELENCO DELLE SERIE CERTIFICATE E CLASSIFICAZIONI DISPONIBILI A RICHIESTA - LIST OF CERTIFIED SERIES AND CLASSIFICATIONS AVAILABLE UPON REQUEST  
LISTE DER GEPRÜFTEN SERIE UND KLASSIFIZIERUNGEN AUF ANFRAGE ERHÄLTICH - LISTE DES SERIES CERTIFIÉES ET DES CLASSEMENTS DISPONIBLES SUR DEMANDE



CERAMICHEPIEMME  
FLOOR AND MORE



Project Management  
Mktg Piemme

#### Una storia tutta italiana

Piemme dal 1962, anno della sua fondazione, è protagonista indiscussa del vero Made in Italy, quello fatto di eccellenza, passione e creatività. Oggi tutti i materiali Piemme sono prodotti con tecnologia d'avanguardia come la decorazione digitale inkjet HD, la cottura in forni ad energia pulita a recupero di calore, la rettifica e levigatura in linea "one roof" e la verifica elettronica dello standard qualitativo.

#### An all-Italian story

Since 1962, the year of its foundation, Piemme has been the undisputed protagonist of real Made in Italy, that which consists of excellence, passion and creativity. Today, all Piemme materials are made using cuttingedge technology such as HD inkjet digital decoration, firing in heat-recycling cleanenergy kilns, "one roof" grinding and polishing line and electronic quality standard control.

#### Eine ganz italienische Geschichte

Seit dem Gründungsjahr 1962 ist Piemme ein unangefochtener Hauptakteur des echten Made in Italy: jenem, das auf Exzellenz, Leidenschaft und Kreativität gründet. Alle Piemme Erzeugnisse werden heute unter Einsatz von Spitzentechnologie produziert, wie zum Beispiel mit der digitalen Inkjet-Dekoration, dem Brennen in Öfen mit grüner Energie und Wärmerückgewinnung, dem Schleifen und Polieren in der Linie „unter einem Dach“ sowie der elektronischen Prüfung des Qualitätsniveaus.

#### Une histoire toute italienne

Depuis 1962, l'année de sa fondation, Piemme est la protagoniste indiscutée du Made in Italy, basé sur l'excellence, la passion et la créativité. Aujourd'hui toutes les phases du cycle de fabrication Piemme sont issues d'une technologie à l'avant-garde comme la décoration numérique inkjet HD, la cuisson dans des fours à énergie propre et à récupération de chaleur, la rectification et le polissage en en ligne "one roof" et la vérification électronique de la qualité.

# CERAMICHE PIEMME

FLOOR AND MORE

INDUSTRIE CERAMICHE PIEMME S.P.A.  
VIA DEL CROCIALE 42/44, 41042 FIORANO (MO) - ITALY  
T. +39 0536.849111 - F. +39 0536.849402  
WWW.CERAMICHEPIEMME.IT - INFO@CERAMICHEPIEMME.IT