



Grès Fine Porcellanato Rettificato Monocalibro
Fine Porcelain Stoneware Rectified Monocaliber

TRUST



atlas concorde



MADE IN ITALY
Espressione di stile, qualità, etica
Expression of style, quality, ethics
Expression de style, qualité, éthique
Der Ausdruck des Stiles, der Qualität und Ethik
Expresión de estilo, calidad, ética
Воплощение стиля, качества, этики



TECHNICAL PORCELAIN STONEWARE - GRES PORCELLANATO TECNICO
GRÈS CÉRAME TECHNIQUE - TECHNISCHES FEINSTEINZEUG
GRES PORCELÁNICO TÉCNICO - ТЕХНИЧЕСКИЙ КЕРАМИЧЕСКИЙ ГРАНИТ

01 MATERIAL
. materia



02 NATURALNESS
. naturalezza



03 ATMOSPHERE
. atmosfera



04 PROJECT
. progetto



05 COLOUR
. colore



06 STRENGTH
. vigore



TRUST

NATURE BECOMES A DESIGN PROJECT la natura diventa progetto

An untamed and captivating nature is the source of inspiration for a ceramic collection evoking natural stone, its surfaces, its richness of details. Nature extends into space creating enveloping and alluring atmospheres.

Una natura rigogliosa e affascinante diventa ispirazione del progetto ceramico con una collezione che richiama la pietra, la sua matericità, la sua ricchezza di dettagli. La natura invade lo spazio creando atmosfere avvolgenti e suggestive.

La nature se fait projet. Une nature luxuriante et fascinante sert d'inspiration à un projet céramique dans cette collection qui rappelle la pierre, sa matière et sa richesse en détails. La nature envahit l'espace et compose des atmosphères enveloppantes et suggestives.

La naturaleza se convierte en proyecto. Una naturaleza lozana y fascinante se transforma en inspiración del proyecto cerámico con una colección que recuerda la piedra, su cualidad material, su riqueza de detalles. La naturaleza invade el espacio creando atmósferas acogedoras y sugerentes.

Natur wird zum Projekt. Üppige und bezaubernde Natur inspiriert die Kollektion eines keramischen Projektes, das den Stein an sich, seine Materialität und seinen Detailreichtum aufgreift. Natur besetzt den Raum und schafft neue behagliche und stimmungsvolle Atmosphären.

Природа становится проектом. Роскошная и чарующая природа стала источником вдохновения коллекции керамической плитки, напоминающей камень, его вещественность, его богатство деталями. Природа захватывает пространство, рождая притягательную, волнующую атмосферу.



01. INDOOR_SHOWROOM trust titanium

TRUST TITANIUM 60X60 / 24"X24"
TRUST TITANIUM BRICK 30X60 / 12"X24"

MATERIAL materia

The strong material look of Trust recalls quartzite and Luserna stones, with a surface characterized by intense chromatic and texture veinings, obtained using the most advanced and cutting-edge ceramic technologies.

L'aspetto fortemente materico di Trust richiama le quarziti e le Pietre di Luserna con una superficie dalle intense variegature cromatiche e strutturali, ottenute mediante l'utilizzo delle più moderne e sofisticate tecnologie ceramiche.

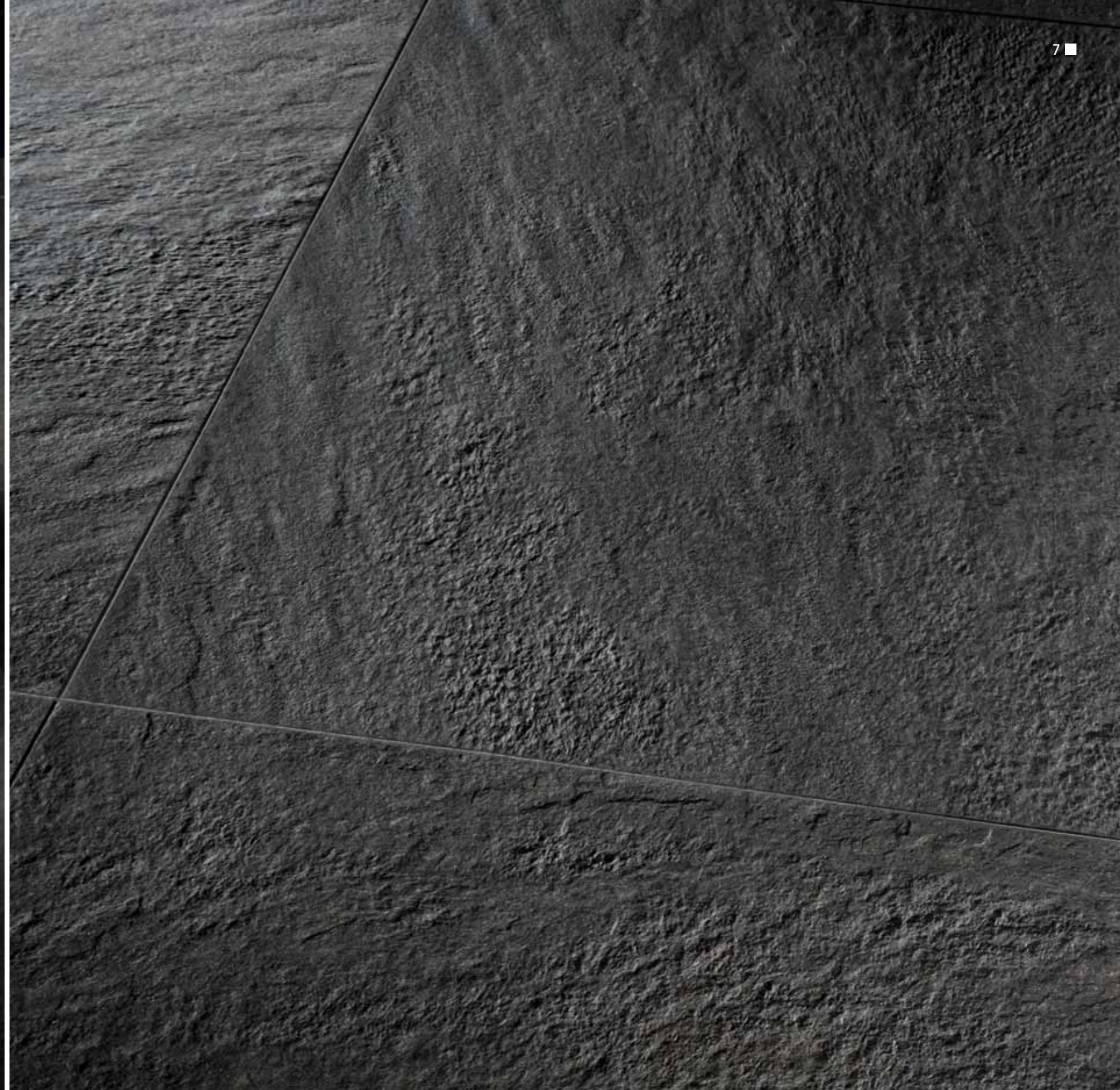

matière MATERIE materia МАТЕРИЯ

TRUST TITANIUM 60X60 / 24"X24"

En Trust, l'aspect marqué de matière rappelle les quartzites et les Pierres de Luzerne avec une surface aux marbrures chromatiques et structurelles intenses qui sont obtenues par l'utilisation des technologies céramiques les plus modernes et sophistiquées.

Das starke materische Aussehen von Trust erinnert mit einer Oberfläche, auf der sich intensive Farben und Strukturen abwechseln, die man durch ausgefeilte moderne keramische Technologien erhält, an Quarz und Luserna Steine.

El aspecto decididamente material de Trust recuerda las cuarcitas y las piedras de Luserna con una superficie de intensas variegaciones cromáticas y estructurales, obtenidas mediante el uso de las más modernas y sofisticadas tecnologías cerámica

Своим основательным видом Trust напоминает кварциты и гнейсы пьемонтских Предалль (Pietra di Luserna); поверхность коллекции отличается насыщенным цветовым и структурным разнообразием, получаемым благодаря использованию самых современных производственных технологий.

INDOOR_SHOWROOM
trust titanium



TRUST TITANIUM 60X60 / 24"X24"



TRUST TITANIUM BRICK 30X60 / 12"X24"



02. OUTDOOR/INDOOR_HALL trust copper

TRUST COPPER 20X60 / 8"X24" - 30X60 / 12"X24"
40X60 / 16"X24" - 60X60 / 24"X24"

NATURALNESS naturalness

The broad range of available sizes allows for many different installation patterns to express the natural variability of the surface to the utmost. The technical features meet creative freedom and aesthetical personalisation.

L'ampia gamma di formati consente una molteplicità di pose per esprimere alla massima potenza la naturale variabilità della superficie. Le qualità tecniche incontrano così libertà creativa e personalizzazione estetica.



naturalité NATÜRLICHKEIT naturalidad НАТУРАЛЬНОСТЬ

TRUST COPPER 20X60 / 8"X24" - 30X60 / 12"X24" - 40X60 / 16"X24"

La vaste gamme de formats permet de nombreuses mises en place, qui permettent d'exprimer au mieux toute la variabilité naturelle de la surface. Les qualités techniques rencontrent ainsi la liberté créative et la personnalisation esthétique.

Das breite Formatsortiment sorgt für vielfältige Verlegungsmöglichkeiten, um die maximale Kraft der natürlichen Oberflächenveränderlichkeit auszudrücken. Technische Qualität trifft so auf kreative Freiheit und individuelle Ästhetik.

La amplia gama de formatos permite una multiplicidad de colocaciones para expresar a la máxima potencia la natural variabilidad de la superficie. De esta manera las características técnicas se unen a la libertad creativa y a la personalización estética.

Широкая гамма форматов открывает возможность для самых многообразных вариантов укладки, максимально подчёркивающих натуральную пестроту поверхности. Технические качества, таким образом, сопрягаются с творческой свободой и эстетической индивидуализацией.

OUTDOOR/INDOOR_HALL
trust copper

TRUST COPPER 60X60 / 24"X24"



TRUST COPPER 20X60 / 8"X24"





03 INDOOR_LIVING ROOM trust silver

TRUST SILVER 30X60 / 12"X24"
TRUST SILVER MOSAICO 30X30 / 12"X12"

ATMOSPHERE atmosfera

Trust is a design surface for contemporary architectures, that brings evocative and natural atmospheres to everyday living spaces. The Mosaico and Brick tesserae decorations multiply the surface colour shading, giving the impression of countless small pieces.

Trust è una superficie di arredo per architetture contemporanee che porta negli spazi quotidiani suggestive atmosfere naturali. Le decorazioni in tessere del Mosaico e del Brick moltiplicano la variegatura superficiale in tanti piccoli tasselli.



atmosphère ATMOSPHERE atmósfera ATMOCΦERA

TRUST SILVER 30X60 / 12"X24"

Trust est une surface de décoration destinée aux architectures contemporaines qui apporte de suggestives atmosphères naturelles aux espaces de tous les jours. Les décorations mosaïques de Mosaico et de Brick multiplient la marbrure de surfaces en de nombreuses petites tesselles.

Trust ist eine Einrichtungsfläche für zeitgenössische Architektur, die in Alltagsräumen natürliche, bezaubernde Atmosphären schafft. Die Dekorsteine des Mosaiks und von Brick zerteilen die Sprenkel auf der Oberfläche in viele kleine Bestandteile.

Trust es una superficie de decoración para arquitecturas contemporáneas que brinda a los espacios cotidianos sugerentes atmósferas naturales. Las decoraciones en teselas del Mosaico y del Brick multiplican la variegación superficial en un sinfín de pequeñas piezas.

Trust – это поверхность для оформления современных архитектурных форм, привносящая в интерьеры чарующую натуральную атмосферу. Декоры Mosaico и Brick множеством своих маленьких элементов усиливают пёструю расцветку поверхности.

INDOOR LIVING ROOM
trust silver



TRUST SILVER 30X60 / 12"X24" - TRUST SILVER MOSAICO 30X30 / 12"X12"



TRUST SILVER 30X60 / 12"X24"



04. INDOOR/OUTDOOR_VILLA trust ivory&gold

TRUST IVORY 45X90 / 18"X36"
 TRUST GOLD 22,5X90 / 9"X36"
 TRUST IVORY BRICK 30X60 / 12"X24"
 TRUST GOLD 60X60 / 24"X24" LASTRA 20mm

PROJECT progetto

Trust increases its planning and application potential thanks to the large sizes, 45x90 and 22.5x90, able to exalt the richness of the surface and create impeccable compositions in large spaces. The listels of the Brick decor finish the project giving walls a sense of dynamism.

Trust aumenta le proprie potenzialità progettuali e applicative con i grandi formati 45x90 e 22,5x90, capaci di esaltare la ricchezza materica della superficie e creare composizioni impeccabili negli spazi ampi. I listelli del decoro Brick rifiniscono il progetto conferendo movimento alle pareti.



projet PROJEKT proyecto ПРОЕКТ

TRUST IVORY 45X90 / 18"X36"

Trust élargit son potentiel en proposant de nouvelles solutions de conception et d'application avec les grands formats 45x90 et 22,5x90, capables de mettre en valeur la richesse de la matière et de la surface, et de créer des compositions impeccables dans les grands espaces. Les listels Brick peaufinent les finitions du projet en donnant du mouvement aux murs.

Mit den Großformaten 45x90 und 22,5x90 steigert Trust die Möglichkeiten der Gestaltung und der Anwendung, betont dadurch den materiellen Reichtum der Oberfläche und schafft makellose Kompositionen in großen Räumen. Die Leisten des Dekor Brick runden das Projekt ab, indem sie den Wänden Bewegung verleihen.

Trust aumenta sus potencialidades aplicativas y de diseño con los grandes formatos 45x90 y 22,5x90, capaces de realzar la riqueza material de la superficie y crear composiciones impecables en los espacios amplios. Los listeles de la decoración Brick acaban el proyecto donando movimiento a las paredes.

Оформительский потенциал коллекции Trust значительно расширяется благодаря большим форматам 45x90 и 2,5x90, которые подчёркивают богатство фактуры и стильно украшают крупные проекты. Бордюры Brick придают стенам восхитительный динамизм.

INDOOR/OUTDOOR_VILLA
trust ivory&gold



LASTRA 20CE

TRUST GOLD 60X60 / 24"X24" LASTRA 20mm

Trust is the first collection by Atlas Concorde available in the Lastra 20mm version, single-piece ceramic slabs of 20 mm thickness for an exclusive use in outdoor applications. Thanks to the anti-slip R11 A+B+C features, Lastra 20mm ensures resistance and safety in any outdoor venue.

Trust è la prima collezione che Atlas Concorde propone nella versione Lastra 20mm, pezzi ceramici monolitici di 20 mm di spessore per un esclusivo utilizzo in esterno. Grazie alle caratteristiche antiscivolo R11 A+B+C, Lastra 20mm assicura resistenza e sicurezza in qualsiasi pavimentazione esterna.



Trust est la première collection qu'Atlas Concorde propose dans la version Lastra 20mm : des pièces céramiques monolithiques de 20 mm d'épaisseur pour une utilisation exclusive en extérieur. Grâce aux propriétés antidérapantes classées R11 A+B+C, Lastra 20mm assure résistance et sécurité pour tous les revêtements de sols extérieurs.

Trust ist die erste Kollektion von Atlas Concorde, die in der Version Lastra 20mm, den monolithischen Keramikplatten von 20 mm Stärke, angeboten wird und sich für einen exklusiven Einsatz in Außenbereichen eignet. Dank der rutschhemmenden Eigenschaften R11 A + B + C sorgt Lastra 20mm für Langlebigkeit und Sicherheit eines jeden Bodens im Freien.

Trust es la primera colección que Atlas Concorde propone en la versión Lastra 20mm, piezas cerámicas monolíticas de 20 mm de espesor para un exclusivo empleo en exteriores. Gracias a las características antideslizamiento R11 A+B+C, Lastra 20mm garantiza resistencia y seguridad para cualquier pavimento exterior.

Trust – это первая коллекция, которую Atlas Concorde предлагает в варианте Lastra 20mm. Её монолитные плитки толщиной в 20 мм предназначены для наружного применения. Благодаря высокому коэффициенту сопротивления скольжению (R11 A+B+C) Lastra 20mm обеспечивает высокую стойкость и безопасность уличных покрытий.



05 OUTDOOR_CAFÉ
.trust gold

TRUST GOLD 30X30 / 12"X12"

COLOUR **colore**

The perfect synthesis between aesthetics and technology, Trust finds its perfect application in residential and commercial spaces, both indoors and outdoors. The five colours are inspired by the hues of the most precious quarry stones, creating a refined chromatic effect on the surface.

Perfetta sintesi di estetica e tecnologia, Trust trova applicazione negli spazi residenziali e commerciali, all'interno come all'esterno. I cinque colori traggono ispirazione dalle tonalità delle più pregiate pietre da spacco, racchiudendo in sé un raffinato movimento cromatico.



couleur FARBE color ЦВЕТ

TRUST GOLD 30X30 / 12"X12"

Synthèse parfaite entre l'esthétique et la technologie, Trust trouve son application tant à l'intérieur qu'à l'extérieur des espaces résidentiels et commerciaux. Les cinq couleurs s'inspirent des tons des plus précieuses pierres de taille qui renferment en elles un mouvement chromatique raffiné.

Perfekte Synthese von Ästhetik und Technologie, Trust für eine Verwendung in Wohn- und Geschäftsbereichen, Innen und Außen. Die fünf Farben, inspiriert durch die Farbgebungen der kostbarsten Steine, weisen raffinierte Farbbewegungen auf.



Perfecta síntesis de estética y tecnología, Trust es adecuado para espacios residenciales y comerciales, tanto en interiores como en exteriores. Los cinco colores se inspiran en las tonalidades de las piedras de corte más valiosas, encerrando dentro de sí un refinado movimiento cromático.

Совершенный синтез эстетики и технологии, Trust находит применение в жилых и общественных контекстах, в интерьерах и экстерьерах. Пять тонов навеяны колоритом ценнейших горных пород и заключают в себе утончённый цветовой динамизм.



STRENGTH vigore

The excellent technical characteristics of the collection also allow for high-tech results in outdoor spaces. The Grip finish in the 30x60 size increases the collection potential for top performance applications (R12).

Le altissime qualità tecniche della collezione consentono risultati sicuri anche negli spazi esterni. La finitura Grip nel formato 30x60 aumenta le potenzialità della collezione per applicazioni ad elevate prestazioni (R12).

vigueur LEISTUNG vigor СИЛА

Les très hautes qualités techniques de la collection permettent d'obtenir un résultat certain même à l'extérieur. La finition Grip en format 30x60 augmentent les potentialités de la collection pour des applications aux performances élevées (R12).

Die hochwertige technische Qualität der Kollektion ermöglicht die Verwendung auch in Außenbereichen. Das Finish Grip im Format 30x60 erweitert die Anwendungsmöglichkeiten der Kollektion für den Einsatz wo hohen Leistungen gefordert sind (R12).

Las altísimas cualidades técnicas de la colección permiten resultados seguros incluso en los espacios exteriores. La terminación Grip en el formato 30x60 aumenta las potencialidades de la colección para aplicaciones de elevadas prestaciones (R12).

Высочайшие технические качества плиток обеспечивают надёжный результат и в случае их укладки в экстерьерах. Шероховатая отделка формата 30x60 увеличивает функциональный потенциал коллекции, делая её пригодной для высоких эксплуатационных нагрузок (R12).

TRUST

TITANIUM v3

Rectified / **Rettificato**
 45x90 cm / 18"x36" 10 mm
 22,5x90 cm / 9"x36" 10 mm
 60x60 cm / 24"x24" 10 mm
 40x60 cm / 16"x24" 10 mm

Rectified / **Rettificato**
 30x60 cm / 12"x24" 10 mm
 20x60 cm / 8"x24" 10 mm
 30x30 cm / 12"x12" 9,5 mm

Non-rectified / **Non rettificato**
 15x15 cm / 6"x6" 10 mm

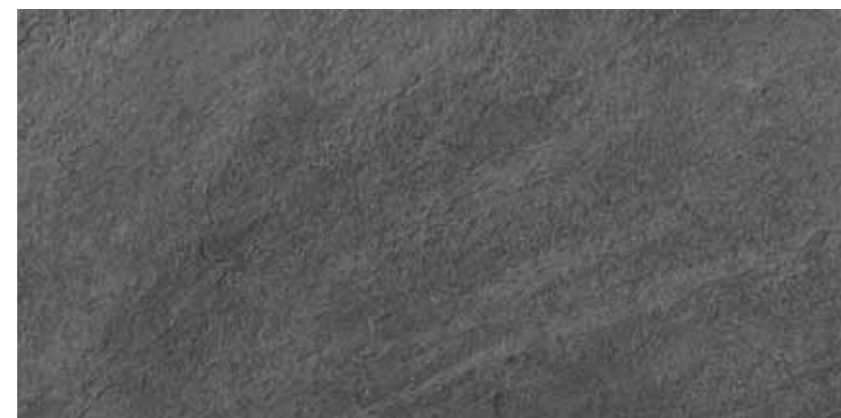

Trust Titanium - 45x90 cm / 18"x36"

Trust Titanium - 60x60 cm / 24"x24" 



Trust Titanium - 22,5x90 cm / 9"x36"



Trust Titanium - 40x60 cm / 16"x24" 



Trust Titanium 30
 30x30 cm / 12"x12" 



Trust Titanium - 30x60 cm / 12"x24"
 Trust Titanium Grip - 30x60 cm / 12"x24" 



Trust Titanium 15x15
 15x15 cm / 6"x6"



Trust Titanium - 20x60 cm / 8"x24" 

GREEN PROJECT - LEED

 Manufactured with minimum 40% of pre-consumer recycled materials, it can contribute to the awarding of 2 LEED credits. Contiene oltre il 40% di materiale riciclato pre-consumer e può contribuire al raggiungimento di 2 crediti LEED. Contient plus de 40% de matière recyclée pré-consumer et il peut contribuer à obtenir 2 crédits LEED. Enthält 40% pre-consumer Recyclingmaterial welches zur Erreichung von 2 LEED Punkten beitragen kann. Contiene más de un 40% de materiales reciclados pre-consumer y puede contribuir al conseguimiento de 2 puntos LEED. Содержит не менее 40% рециклированного до потребления материала что может способствовать накоплению баллов по стандарту LEED.

TECHNICAL PORCELAIN STONWARE - RECTIFIED MONOCALIBER
GRES PORCELLANATO TECNICO - RETTIFICATO MONOCALIBRO
 GRÈS CÉRAME TECHNIQUE - RECTIFIÉ MONO-CALIBRE
 TECHNISCHES FEINSTEINZEUG - GESCHLIFFEN EINKALIBRIG
 GRES PORCELÁNICO TÉCNICO - RECTIFICADO MONOCALIBRE
 ТЕХНИЧЕСКИЙ КЕРАМИЧЕСКИЙ ГРАНИТ - РЕТИФИЦИРОВАННЫЙ В ОДНОМ КАЛИБРЕ

SLIGHTLY TEXTURED / GRIP
LIEVEMENTE STRUTTURATO / GRIP
 LÉGÈREMENT STRUCTURÉ / GRIP
 LEICHT STRUKTURIERT / GRIP
 LEVEMENTE ESTRUTTURADO / GRIP
 СЛЕГКА СТРУКТУРНАЯ / GRIP



SILVER v3



Trust Silver - 45x90 cm / 18"x36"

Trust Silver - 60x60 cm / 24"x24" 



Trust Silver - 22,5x90 cm / 9"x36"



Trust Silver - 40x60 cm / 16"x24" 



Trust Silver 30
 30x30 cm / 12"x12" 



Trust Silver - 30x60 cm / 12"x24"
 Trust Silver Grip - 30x60 cm / 12"x24" 



Trust Silver 15x15
 15x15 cm / 6"x6"



Trust Silver - 20x60 cm / 8"x24" 

GREEN PROJECT - LEED

 Manufactured with minimum 20% of pre-consumer recycled materials, it can contribute to the awarding of 1 LEED credit. Contiene oltre il 20% di materiale riciclato pre-consumer e può contribuire al raggiungimento di 1 credito LEED. Contient plus de 20% de matière recyclée pré-consumer et il peut contribuer à obtenir 1 crédit LEED. Enthält 20% pre-consumer Recyclingmaterial welches zur Erreichung von 1 LEED Punkten beitragen kann. Contiene más de un 20% de materiales reciclados pre-consumer y puede contribuir al conseguimiento de 1 punto LEED. Содержит не менее 20% рециклированного до потребления материала что может способствовать накоплению 1 балла по стандарту LEED.

TRUST

COPPER v3



Trust Copper - 60x60 cm / 24"x24"



Trust Copper - 40x60 cm / 16"x24"



Trust Copper - 30x60 cm / 12"x24"
Trust Copper Grip - 30x60 cm / 12"x24"



Trust Copper - 20x60 cm / 8"x24"



Trust Copper - 45x90 cm / 18"x36"



Trust Copper - 22,5x90 cm / 9"x36"

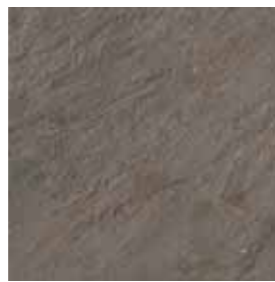

Trust Copper 30
30x30 cm / 12"x12"



Trust Copper 15x15
15x15 cm / 6"x6"

GREEN PROJECT - LEED

Manufactured with minimum 40% of pre-consumer recycled materials, it can contribute to the awarding of 2 LEED credits.
Contiene oltre il 40% di materiale riciclato pre-consumer e può contribuire al raggiungimento di 2 crediti LEED.
Contient plus de 40% de matière recyclée pré-consumer et il peut contribuer à obtenir 2 crédits LEED.
Enthält 40% pre-konsumer Recyclingmaterial welches zur Erreichung von 2 LEED Punkten beitragen kann.
Contiene más de un 40% de materiales reciclados pre-consumer y puede contribuir al conseguimiento de 2 puntos LEED.
Содержит не менее 40% рециклированного до потребления материала что может способствовать накоплению баллов по стандарту LEED.



GOLD v3



Trust Gold - 60x60 cm / 24"x24"



Trust Gold - 40x60 cm / 16"x24"



Trust Gold - 30x60 cm / 12"x24"
Trust Gold Grip - 30x60 cm / 12"x24"



Trust Gold - 20x60 cm / 8"x24"



Trust Gold - 45x90 cm / 18"x36"



Trust Gold - 22,5x90 cm / 9"x36"



Trust Gold 30
30x30 cm / 12"x12"



Trust Gold 15x15
15x15 cm / 6"x6"

TRUST

IVORY v3



Trust Ivory - 60x60 cm / 24"x24"



Trust Ivory - 40x60 cm / 16"x24"



Trust Ivory - 30x60 cm / 12"x24"
Trust Ivory Grip - 30x60 cm / 12"x24"



Trust Ivory - 20x60 cm / 8"x24"



Trust Ivory - 45x90 cm / 18"x36"



Trust Ivory - 22,5x90 cm / 9"x36"



Trust Ivory 30
30x30 cm / 12"x12"



Trust Ivory 15x15
15x15 cm / 6"x6"

DECORS . Decori



Trust Titanium Mosaico
30x30 / 12"x12"



Trust Titanium Brick - 30x60 / 12"x24"



Trust Gold Mosaico
30x30 / 12"x12"



Trust Gold Brick - 30x60 / 12"x24"



Trust Silver Mosaico
30x30 / 12"x12"



Trust Silver Brick - 30x60 / 12"x24"



Trust Ivory Mosaico
30x30 / 12"x12"



Trust Ivory Brick - 30x60 / 12"x24"



Trust Copper Mosaico
30x30 / 12"x12"



Trust Copper Brick - 30x60 / 12"x24"

UPEC CLASSIFICATION SYSTEM . Classificazione UPEC . CLASSIFICATION UPEC

Colour / Colore / Couleur Farbe / Color / Цвет	Size / Formato / Format Format / Formato / Размер	Surface / Superficie / Surface Oberfläche / Superficie / Поверхность	
Ivory, Silver, Copper, Titanium	60x60 - 30x30	Slightly textured Lievemente strutturato Légèrement structuré	U4 P4 E3 C2
	20x60 - 40x60 - 30x60		U4 P3 E3 C2
Gold	60x60 - 30x60 - 20x60 40x60 - 30x30		U3 P3 E3 C2
Ivory, Silver, Copper, Gold, Titanium	30x60	Grip	U4 P3 E3 C2

Per i dettagli sulla Classificazione UPEC: www.atlasconcorde.it/nf-upec.php / Pour avoir plus de détails sur le classement UPEC consultez : www.atlasconcorde.it/nf-upec.php



Trust Titanium - 30x30 / 12"x12"



Trust Silver - 30x30 / 12"x12"



Trust Gold
30x30 / 12"x12"



Trust Ivory - 30x30 / 12"x12"



Trust Copper - 30x30 / 12"x12"



GREEN PROJECT - LEED



Manufactured with minimum 20% of pre-consumer recycled materials, it can contribute to the awarding of 1 LEED credit.
 Contiene oltre il 20% di materiale riciclato pre-consumer e può contribuire al raggiungimento di 1 credito LEED.
 Contient plus de 20% de matière recyclée pre-consumer et il peut contribuer à obtenir 1 crédit LEED.
 Enthält 20% pre-consumer Recyclingmaterial welches zur Erreichung von 1 LEED Punkten beitragen kann.
 Contiene más de un 20% de materiales reciclados pre-consumer y puede contribuir al conseguimento de 1 punto LEED.
 Содержит не менее 20% рециклированного до потребления материала что может способствовать накоплению 1 балла по стандарту LEED.



Manufactured with minimum 40% of pre-consumer recycled materials, it can contribute to the awarding of 2 LEED credits.
 Contiene oltre il 40% di materiale riciclato pre-consumer e può contribuire al raggiungimento di 2 crediti LEED.
 Contient plus de 40% de matière recyclée pre-consumer et il peut contribuer à obtenir 2 crédits LEED.
 Enthält 40% pre-consumer Recyclingmaterial welches zur Erreichung von 2 LEED Punkten beitragen kann.
 Contiene más de un 40% de materiales reciclados pre-consumer y puede contribuir al conseguimento de 2 puntos LEED.
 Содержит не менее 40% рециклированного до потребления материала что может способствовать накоплению баллов по стандарту LEED.



V3

The products of the Trust collection are characterized by a high or moderate chromatic and surface variation.

Tutti i prodotti della collezione Trust si caratterizzano per una variazione cromatica e superficiale da moderata ad alta.

Tous les produits de la collection Trust sont caractérisés par des variations de couleur et de surface allant de hautes à modérées. / Alle Produkte der Kollektion Trust zeichnen sich durch eine Veränderung der Farbe und der Oberfläche von kräftig bis mittel aus. / Todos los productos de la colección se caracterizan por una variación cromática y de superficie alta o moderada. / Все изделия коллекции Trust отличаются поверхностной цветовой неоднородностью: от умеренной до высокой.



V1
 Leggera
 Light
 Léger
 Leichte
 Ligera
 Лёгкое



V2
 Moderata
 Moderate
 Moyen
 Mittlere
 Moderada
 Умеренное



V3
 Alta
 High
 Haut
 Kräftigere
 Alta
 Высокое



V4
 Random
 Random
 Casuel
 Zufällige
 Random
 Произвольное

TRUST

LAISTRA 20mm is the new product range by Atlas Concorde created for outdoor applications. Manufactured in single-piece technical porcelain stoneware slabs of 20 mm thickness, rectified and single work-size, it ensures the maximum resistance and safety in any outdoor venue, thanks to the textured R11 A+B+C surface finish.

LAISTRA 20mm è la nuova gamma di prodotti Atlas Concorde destinata ad applicazioni esterne. Realizzata con la tecnologia del gres porcellanato tecnico rettificato monocalibro in pezzi ceramici monolitici di 20 mm di spessore, assicura resistenza e sicurezza in qualsiasi pavimentazione esterna, grazie alla finitura superficiale strutturata R11 A+B+C.

LAISTRA 20mm est la nouvelle gamme de produits Atlas Concorde destinée à des applications en extérieur. Réalisée avec la technologie du grès cérame technique rectifié monocalibre dans des pièces céramiques monolithiques de 20 mm d'épaisseur, elle assure résistance et sécurité pour tous les revêtements extérieurs grâce à sa finition superficielle structurée R11 A+B+C.

LAISTRA 20mm ist die neue Serie im Produktsortiment von Atlas Concorde, die für die Verwendung in Außenbereichen konzipiert wurde. Hergestellt mit ausgefeilter Technologie für technisches, rektifiziertes und monokalibriertes Feinsteinzeug in monolithischen Keramikplatten von 20 mm Stärke sorgt sie dank der strukturierten Oberfläche R11 A + B + C für Langlebigkeit und Sicherheit eines jeden Bodens im Freien.

LAISTRA 20mm es la nueva gama de productos Atlas Concorde destinada a aplicaciones exteriores. Realizada empleando la tecnología del gres porcelánico técnico rectificado monocalibre en piezas cerámicas monolíticas de 20 mm de espesor, garantiza además resistencia y seguridad para cualquier pavimento exterior gracias al acabado superficial estructurado R11 A + B + C.

LAISTRA 20mm – это новая гамма изделий Atlas Concorde, предназначенная для применения в наружных условиях. Составляющие её монолитные керамогранитные плиты имеют толщину в 20 мм и благодаря структурной поверхности (R11 A+B+C) идеальны для укладки на улице, где обеспечивают стойкость и безопасность покрытий.

60x60 24"x24"
MONOLITHIC Monolitico

THICKNESS spessore
20mm



Trust Gold

20 mm



Trust Titanium

20 mm



Trust Silver

20 mm

LAISTRA 20mm

DESTINATIONS OF USE . Destinazioni d'uso

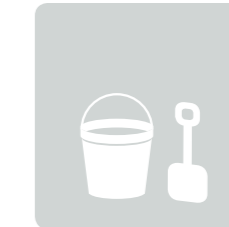
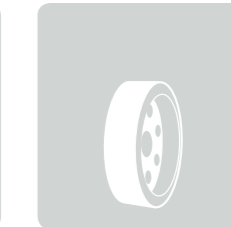
GARDENS
GiardiniTERRACES
TerrazziPATHWAYS
CamminamentiPATIOS
PatiiSWIMMING-POOL
DECKS
Bordi piscinaBATHING RESORTS
SpiaggeCARRIAGEABLE
PATHS
CarrabiliURBAN DESIGN
Arredo urbano

THE ALTERNATIVES OF LAYING . Le alternative di posa

DRYINSTALLATION . La posa a secco



TRADITIONAL INSTALLATION . La posa tradizionale



RAISED INSTALLATION . La posa sopraelevata



ADVANTAGES OF LAISTRA 20mm . I vantaggi di LAISTRA 20mm

- HIGH BREAKAGE LOAD (MORE THAN 1.000 KG PER SLAB)
Resistente ai carichi di rottura (oltre 1.000 kg per lastra)
- EASY TO INSTALL, IT DOES NOT REQUIRE THE LABOUR OF EXPERT TECHNICIANS (IN THE CASE OF DRY INSTALLATION)
Facile da posare, non necessita l'intervento di un posatore (nel caso di posa a secco)
- EASY TO REMOVE, REPLACE AND REUSE WITHOUT MASONRY WORK
Facile da sostituire, riposizionare o rimuovere, senza lavori di muratura
- EXCELLENT ANTI-SLIP FEATURES (R11 A+B+C)
Elevate proprietà antiscivolo (R11 A+B+C)
- RESISTANT TO THERMAL SHOCK
Resistente agli sbalzi termici
- DURABLE AND INALTERABLE OVER TIME
Inalterabile nel tempo
- INABSORBENT (ABSORPTION LEVEL LOWER THAN 0.1%)
Inassorbente (assorbimento inferiore allo 0,1%)
- FROST RESISTANT
Ingelivo
- FIRE-PROOF
Ignifugo
- EASY TO CLEAN, ALLOWS FOR PRESSURE WASHING
Facile da pulire, anche con idropulitrice
- RESISTANT TO SALTS
Resistente al sale
- RESISTANT TO ATTACK FROM MOULDS, MOSS AND INSECTICIDAL TREATMENTS
Inattaccabile da muffe, muschio e trattamenti insetticidi

INDUSTRY STANDARDS: Atlas Concorde would like to inform you that, to date, no industry standards specifically relating to raised floors for outdoor use, currently exist. At the moment, the only available standard is UNI EN 12825 which defines raised floors mainly used in indoor applications. LAISTRA 20mm single-piece slabs meet the requirements of the above mentioned standard. / LA NORMATIVA: Atlas Concorde informa che al momento non esiste una normativa in merito ai pavimenti sopraelevati da esterno. L'unica norma in vigore, la UNI EN 12825, fa riferimento all'utilizzo di tali applicazioni negli interni. I pezzi ceramici monolitici LAISTRA 20mm soddisfano i requisiti della suddetta normativa. / LA RÉGLEMENTATION: Atlas Concorde vous informe qu'il n'existe pas à l'heure actuelle de normes qui régissent l'application en extérieur des planchers surélevés. La seule norme en vigueur, à savoir la UNI EN 12825, se rapporte à l'utilisation des planchers surélevés en intérieur. Les dalles céramiques monolithiques LAISTRA 20 mm satisfont les conditions d'utilisation de cette norme. / NORMEN: Atlas Concorde informiert, dass es derzeit keine gültige Norm für Doppelböden bei einer Verwendung in Außenbereichen gibt. Die momentan einzig gültige Norm ist die UNI EN 12825 die für Doppelböden bestimmt ist, deren hauptsächlichste Verwendung in der Nutzung der Oberfläche innerhalb von Gebäuden liegt. LAISTRA 20mm monolithische Platten, Verweis auf diese Norm, entsprechen jedoch den technischen Leistungen. / LA NORMA: Atlas Concorde informa que en la actualidad no existe una norma para los pavimentos sobreelevados para exteriores. La única normativa vigente, la UNI EN 12825, se refiere al empleo de dichas aplicaciones en interiores. Las piezas cerámicas monolíticas LAISTRA 20mm cumplen los requisitos de la normativa antedicha. / СТАНДАРТИ: Atlas Concorde информирует, что на сегодняшний день не существует никаких стандартов относительно фальшполов для применения исключительно в наружных условиях. В настоящий момент единственным применимым стандартом является UNI EN 12825, который распространяется на фальшполы, предназначенные в основном для внутренней отделки зданий. Монолитные плиты LAISTRA 20mm соответствуют требованиям указанного стандарта.

TRUST

Trim tiles . **Pezzi speciali**

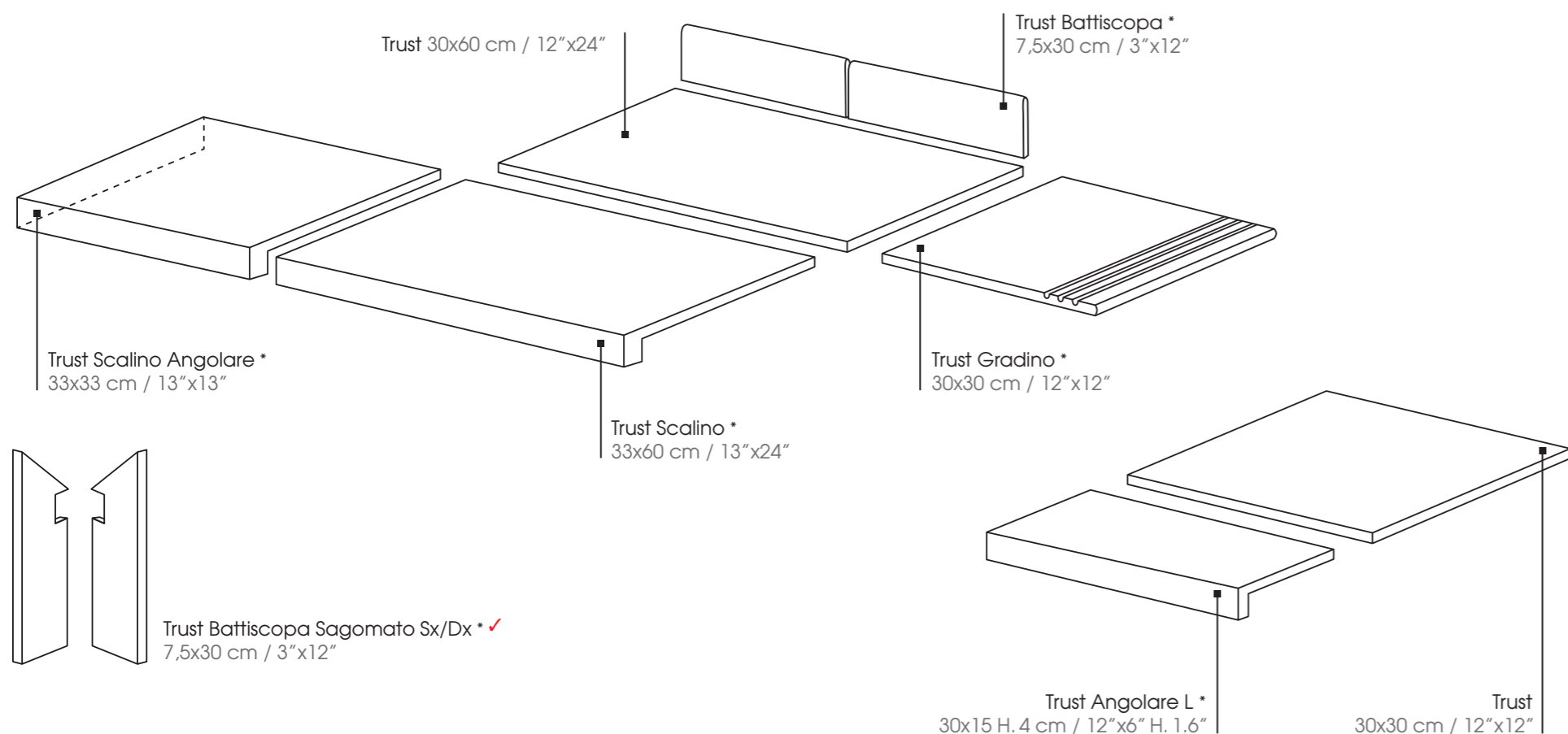

* Available in all colours / Disponibile in tutti i colori
 Disponible dans toutes les couleurs / In allen Farben Verfügbar
 Disponibles en todos los colores / Имеются все цвета

✓ These parts are supplied to order / I pezzi sono disponibili su ordinazione
 Les pièces sont disponibles sur commande / Die Teile sind auf Bestellung lieferbar
 Las piezas se hacen por encargo / Изготавливаются на заказ

Note . Notes

For information and details relating to codes, packaging and weight it is recommended to refer to the latest pricelist / Per le informazioni e i dati relativi a codici, imballaggi e pesi occorre sempre consultare l'ultimo listino aggiornato e in vigore / Pour toutes informations et renseignements concernant les codes, les emballages et les poids, il y a toujours lieu de consulter le dernier tarif en vigueur et mis à jour / Für Informationen und Daten die den Code, die Verpackung und das Gewicht betreffen bitte die aktuellste Preisliste zugrunde legen / Para acceder a la información y a los datos relativos a códigos, embalajes y pesos hay que consultar siempre la última lista de precios actualizada y vigente / Для информации о кодах, упаковках и весе обращайтесь к последнему действующему прайс-листу.

Colours and optical features of the materials illustrated in this catalogue are to be regarded as mere indications / I colori e le caratteristiche estetiche dei materiali illustrati nel presente catalogo sono da ritenersi puramente indicativi / Les coloris et les caractéristiques esthétiques des références illustrées dans le catalogue sont donnés à titre purement indicatif / Die Farben und die ästhetischen Eigenschaften der in diesem Katalog abgebildeten Produkte sind als reine Richtwerte zu betrachten / Los colores y las características estéticas de los materiales ilustrados en el presente catálogo deben ser considerados como puramente indicativos / Цвета и эстетические характеристики описанных в настоящем каталоге материалов являются только ориентировочными.

Atlas Concorde reserves the right to modify any product without notice and will not be liable for any direct or indirect damage resulting from such modifications / Atlas Concorde si riserva di modificare i prodotti senza preavviso, declinando ogni responsabilità su eventuali danni diretti o indiretti derivanti da eventuali modifiche / Atlas Concorde se réserve le droit de modifier ses produits sans préavis et décline toute responsabilité concernant les éventuels dommages directs ou indirects qui pourraient dériver de ces modifications / Atlas Concorde behält sich das Recht vor jederzeit und ohne vorherige Ankündigung, die Produkte zu verändern, und lehnt jede Haftung bei direkten oder indirekten Schäden ab, die von diesen Veränderungen herrühren / Atlas Concorde se reserva el derecho de modificar los productos sin previo aviso, rechaza cualquier responsabilidad sobre eventuales daños directos o indirectos derivados de eventuales modificaciones / Atlas Concorde оставляет за собой право изменять характеристики изделий без предварительного уведомления, отклоняя при этом любую ответственность за прямые или косвенные убытки, возникшие в результате изменений.

Size - Formato:	Thickness - Spessore:	Size - Formato:	Thickness - Spessore:	TECHNICAL PORCELAIN STONEWARE	RECTIFIED MONOCALIBER
45x90 cm / 18"x36"	10 mm	20x60 cm / 8"x24"	10 mm	GRES PORCELLANATO TECNICO	RETTIFICATO MONOCALIBRO
22,5x90 cm / 9"x36"	10 mm	30x30 cm / 12"x12"	9,5 mm	GRÈS CÉRAME TECHNIQUE	RECTIFIÉ MONO-CALIBRE
60x60 cm / 24"x24"	10 mm	15x15 cm / 6"x6"	10 mm Not rectified / Non rettificato	TECHNISCHES FEINSTEINZEUG	GESCHLIFFEN EINKALIBRIG
40x60 cm / 16"x24"	10 mm			GRES PORCELÁNICO TÉCNICO	RECTIFICADO MONOCALIBRE
30x60 cm / 12"x24"	10 mm	60x60 cm / 24"x24"	20 mm Monolithic / Monolitico	ТЕХНИЧЕСКИЙ КЕРАМИЧЕСКИЙ ГРАНИТ	РЕТИФИЦИРОВАННЫЙ В ОДНОМ КАЛИБРЕ



Technical features - compliant with standards EN 14411 (ISO 13006) annex G group Bla
 Caratteristiche tecniche - conforme alla norma EN 14411 (ISO 13006) Appendice G gruppo Bla
 Caractéristiques techniques - Norme retenue: EN 14411 (ISO 13006) Annexe G groupe Bla
 Technische Daten - Bezugsnorm: EN 14411 (ISO 13006) Anlage G Gruppe Bla
 Características técnicas - en conformidad con la norma EN 14411 (ISO 13006) Anexo G grupo Bla
 Технические характеристики – в соответствии со стандартом EN 14411 (ISO 13006), Приложение G группа Bla

	Caratteristica tecnica Technical features Caractéristiques techniques Technische Eigenschaften	Norma Norms Norme Norm	Valore richiesto dalle norme Required standards Valeur prescrite par les normes Normvorgabe		TRUST				LASTRA 20€
			MATT 45x90 - 22,5x90	MATT 15x15	MATT	GRIP	MATT 60x60/24"24"		
Caratteristiche di regolarità Regularly characteristics	Lunghezza e larghezza - Length and width Longuer et largeur - Länge und breite	ISO 10545-2	± 0,6%* ± 0,5%**	± 0,1% ± 0,1%	± 0,1% ± 0,1%	± 0,1% ± 0,1%	± 0,1% ± 0,1%	± 0,1% ± 0,1%	± 0,1% ± 0,1%
	Spessore - Thickness Epaisseur - Stärke		± 5,0%	Conforme Suitable for	Conforme Suitable for	Conforme Suitable for	Conforme Suitable for	Conforme Suitable for	
	Rettilinearità spigoli - Straightness of sides Rectitude des arêtes - Kantengeradheit		± 0,5%	± 0,1%	± 0,1%	± 0,1%	± 0,1%	± 0,1%	
	Ortogonalità - Rectangularity Orthogonalité - Rechtwinkligkeit		± 0,6%	± 0,1%	± 0,1%	± 0,1%	± 0,1%	± 0,1%	
Caratteristiche strutturali Structural characteristics	Planarità - Surface flatness Planimetrie - Ebenflächigkeit	ISO 10545-3	c.c. ± 0,5% e.c. ± 0,5% w ± 0,5%	Non applicabile a strutture forti Not applicable to "strong" structures	Non applicabile a strutture forti Not applicable to "strong" structures	Non applicabile a strutture forti Not applicable to "strong" structures	Non applicabile a strutture forti Not applicable to "strong" structures	Non applicabile a strutture forti Not applicable to "strong" structures	Non applicabile a strutture forti Not applicable to "strong" structures
	Massa d'acqua assorbita - Masse d'eau absorbée Aufgenommene Wassermasse - Water absorption		≤ 0,5%	± 0,1%	± 0,5%	± 0,5%	± 0,5%	± 0,1%	
Caratteristiche Meccaniche massive Bulk mechanical characteristics	Sforzo di rottura - Force de rupture Breaking strength - Bruchlast	ISO 10545-4	S ≥ 1300 N	S ≥ 700 N Linea	S ≥ 2000 N	S ≥ 2000 N	S ≥ 1300 N	S ≥ 1300 N	S ≥ 1000 N
	Resistenza alla flessione - Modulus of rupture Résistance à la flexion - Biegefestigkeit		R ≥ 35 N/mm ²	R ≥ 45 N/mm ²	R ≥ 45 N/mm ²	R ≥ 35 N/mm ²	R ≥ 35 N/mm ²	R ≥ 45 N/mm ²	
Caratteristiche meccaniche superficiali Surface mechanical characteristics	Durezza mohs - Mohs hardness Durete mohs - Ritzhärte nach mohs	EN 101	≥ 6	8	8	8	8	8	8
	Resistenza all'abrasione profonda - Resistance to deep abrasion Resistance a l'abrasion profonde Widerstand gegen tiefenverschleib	ISO 10545-6	≤ 175 mm ³	Conforme Suitable for	Conforme Suitable for	Conforme Suitable for	Conforme Suitable for	Conforme Suitable for	Conforme Suitable for
Caratteristiche termo-igrometriche Thermal and hygrometric characteristics	Coefficiente di dilatazione termica lineare Coefficient of thermal linear expansion Coefficient de dilatation thermique lineaire Wärmeausdehnungskoeffizient	ISO 10545-8	Metodo di prova disponibile Test method available	≤ 7 MK ¹	≤ 7 MK ¹	≤ 9 MK ¹	≤ 9 MK ¹	≤ 7 MK ¹	≤ 7 MK ¹
	Resistenza agli sbalzi termici - Thermal shock resistance Resistance aux variations thermiques Temperaturwechselbeständigkeit	ISO 10545-9	Metodo di prova disponibile Test method available	RESISTE RESISTANT	RESISTE RESISTANT	RESISTE RESISTANT	RESISTE RESISTANT	RESISTE RESISTANT	RESISTE RESISTANT
	Resistenza al gelo - Resistance to frost Resistance au gel - Frostbeständigkeit	ISO 10545-12	Richiesta Required	RESISTE RESISTANT	RESISTE RESISTANT	RESISTE RESISTANT	RESISTE RESISTANT	RESISTE RESISTANT	RESISTE RESISTANT
Caratteristiche di sicurezza Safety characteristics	Coefficiente di attrito dinamico Coefficient de frottement dynamique Dynamischer Reibungskoeffizient - Dynamic friction coefficient	METODO B.C.R.A.	D.M.I. Giugno 1989 n. 236 (μ > 0,40)	> 0,40	> 0,40	< 0,40	> 0,40	> 0,40	
	Coefficiente di attrito statico - Static coefficient of friction Coefficient de frottement statique - Statischer reibungskoeffizient	ASTM C 1028 (S.C.O.F.)	Slip Resistant (≤ 0,60)	≥ 0,60 DRY ≥ 0,60 WET	≥ 0,60 DRY ≥ 0,60 WET	v	≥ 0,60 DRY ≥ 0,60 WET	≥ 0,80 DRY ≥ 0,80 WET	
	Classificazione antisdrucciolo - Non-slip classification Classification antiderapant - Bewertungsgruppe trittsicherheit	DIN 51130	In funzione dell'ambiente o della zona di lavoro - Basing on the environment or on the working area	R10	R10	R10	R12	R11	
	Classificazione antisdrucciolo - Non-slip classification Classification antiderapant - Bewertungsgruppe trittsicherheit	DIN 51097	In funzione delle zone bagnate soggette a calpestio a piedi scalzi Basing on the Wet-loaded barefoot areas	A+B	A+B	A+B	A+B+C	A+B+C	
Caratteristiche chimiche Chemical characteristics	Resistenza ai prodotti chimici di uso domestico ed agli additivi per piscina Resistance to household chemicals and swimming pool salts Résistance aux produits chimiques à usage domestique et aux adjuvants pour piscines Beständigkeit gegen Haushaltschemikalien und Badewasserzusätze	ISO 10545-13	Classe UB min. Class UB min.	UA	UA	UA	UA	UA	
	Resistenza a basse concentrazioni di acidi e alcali Resistance to low concentrations of acids and alkalis Résistance aux acides et aux alcalis à basse concentration Beständigkeit gegen niedrigkonzentrierte Säuren und Laugen		Secondo la classificazione indicata dal fabbricante Manufacturer to state classification	ULA	ULA	ULA	ULA	ULA	
	Resistenza ad alte concentrazioni di acidi e alcali Resistance to high concentrations of acids and alkalis Résistance aux acides et aux alcalis à haute concentration Beständigkeit gegen hochkonzentrierte Säuren und Laugen		Metodo di prova disponibile Test method available	UHA	UHA	UHA	UHA	UHA	
	Resistenza alle macchie - Resistance to staining Resistance aux taches - Widerstand gegen fleckenbildung	ISO 10545-14	Metodo di prova disponibile Test method available	5	5	5	5	5	

* Deviazione ammissibile, in per cento, della dimensione media di ogni piastrella (2 o 4 lati) della dimensione di fabbricazione.
 The deviation, in percent, of the average size for each tile (2 or 4 sides) from the work size.
 ** Deviazione ammissibile, in per cento, della dimensione media di ogni piastrella (2 o 4 lati) della dimensione media dei 10 campioni (20 o 40 lati).
 The deviation, in percent, of the average size for each tile (2 or 4 sides) from the average size of the 10 test specimens (20 or 40 sides).
 c.c. Curvatura del centro in rapporto alla diagonale calcolata secondo le dimensioni di fabbricazione. - Centre curvature, related to diagonal calculated from the work sizes.
 e.c. Curvatura dello spigolo in rapporto alle dimensioni di fabbricazione corrispondenti. - Edge curvature, related to the corresponding work sizes.
 w Svergolamento in rapporto alla diagonale calcolata secondo le dimensioni di fabbricazione. - Warpage, related to diagonal calculated from the work sizes.

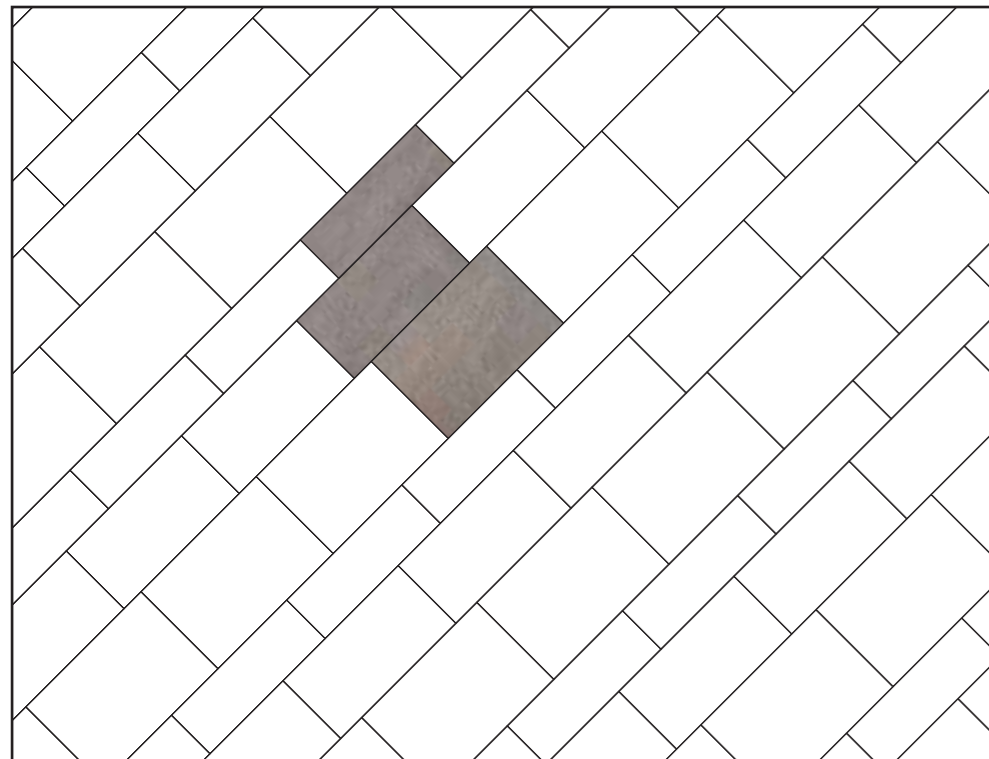

01

20x60	22,2%
30x60	33,3%
40x60	44,4%



02

30x30	16,7%
20x60	22,2%
30x60	16,7%
40x60	44,4%

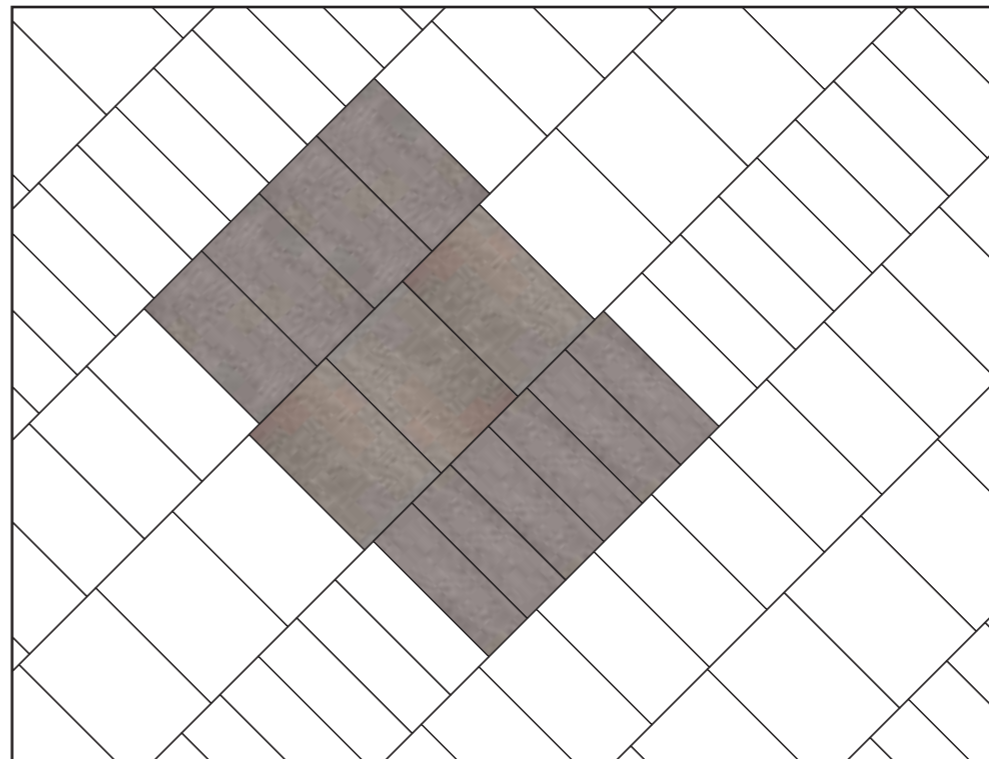

05

20x60	33,3%
30x60	33,3%
40x60	33,3%



06

45x90	66,7%
22.5x90	33,3%

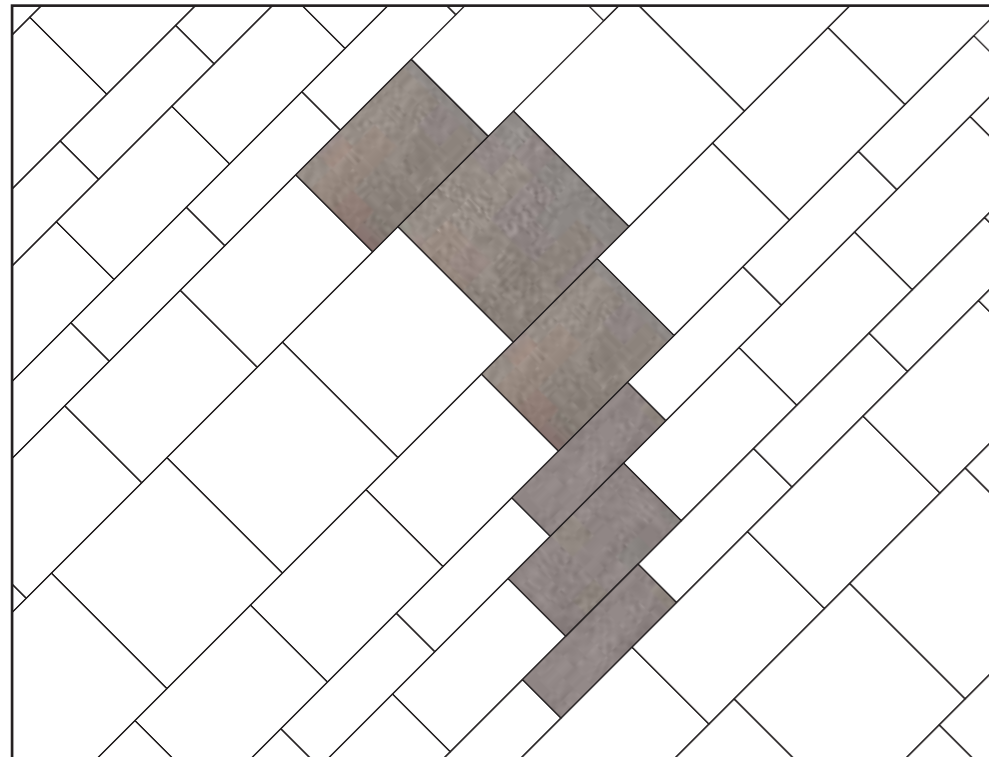

03

20x60	19,0%
30x60	14,3%
40x60	38,1%
60x60	28,6%

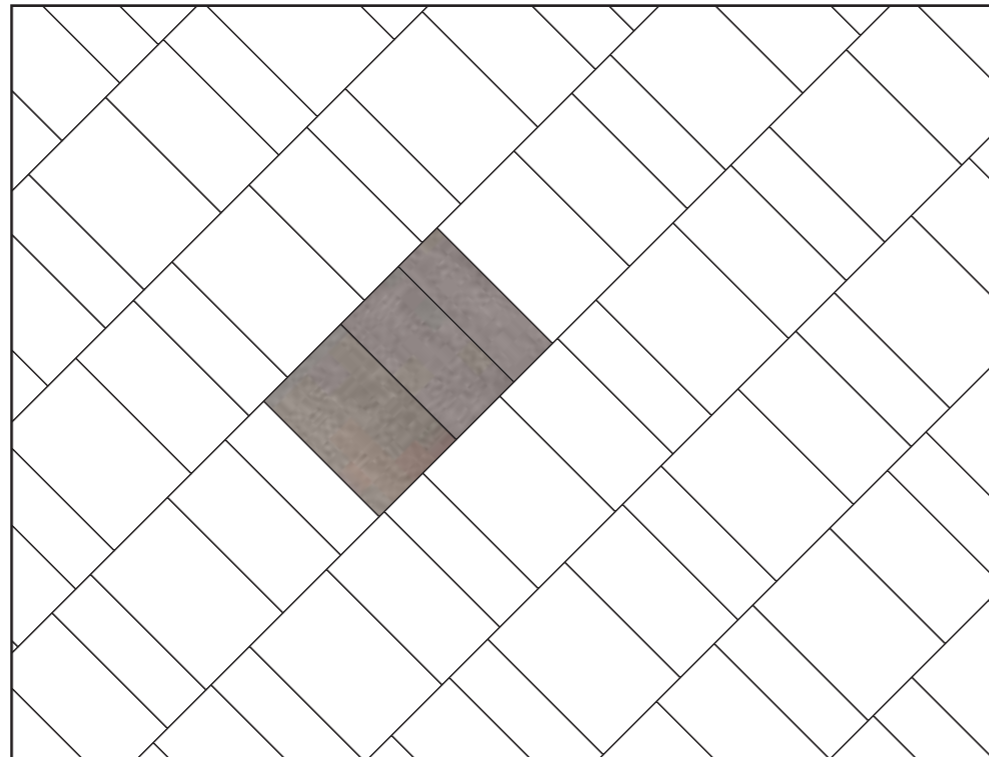

04

20x60	22,2%
30x60	33,3%
40x60	44,4%

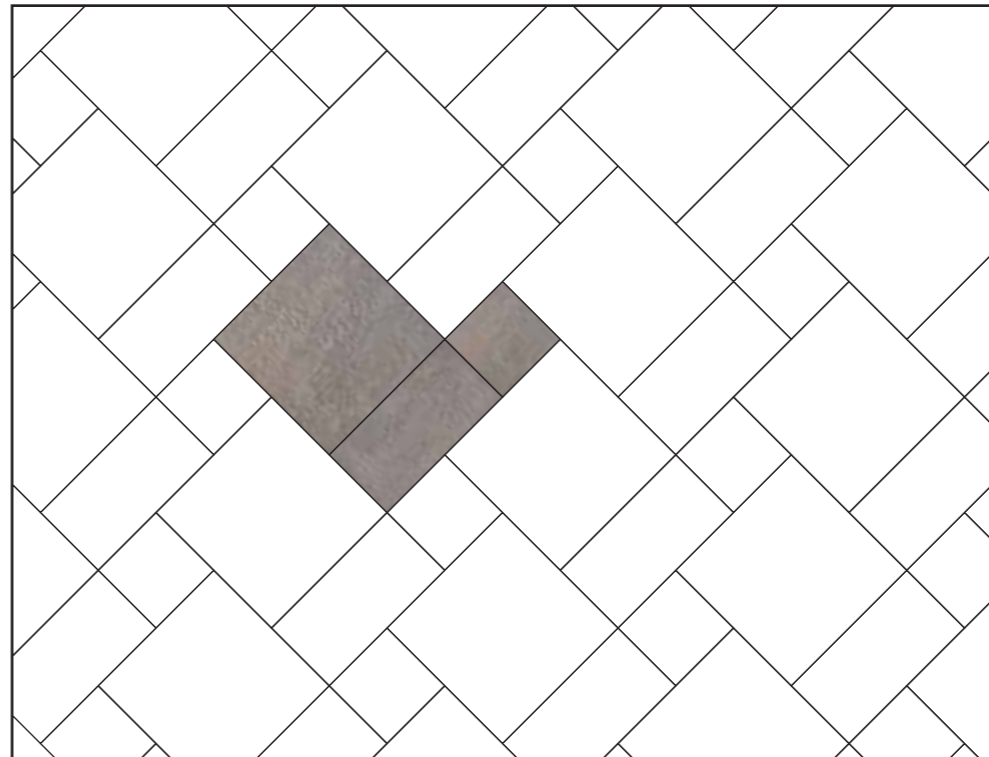

07

30x30	14,3%
30x60	28,6%
60x60	57,1%

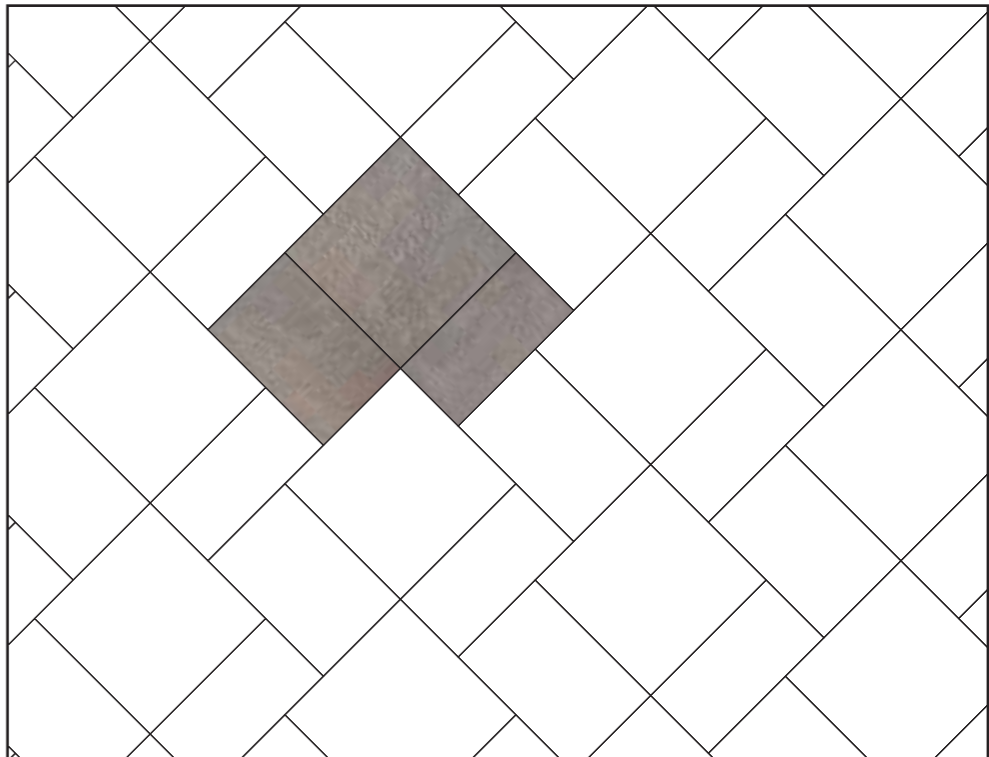

08

30x60	23,1%
40x60	30,8%
60x60	46,2%

For multi-size modular installation patterns, Atlas Concorde recommends 3 mm grout lines / Per la posa multiformato modulare Atlas Concorde consiglia una fuga di 3 mm / En cas de pose complexe de composition multiformats, Atlas Concorde conseille de laisser un joint de 3 mm / Für eine modulare Verlegung im Multiformat empfiehlt Atlas Concorde eine Fuge von 3 mm / Para la colocación multiformato modular Atlas Concorde aconseja una junta de 3 mm / Для модульной мультиформатной укладки Atlas Concorde рекомендует шов шириной в 3 мм.

For multi-size modular installation patterns, Atlas Concorde recommends 3 mm grout lines / Per la posa multiformato modulare Atlas Concorde consiglia una fuga di 3 mm / En cas de pose complexe de composition multiformats, Atlas Concorde conseille de laisser un joint de 3 mm / Für eine modulare Verlegung im Multiformat empfiehlt Atlas Concorde eine Fuge von 3 mm / Para la colocación multiformato modular Atlas Concorde aconseja una junta de 3 mm / Для модульной мультиформатной укладки Atlas Concorde рекомендует шов шириной в 3 мм.



Lo standard LEED (Leadership in Energy and Environmental Design) è un sistema di rating per lo sviluppo di edifici “verdi”. Elaborato dall’US Green Building Council e riconosciuto a livello internazionale, indica i requisiti per costruire edifici eco-compatibili, capaci di funzionare in maniera sostenibile ed autosufficiente a livello energetico e di avere un basso impatto sull’ambiente durante tutto il loro ciclo di vita. Il sistema si basa sull’attribuzione di crediti per ciascuno dei requisiti: dalla somma dei crediti deriva il livello di certificazione ottenuto. Anche le piastrelle ceramiche possono contribuire al raggiungimento dei crediti LEED. Ceramiche Atlas Concorde è membro dell’US Green Building Council e socio ordinario del Green Building Council Italia, ente promotore delle tematiche LEED in Italia.

Le standard LEED (Leadership in Energy and Environmental Design) est un système pour l’évaluation visant au développement d’édifices écologiques. Élaboré par l’US Green Building Council, il est reconnu au niveau international et précise les critères pour construire des édifices compatibles avec l’environnement, capables de fonctionner de manière durable et autonome d’un point de vue énergétique tout en ayant un faible impact sur l’environnement durant tout leur cycle de vie. Le système se base sur l’attribution de crédits pour chacun des critères. La somme de ces crédits détermine le niveau de certification obtenu. Le carrelage en céramique peut lui aussi contribuer à obtenir des crédits LEED. Ceramiche Atlas Concorde fait partie de l’US Green Building Council et est membre ordinaire du Green Building Council Italia, organisme de promotion de la thématique du LEED en Italie.

El estándar LEED (Leadership in Energy and Environmental Design) es un sistema de clasificación para el desarrollo de edificios “verdes”. Elaborado por el US Green Building Council y reconocido a nivel internacional, indica los requisitos para construir edificios eco-compatibles, capaces de funcionar de manera sostenible y autosuficiente a nivel energético y de tener un bajo impacto ambiental durante el ciclo de vida completo. El sistema se basa en la atribución de créditos por cada uno de los requisitos: de la suma de los puntos deriva el nivel de certificación obtenido. También los azulejos cerámicos pueden contribuir al conseguimiento de los puntos LEED. Cerámica Atlas Concorde es miembro del US Green Building Council y socio ordinario del Green Building Council Italia, ente promotor de los temas LEED en Italia.

The LEED standard (Leadership in Energy and Environmental Design) is a rating system dedicated to the development of “green” buildings. Developed by the US Green Building Council and internationally recognised, it points out the necessary requirements to build eco-compatible projects, capable of functioning in a sustainable and autonomous way from an energy point of view, as well as having a low environmental impact throughout their entire life cycle. This system is based on the allocation of credits for each single requirement: the total amount of credits defines the obtained certification level. Also ceramic tiles can contribute to the achievement of LEED points. Ceramiche Atlas Concorde is a member of the US Green Building Council as well as ordinary member of the Green Building Council Italia, the Italian promoter entity of the LEED standard.

Der LEED Standard (Leadership in Energy and Environmental Design) ist ein Bewertungssystem, das die Entwicklung “grüner” Gebäude fördert. Ausgearbeitet vom US Green Building Council ist dieser Standard international anerkannt und gibt Grundbedingungen für den Bau von öko-kompatiblen d.h. nachhaltigen und in Bezug auf Energie unabhängigen Gebäuden, die während ihres gesamten Lebenszykluses geringe Wirkung auf die Umwelt haben, vor. Das System beruht auf Credits, die man erhält, wenn diese Grundbedingungen des ökologischen Bauens erfüllt sind. Aus der Summe der Credits bestimmt sich das erreichte Zertifikationsniveau. Auch Fliesen können zum Erreichen der LEED Credits beitragen. Ceramiche Atlas Concorde ist Mitglied des US Green Building Council und ordentliches Mitglied des Green Building Council Italia, Förderer des LEED Konzepts in Italien.

LEED (Лидерство в области энергоэффективного и экологического проектирования) – признанная на международном уровне сертификационная система оценки зданий по степени экологической чистоты. Разработана Советом экологического строительства США (US Green Building Council) и устанавливает требования к проектированию и строительству зданий с точки зрения энергоэффективности, влияния на здоровье человека и окружающую среду. Система основывается на присвоении баллов по каждому из оценочных параметров, а по сумме накопленных баллов определяется уровень сертификации. Керамические плитки также могут содействовать получению баллов LEED. Ceramiche Atlas Concorde является членом Совета экологического строительства США и действительным членом Итальянского совета по экологическому строительству (Green Building Council Italia), одна из основных задач которого – распространение принципов LEED в Италии.



Il marchio Made in Italy di Atlas Concorde è sinonimo di stile, qualità ed etica. Avendo aderito con convinzione al Codice Etico di Confindustria Ceramica, Atlas Concorde appone il marchio Made in Italy su tutti i prodotti studiati, progettati e realizzati in Italia, nella fattispecie tutte le piastrelle di ceramica, le decorazioni e la maggioranza dei pezzi speciali. Solo un ristretto numero di questi ultimi è fabbricato in Spagna. I prodotti Atlas Concorde sono inoltre realizzati con tecnologie rispettose dell’ambiente, utilizzando materie prime eccellenti e sicure, garantendo le migliori condizioni di lavoro. Per queste ragioni il Made in Italy di Atlas Concorde è espressione di valori forti quali stile, design, qualità del prodotto, attenzione all’ambiente e alle persone.

Le label Made in Italy d’Atlas Concorde est synonyme de style, de qualité et d’éthique. Atlas Concorde a adhéré au Code Éthique de Confindustria Céramique avec conviction et appose le label Made in Italy sur tous les produits étudiés, projetés et fabriqués en Italie : dans ce cas, sur tous les carreaux en céramique, les décorations et la plupart des pièces spéciales. Seul un nombre restreint de ces dernières est fabriqué en Espagne. Les produits Atlas Concorde sont en outre fabriqués avec des technologies qui respectent l’environnement et utilisent des matières premières excellentes et sûres, dans la garantie des meilleurs conditions de travail. Pour ces raisons, le Made in Italy d’Atlas Concorde exprime des valeurs fortes telles que le style, le design, la qualité du produit et le respect de l’environnement et des personnes.

La marca Made in Italy de Atlas Concorde es sinónimo de estilo, calidad y ética. Adhiriendo con convicción el Código Ético de Confindustria Cerámica, Atlas Concorde señala con la marca Made in Italy todos los productos estudiados, diseñados y realizados en Italia, en este caso todas las baldosas de cerámica, las decoraciones y la mayoría de piezas especiales. Sólo un restringido número de estas últimas se fabrica en España. Los productos Atlas Concorde se realizan además con tecnologías que respetan el medio ambiente, usando materias primas excelentes y seguras, garantizando las mejores condiciones de trabajo. Por dichas razones el Made in Italy de Atlas Concorde es la manifestación de valores sólidos como estilo, diseño, calidad del producto, cuidado del medio ambiente y las personas.



Ceramics of Italy

www.confindustriaceramica.it

Il marchio Ceramics of Italy contrassegna esclusivamente i prodotti ceramici effettivamente realizzati in Italia da un’azienda associata a Confindustria Ceramica che ha sottoscritto il Codice Etico. Il Codice, redatto dalla stessa Confindustria Ceramica, impegna a comunicare con chiarezza l’origine dei prodotti.

Le label Ceramics of Italy distingue exclusivement les produits en céramique qui sont effectivement fabriqués en Italie par les sociétés associées à Confindustria Céramique ayant souscrit le Code Éthique. Ce Code, rédigé par Confindustria Céramique, engage ceux qui le souscrivent à communiquer clairement l’origine des produits.

La marca Ceramics of Italy distingue exclusivamente los productos cerámicos realizados efectivamente en Italia por una empresa afiliada a Confindustria Cerámica que ha suscrito el Código Ético. El Código, redactado por Confindustria Cerámica, compromete a quien lo ratifica a comunicar con claridad el origen de los productos.



www.eco-label.com

Il marchio comunitario di qualità ecologica certifica il rispetto di criteri ambientali stabiliti a livello europeo ed è rilasciato esclusivamente a prodotti con un ridotto impatto ambientale rispetto ai concorrenti. Ecolabel è quindi un attestato di eccellenza che segnala e promuove i prodotti più ecologici e rispettosi dell’ambiente. I criteri ambientali valutano l’impatto in tutte le fasi del ciclo di vita: estrazione delle materie prime, processi di lavorazione, distribuzione, utilizzo, smaltimento.

Le label communautaire de qualité écologique certifie le respect de critères environnementaux au niveau européen et n’est délivré qu’aux produits qui ont un impact environnemental réduit par rapport aux concurrents. L’Écolabel est donc une attestation d’excellence qui signale et promeut les produits les plus écologiques et respectueux de l’environnement. Les critères environnementaux considèrent l’impact pour chaque phase du cycle de vie : extraction des matières premières, processus de fabrication, distribution, utilisation, élimination.

La marca comunitaria de calidad ecológica certifica el respeto de los criterios ambientales establecidos a nivel europeo y es asignada exclusivamente a productos de impacto ambiental reducido respecto a la competencia. Ecolabel es entonces un atestado de excelencia que indica y promueve los productos altamente ecológicos y respetuosos con el ambiente. Los criterios ambientales evalúan el impacto en todas las fases del ciclo de vida: extracción de las materias primas, procesos de elaboración, distribución, uso y eliminación.

The Made in Italy logo of Atlas Concorde stands for style, quality and ethics. Having firmly adhered to the Ethical Code promoted by Confindustria Ceramica, Atlas Concorde places the Made in Italy logo on all the products designed and produced in Italy, that is to say ceramic tiles, decorations and the majority of special trim tiles. Only a small amount of the latter is manufactured in Spain. Atlas Concorde products are produced using eco-friendly technologies, top quality and safe raw materials with the best working conditions guaranteed for our personnel. For these reasons, Atlas Concorde’s Made in Italy is the expression of strong values such as style, design, product quality, and respect for the environment and the people who live in it.

Die Marke Made in Italy von Atlas Concorde ist ein Synonym für Stil, Qualität und Ethik. Aus Überzeugung haben wir uns dem Ethischen Kodex der Confindustria Ceramica (Dachverband der ital. Unternehmen und Unternehmensverbände der Keramikbranche) angeschlossen. Atlas Concorde bringt die Marke Made in Italy auf allen seinen Produkten an die in Italien geplant, entwickelt und realisiert werden, d.h. alle Keramikfliesen, Dekore, Bordüren und der Hauptteil der Spezialteile. Nur eine geringe Anzahl der letzteren werden in Spanien gefertigt. Die Produkte von Atlas Concorde werden darüberhinaus unter Verwendung ausgezeichneter und sicherer Rohstoffe mittels umweltschützender Technologien unter besten Arbeitsbedingungen hergestellt. Aus diesen Gründen ist Made in Italy von Atlas Concorde ein Ausdruck starker Werte wie Stil, Design, Produktqualität.

Маркировка Made in Italy на плитках Atlas Concorde – синоним стиля, качества и этики. С уверенностью приняв «Этический кодекс» федерации Confindustria Ceramica (ассоциация предприятий керамической отрасли), компания отмечает этим знаком все изделия, разработанные и изготовленные в Италии: керамические плитки, декоры и большинство специальных элементов. Лишь ограниченная часть последних производится в Испании. Изделия Atlas Concorde изготовлены с использованием надёжного, высококачественного сырья и передовых технологий, гарантирующих экологическую совместимость производства и оптимальные рабочие условия. Для Atlas Concorde Made in Italy – это выражение важных ценностей, таких как стиль, дизайн, качество. Это уважение к человеку и природе.

The Ceramics of Italy logo is an exclusive identification on ceramic products which have effectively been made in Italy by companies that are a part of the Confindustria Ceramica and who adhered to its Ethical Code. This Code, promoted and created by Confindustria Ceramica, commits all companies to communicate, clearly and with transparency, the origin of their products.

Die Marke Ceramics of Italy zeichnet ausschließlich Keramikprodukte aus, die in Italien, von Unternehmen, welche dem Dachverband der ital. Unternehmen und Unternehmensverbände der Keramikbranche angehören und sich dem Ethischen Kodex verschrieben haben, hergestellt werden. Der Kodex, von diesem Dachverband ins Leben gerufen, verpflichtet sich zur klaren Angabe und Mitteilung der Herkunft der Produkte.

Знаком Ceramics of Italy маркируются только керамические изделия, которые изготовлены действительно в Италии предприятием-членом федерации Confindustria Ceramica, подписавшим “Этический кодекс”. Кодекс разработан самой федерацией и обязывает яно указывать происхождение товара.

The European logo of environmental quality certifies compliance with the European environmental criteria and is only given to products that, compared to those of competitors, have a low environmental impact. Ecolabel is a quality award that identifies and promotes the most eco-friendly products. The environmental criteria evaluate the impact on the entire lifecycle: extraction of raw materials, manufacturing, distribution, use and final disposal.

Die Marke ökologischer Qualität der europäischen Gemeinschaft, das europäische Umweltzeichen (Ecolabel), bestätigt die Einhaltung umweltschonender Produktionskriterien, die auf europäischer Ebene vereinbart worden sind, und wird ausschließlich an Produkte, deren Auswirkungen auf die Umwelt im Vergleich zu Mitbewerbern gering sind, verliehen. Ecolabel ist ein Attest für Außergewöhnlichkeit und fördert und unterstützt ökologische und umweltverträgliche Produkte. Die umweltschonende Kriterien gelten in allen Phasen des Lebenszyklus eines Produktes: beim Abbau von Rohstoffen, bei Bearbeitungsprozessen, beim Vertrieb und bei der Entsorgung.

Знак экологического качества ЕС удостоверяет соблюдение экологических требований, установленных на европейском уровне, и присваивается товарам, оказывающим меньшее воздействие на окружающую среду, по сравнению с существующими аналогами. Следовательно, Ecolabel является свидетельством безопасности продукции и внимательного отношения производителя к вопросам охраны природы. При выдаче сертификата оценивается воздействие изделий на среду на протяжении всего их жизненного цикла: от добычи сырья и производства до сбыта, эксплуатации и утилизации.



atlas concorde

CERAMICHE ATLAS CONCORDE S.P.A.
41042 Spezzano di Fiorano (MO) Italia - Via Canaletto, 141
info@atlasconcorde.it - www.atlasconcorde.it

ATLAS CONCORDE USA, INC.
2830 SW 42 Street - Hollywood, FL 33312 - U.S.A.

ООО "ATLAS CONCORDE RUSSIA"
Business centre "Meliora Place" - Prospekt Mira 6 - 129090 Mosca, Russia
info@atlasconcorde.ru - www.atlasconcorde.ru

Copyright 2012 by Ceramiche Atlas Concorde S.p.A. (Spezzano di Fiorano, MO - Italy)