



water visions 03

CERAMICS FOR INNOVATIVE POOLS, WELLNESS AND SPAS



CASALGRANDE
PADANA
Pave your way

water visions 03

index

04 INTRO

PROGETTARE CON L'ACQUA

DESIGNING WITH WATER

CONCEPTS D'EAU

MIT WASSER GESTALTEN

08 **BiosCeramics - Antibacterial®**

Ceramiche bioattive

BiosCeramics - Antibacterial®

Bioactive ceramics

BiosCeramics - Antibacterial®

Céramiques bioactives

BiosCeramics - Antibacterial®

Bioaktive Keramik

12 **Soluzioni personalizzate e assistenza tecnica**

CUSTOM SOLUTIONS AND TECHNICAL SUPPORT

SOLUTIONS PERSONNALISEES ET ASSISTANCE TECHNIQUE

INDIVIDUELLE LÖSUNGEN UND TECHNISCHE

UNTERSTÜTZUNG

14 **Sicurezza**

e norme antiscivolo

SAFETY AND NON-SLIP STANDARDS

SÉCURITÉ ET NORMES ANTIDERAPANTES

SICHERHEIT UND RUTSCHHEMMUNGSNORMEN

18 **Percorsi per le disabilità visive**

PATHS FOR VISUALLY DISABLED PEOPLE

PARCOURS POUR MALVOYANTS ET AVEUGLES

LEITWEGE FÜR SEHBEHINDERTE

20 SPORT&FUN

PIASTRELLE E PEZZI SPECIALI SPECIFICI PER PISCINE E IMPIANTI NATATORI

CERAMIC TILES AND FITTINGS FOR SWIMMING POOLS AND AQUATIC CENTERS

CARREAUX ET PIECES SPECIALES POUR PISCINES ET CENTRES AQUATIQUES

FLIESEN UND FORMSTÜCKE FUER SCHWIMMBÄDERN UND SCHWIMMANLAGEN

22 **Landscape_GRESPLUS**

piastrelle in gres porcellanato smaltato

GLAZED PORCELAIN TILES

CARREAUX EN GRES CERAME EMAILLE

GLASIERTE FEINSTEINZEUG-FLIESEN

24 **superfici** / surfaces / surface / oberflächen

26 **colori** / colours / couleurs / farben

28 **mosaici** / mosaics / mosaïque / mosaik

30 **decori** / decors / decorations / dekore

34 **Elementi GRANITOGRES**

piastrelle in gres porcellanato non smaltato

UNGLAZED PORCELAIN TILES

CARREAUX EN GRES CERAME NON EMAILLE

UNGLASIERTE FEINSTEINZEUG-FLIESEN

36 **superfici** / surfaces / surface / oberflächen

38 **colori** / colours / couleurs / farben

40 **Padana Trim**

pezzi speciali e sistema Trim-Box

TRADITIONAL FITTINGS AND TRIM-BOX SYSTEM

PIECES SPECIALES ET SYSTEME TRIM-BOX

TRADITIONELLE FORMSTÜCKE UND DAS SYSTEM TRIM-BOX

60 **Padana Grid**

griglie e accessori

GRATINGS AND ACCESSORIES

GRILLES ET ACCESSOIRES

ROSTE UND ZUBEHÖR

68 **Padana Deck_Sport&Fun**

canalette per esterni vasca

CHANNELS FOR POOL DECKS

CANIVEAUX DE PLAGE

BECKENUMGANGSRINNEN

76 **Finishing Systems**

bordi vasca e altri elementi costruttivi

POOL BORDERS AND OTHER POOL ELEMENTS

TÊTES DE BASSIN ET AUTRES ÉLÉMENTS DE PISCINE

BECKENKÖPFE UND ANDERE BAUELEMENTE

116 WELLNESS&SPA

CERAMICHE PER WELLNESS E SPA
CERAMICS FOR WELLNESS AND SPA
CERAMIQUES POUR WELLNESS ET SPA
KERAMIK FÜR WELLNESS UND SPA

118 **Naturali come l'acqua**

AS NATURAL AS WATER
NATURELLES COMME L'EAU
NATÜRLICH WIE DAS WASSER

120 **Mineral Chrom_PIETRE NATIVE**

122 **colori** / colours / couleurs / farben

124 **decori** / decors / decorations / dekore

126 **pezzi speciali** / fittings / pièces spéciales / formstücke

132 **bordi vasca e altri elementi costruttivi**

pool borders and other pool elements
têtes de bassin et autres éléments de piscine
Beckenköpfe und andere Bauelemente

144 **Amazzonia_PIETRE NATIVE**

146 **colori** / colours / couleurs / farben

148 **decori** / decors / decoration / dekore

150 **pezzi speciali** / fittings / pièces spéciales / formstücke

158 **bordi vasca e altri elementi costruttivi**

pool borders and other pool elements
têtes de bassin et autres éléments de piscine
Beckenköpfe und andere Bauelemente

174 **Newood_GRANITOKER**

176 **colori** / colours / couleurs / farben

178 **pezzi speciali** / fittings / pièces spéciales / formstücke

181 **bordi vasca e altri elementi costruttivi**

pool borders and other pool elements
têtes de bassin et autres éléments de piscine
Beckenköpfe und andere Bauelemente

184 **Country Wood_GRANITOKER**

190 **Marte_GRANITOGRES**

196 **Pietre di Sardegna_PIETRE NATIVE**

200 **Pietra Baugé_PIETRE NATIVE**

202 **Chalon_PIETRE NATIVE**

204 **Boulder_PIETRE NATIVE**

206 **Petra_PIETRE NATIVE**

210 **Eco Concrete_GRESPLUS**

212 **Padana Deck_Wellness&Spa**

canalette per esterni vasca
CHANNELS FOR POOL DECKS
CANIVEAUX DE PLAGE
BECKENUMGANGSRINNEN

220 COMPLEMENTARY PRODUCTS

PRODOTTI COMPLEMENTARI
PRODUITS COMPLEMENTAIRES
ERGÄNZUNGSPRODUKTE

230 TECH INFO

CARATTERISTICHE TECNICHE
TECHNICAL FEATURES
CARACTERISTIQUES TECHNIQUES
TECHNISCHE EIGENSCHAFTEN

238 **Mosaici**

MOSAICS
MOSAÏQUE
MOSAIKEN

239 **Manutenzione e pulizia** **Maintenance and cleaning** **Entretien et nettoyage** **Instandhaltung und reinigung**



INTRO

PROGETTARE CON L'ACQUA

DESIGNING WITH WATER

CONCEPTS D'EAU

MIT WASSER GESTALTEN

Progettare con l'acqua

DESIGNING WITH WATER
CONCEPTS D'EAU
MIT WASSER GESTALTEN

Fare piscine e farle bene è la mission di Casalgrande Padana. I grandi impianti natatori, i centri termali, i parchi acquatici ed anche le piscine private hanno sempre maggiore diffusione e sono diventati non solo importanti realizzazioni architettoniche ma anche luoghi sociali sempre da vivere pienamente.

La ricerca sui materiali, l'analisi delle criticità legate al progetto e l'applicazione di soluzioni tecniche evolute sono il nucleo delle attività del team di tecnici di Casalgrande Padana che unisce capacità ingegneristiche ad una lunga esperienza concreta e diretta sul campo.

La prima parte del catalogo illustra i prodotti specificatamente studiati e sviluppati per gli impianti natatori sportivi mentre la seconda parte comprende una selezione di prodotti della gamma Casalgrande Padana dalla particolare ricercatezza estetica e materica rielaborati e corredati per l'impiego in piscine, aree wellness e spa.

Producing quality swimming pools is the mission of Casalgrande Padana. Large swimming facilities, spas and thermal baths, water parks and even private pools are becoming increasingly popular and have turned into remarkable architectural feats, but also into fully exploited and frequented social venues.

Material research, project analysis and the use of evolved technical solutions are at the core of the work of the Casalgrande Padana's design team, who combine engineering expertise with a long and direct field experience.

The first part of the catalogue describes those products specifically designed and developed for competition pools, while the second section delves into a selection of products of the Casalgrande Padana range that stand out for the remarkable aesthetic value, conceived and provided for use in pools, wellness centres and spas.

La mission de Casalgrande Padana est la conception de piscines de qualité. Les grands centres nautiques, les stations thermales, les parcs aquatiques et les piscines privées sont de plus en plus répandus, s'étant transformés en lieux de socialisation, en plus d'être des œuvres architecturales importantes.

La recherche sur les matières, l'analyse des points critiques liés aux projets et l'application de solutions techniques évoluées sont les activités principales de l'équipe technique de Casalgrande Padana, qui associe compétences de génie civil et une longue expérience sur le terrain.

La première partie de ce catalogue décrit les produits spécialement conçus et développés pour les centres nautiques, tandis que la deuxième inclut un éventail de produits de la gamme Casalgrande Padana, de très haute qualité esthétique et matérielle, revisités et assortis pour leur emploi dans les piscines des centres de bien-être et des spas.

Schwimmbäder zu konstruieren und zwar gut, das ist die Mission von Casalgrande Padana. Große Schwimmanlagen, Kurmittelhäuser, Wasserparks sowie Privatschwimmbäder sind immer stärker verbreitet und haben nicht nur als bedeutende architektonische Bauten sondern auch als vollwertige soziale Orte eine hohe Wertigkeit erlangt.

Die Materialforschung, die Analyse der kritischen Punkte des Projektes sowie die Anwendung fortschrittlicher technischer Lösungen bilden den Tätigkeitsschwerpunkt des technischen Teams von Casalgrande Padana, das ingenieurtechnische Fähigkeiten und eine langjährige konkrete Erfahrung direkt vor Ort miteinander in Einklang bringt.

Der erste Teil des Katalogs illustriert die Produkte, die spezifisch für die Wassersportanlagen erforscht und entwickelt wurden, während der zweite Teil eine Auswahl von Produkten mit besonders hochwertigen ästhetischen und materiellen Eigenschaften des Sortiments Casalgrande Padana enthält, die überarbeitet und für die Verwendung in Schwimmbädern, Wellnesszentren und Heilbädern ausgelegt wurden.



bios antibacterial®

BIOS CERAMICS®

Bios Ceramics® è la più avanzata ed esclusiva generazione di ceramiche bioattive per applicazioni architettoniche, certificate ed ecocompatibili, con caratteristiche antibatteriche, autopulenti e di riduzione degli agenti inquinanti.

La produzione si articola nell'ambito di due trattamenti estremamente specializzati e continuamente soggetti a migliorie prestazionali, **Bios Self-Cleaning®** e **Bios Antibacterial®**, in grado di rispondere a qualsiasi esigenza applicativa in interni ed esterni, in funzione delle specifiche condizioni di impiego.

Una proposta trasversale e diversificata che in oltre vent'anni di sperimentazione ha permesso di soddisfare la creatività di progettisti e clienti in tutto il mondo, grazie alle ricercate finiture e ai diversi formati disponibili su tutta la gamma prodotti di Casalgrande Padana.

BIOS SELF-CLEANING®

Il trattamento **Bios Self-Cleaning®** è impiegato nella realizzazione di rivestimenti esterni di facciata e involucri ventilati.

Grazie alla speciale **tecnologia Hydrotect®**, in presenza di luce solare **Bios Self-Cleaning®** attiva una reazione in grado di abbattere non solo i batteri, ma soprattutto gli inquinanti

presenti nell'aria e decomporre lo sporco che si deposita sulla superficie delle piastrelle, in modo che possa essere rimosso dallo scorrere dell'acqua piovana, grazie alla superidrofilia della superficie ceramica.

BIOS ANTIBACTERIAL®

Il trattamento **Bios Antibacterial®** è in grado di conferire proprietà antibatteriche alla superficie ceramica, grazie ad una tecnologia agli ioni d'argento che blocca il metabolismo dei batteri.

LA FUNZIONE ANTIBATTERICA

Contrariamente ai disinfettanti comuni, un battericida come **Bios Antibacterial®** è in grado di assicurare una protezione costante contro i microrganismi, combattendo i microbi in tre modi: interrompe il metabolismo cellulare, blocca i processi di trasporto nella membrana e impedisce la moltiplicazione delle celle.

Dopo severe prove di laboratorio, il trattamento è risultato capace di abbattere al 99% i quattro principali ceppi batterici responsabili delle infezioni che si registrano in ambito ospedaliero e che sono stati adottati come standard perché rappresentano la categoria più aggressiva, in alcuni casi anche resistente agli antibiotici: *Staphylococcus aureus*, *Enterococcus faecalis*, *Escherichia coli*, *Pseudomonas aeruginosa*.

SEMPRE ATTIVO

Il trattamento antibatterico è incorporato in modo permanente nel prodotto ceramico ed è sempre attivo, giorno e notte, con o senza luce solare, e non necessita di raggi UV per l'attivazione.

ANTI-ODORE E ANTI-MUFFA

Oltre al potere battericida, **Bios Antibacterial®** evita la formazione di muffe, lieviti e funghi, principali responsabili dei cattivi odori, rendendo gli ambienti più sani e gradevoli all'olfatto.

FACILE DA PULIRE E INALTERABILE

Grazie alla loro impermeabilità naturale e all'assenza di porosità, le superfici ceramiche vantano una velocità e facilità di pulizia superiore rispetto ad altri materiali. Inoltre, essendo il trattamento integrato in modo permanente, l'usura del pavimento non modifica le prestazioni antibatteriche della piastrella.

CONFORMITÀ BPR

La commercializzazione di **Bios Antibacterial®** è autorizzata e approvata dal Regolamento Europeo sui Biocidi (EU BPR 528/2012).



GUARDA IL VIDEO
(Bios Antibacterial®)



GUARDA IL VIDEO
(Bios Self-Cleaning®)

Ulteriori dettagli su www.biosceramics.it

bios.
ceramics

bios antibacterial®

BIOS CERAMICS®

Bios Ceramics® is the most advanced, exclusive generation of bioactive ceramics for certified, eco-compatible architectural applications, with antibacterial and self-cleaning properties and the ability to reduce pollutants.

The production is divided into two highly specialized treatments with continually improving performance:

Bios Self-Cleaning® and **Bios Antibacterial®**, able to respond to all kinds of requirements for applications indoors and outdoors, depending on the specific conditions of use.

In over 20 years of experimentation, this diversified offer, available across a variety of products, has made it possible to meet the creative requirements of designers and customers all over the world, thanks to the sophisticated finishes and the different formats available throughout the entire Casalgrande Padana product range.

BIOS SELF-CLEANING®

The **Bios Self-Cleaning®** treatment has been used for ventilated façades and cladding for over 14 years. Thanks to the special **Hydrotect® technology**, when the **Bios Self-Cleaning®** treatment comes into contact with sunlight, it triggers a reaction able to eliminate not only bacteria, but especially the pollutants in the air. It breaks

down dirt that has settled on the surface of the tiles, so that it can be removed by rainwater, thanks to the superhydrophilicity of the ceramic material.

BIOS ANTIBACTERIAL®

The **Bios Antibacterial®** treatment is able to give the ceramic surface antibacterial properties, using a silver ion technology that blocks the metabolism of bacteria.

The antibacterial feature Unlike the most common disinfectants, a bactericidal product such as **Bios Antibacterial®** is able to guarantee continual protection against these micro-organisms in three ways: it interrupts cell metabolism, blocks the processes of transport into the membrane and prevents the multiplication of the cells.

Following strict laboratory tests, **Bios Antibacterial®** proved capable of eliminating 99% of the four main strains of bacteria that are responsible for infections in hospital environments and have been adopted as the standard because they represent the most aggressive category, in some cases even resistant to antibiotics: *Staphylococcus aureus*, *Enterococcus faecalis*, *Escherichia coli* and *Pseudomonas aeruginosa*.

ALWAYS ACTIVE

The antibacterial treatment is

permanently integrated into the ceramic product and is always active, day and night, with or without sunlight, and does not require UV rays for activation.

ANTI-ODOUR AND ANTI-MOULD

In addition to its bactericidal capacity, **Bios Antibacterial®** prevents the formation of mould, yeast and fungi, the main culprits of unpleasant odours, thus making settings healthier and with a more pleasant smell.

EASY TO CLEAN AND UNALTERABLE

Because they are naturally impermeable and non-porous, ceramic surfaces are quicker and easier to clean than other materials. Furthermore, because the antibacterial treatment is permanently integrated into the ceramic product, the wear and tear of the flooring has no impact on the antibacterial performance of the tile.

BPR COMPLIANT

Bios Antibacterial® is authorized for sale and approved by the European Biocidal Products Regulation (EU BPR 528/2012).



WATCH THE VIDEO
(Bios Antibacterial®)



WATCH THE VIDEO
(Bios Self-Cleaning®)

Further details at www.biosceramics.com

bios.
ceramics

bios antibacterial®

BIOS CERAMICS®

Bios Ceramics® est la génération la plus avancée et la plus exclusive de céramiques bioactives pour des applications architecturales, certifiées et écocompatibles, offrant des caractéristiques antibactériennes, autonettoyantes et de réduction des agents polluants.

La production s'articule autour de deux traitements extrêmement spécialisés et soumis en permanence à des améliorations en termes de performances, **Bios Self-Cleaning®** et **Bios Antibacterial®**, capables de répondre à toute exigence d'application à l'intérieur comme à l'extérieur, en fonction des conditions d'utilisation spécifiques.

Il s'agit d'une proposition transversale et diversifiée qui, au cours de plus de vingt années d'expérimentations, a permis de satisfaire la créativité des concepteurs et des clients dans le monde entier. Et ce, grâce aux finitions raffinées et aux différents formats disponibles sur toute la gamme des produits de Casalgrande Padana.

BIOS SELF-CLEANING®

Depuis plus de 14 ans, le traitement **Bios Self-Cleaning®** est utilisé pour réaliser des revêtements de façade ainsi que des enveloppes ventilées. Grâce à la **technologie** spéciale

Hydrotect®, Bios Self-Cleaning®

déclenche, en présence de rayonnement solaire, une réaction capable d'éliminer non seulement les bactéries mais aussi et surtout les polluants présents dans l'air, de décomposer les saletés qui se déposent sur la surface des dalles et de les éliminer grâce à l'eau de pluie et aux propriétés superhydrophiles de la surface céramique.

BIOS ANTIBACTERIAL®

Le traitement **Bios Antibacterial®** est en mesure de donner des propriétés antibactériennes à la surface céramique, grâce à une technologie aux ions d'argent qui inhibe le métabolisme des bactéries.

LA FONCTION ANTIBACTÉRIENNE

Contrairement aux désinfectants couramment utilisés, un bactéricide comme **Bios Antibacterial®** est capable d'assurer une protection permanente contre les microorganismes en luttant contre les microbes des trois façons suivantes : il interrompt le métabolisme cellulaire, inhibe les processus de transport membranaire et empêche la multiplication des cellules.

À la suite de tests rigoureux menés en laboratoire, **Bios Antibacterial®** s'est révélé capable d'éliminer à 99% les quatre principales souches

bactériennes responsables des infections enregistrées en milieu hospitalier. Elles ont été adoptées comme référence car elles représentent la catégorie la plus agressive, et, dans certains cas, elles résistent également aux antibiotiques : *Staphylococcus aureus*, *Enterococcus faecalis*, *Escherichia coli* et *Pseudomonas aeruginosa*.

TOUJOURS ACTIF

Le traitement antibactérien est intégré de façon permanente dans le produit céramique et il est toujours actif, jour et nuit, avec ou sans rayonnement solaire, et, pour son activation, les rayons UV ne sont pas nécessaires.

ANTI-ODEURS ET ANTI-MOISSURE

En plus de son pouvoir bactéricide, **Bios Antibacterial®** évite l'apparition de moisissures, de levures et de champignons, principaux responsables des mauvaises odeurs, ce qui permet de rendre les espaces plus sains et plus agréables à l'odorat.

FACILE À NETTOYER ET INALTÉRABLE

Grâce à leur imperméabilité naturelle et à l'absence de porosité, les surfaces céramiques sont plus faciles et plus rapides à nettoyer que les autres matériaux. En plus, le traitement antibactérien étant intégré de façon permanente dans le produit céramique, l'usure du sol ne

modifie pas les prestations antibactériennes de la dalle.

CONFORMITÉ BPR

La commercialisation de **Bios Antibacterial®** est autorisée et approuvée par le Règlement européen sur les produits biocides (UE BPR 528/2012).



REGARDEZ LA VIDÉO
(Bios Antibacterial®)



REGARDEZ LA VIDÉO
(Bios Self-Cleaning®)

De plus amples détails sur le site www.biosceramics.com

bios.
ceramics

bios antibacterial®

BIOS CERAMICS®

Bios Ceramics® ist die modernste und exklusivste Generation bioaktiver Keramik für architektonische Anwendungen. Sie ist zertifiziert und umweltfreundlich und besitzt antibakterielle, selbstreinigende und schadstoffreduzierende Eigenschaften.

Die Produktreihe gliedert sich in zwei äußerst spezifische Behandlungen, die einer ständigen Leistungsverbesserung unterliegen: **Bios Self-Cleaning®** und **Bios Antibacterial®**, mit denen entsprechend den jeweiligen Einsatzbedingungen alle erforderlichen Anwendungen im Innen- und Außenbereich erfüllt werden können.

Dank der hochwertigen Oberflächenausführungen und der verschiedenen Größen, die für die gesamte Produktpalette von Casalgrande Padana zur Verfügung stehen, ist es in mehr als zwanzig Jahren des Experimentierens gelungen, mit dieser transversalen und vielfältigen Angebotspalette die Kreativität von Designern und Kunden auf der ganzen Welt zu befriedigen.

BIOS SELF-CLEANING®

Die **Behandlung Bios Self-Cleaning®** wird seit über 14 Jahren bei der Konstruktion von Außenfassadenverkleidungen und hinterlüfteten Gebäudehüllen eingesetzt. Dank der speziellen

Hydrotect®-Technologie

bindet **Bios Self-Cleaning®** bei Sonneneinstrahlung nicht nur Bakterien, sondern vor allem die in der Luft vorhandenen Schadstoffe, und zersetzt den auf der Fliesenoberfläche abgelagerten Schmutz. Die extrem hydrophile Keramikoberfläche sorgt dafür, dass der Schmutz durch das abfließende Regenwasser entfernt wird.

BIOS ANTIBACTERIAL®

Die Behandlung **Bios Antibacterial®** kann die antibakterielle Eigenschaften verleihen in das Keramikprodukt, wegen der Silberionentechnologie, die den Stoffwechsel von Bakterien blockiert.

DIE ANTIBAKTERIELLE WIRKUNG

Im Gegensatz zu herkömmlichen Desinfektionsmitteln ist ein Bakterizid wie **Bios Antibacterial®** in der Lage, einen kontinuierlichen Schutz vor Mikroorganismen zu bieten, indem es die Mikroben auf dreifache Weise bekämpft: Es unterbricht den Zellstoffwechsel, blockiert Transportprozesse in der Membran und verhindert die Zellvermehrung.

Im Rahmen strenger Labortests hat sich gezeigt, dass **Bios Antibacterial®** zu 99 % die vier wichtigsten Bakterienstämme abtöten kann,

die für Krankenhausinfektionen verantwortlich sind.

Diese Stämme wurden als Standard übernommen, da sie die aggressivste Kategorie darstellen und in einigen Fällen sogar resistent gegen Antibiotika sind: Staphylococcus aureus, Enterococcus faecalis, Escherichia coli und Pseudomonas aeruginosa.

IMMER AKTIV

Die antibakterielle Beschichtung ist dauerhaft in das Keramikprodukt integriert und immer aktiv, Tag und Nacht, mit oder ohne Sonnenlicht, und benötigt keine UV-Strahlen zur Aktivierung.

GERUCHSHEMMEND UND SCHIMMELHEMMEND

Zusätzlich zu seiner bakteriziden Wirkung verhindert **Bios Antibacterial®** die Bildung von Schimmel, Hefen und Pilzen, den Hauptverursachern schlechter Gerüche, und macht die Umgebung gesünder und angenehmer im Geruch.

LEICHT ZU REINIGEN UND UNVERÄNDERLICH

Dank ihrer natürlichen Undurchlässigkeit und Porenfreiheit lassen sich Keramikoberflächen schneller und einfacher reinigen als andere Materialien. Darüber hinaus da die antibakterielle Beschichtung dauerhaft in das Keramikprodukt integriert ist, ändert der Bodenverschleiß

die antibakterielle Wirkung der Fliese nicht.

BPR-KONFORMITÄT

Die Vermarktung von **Bios Antibacterial®** ist durch die europäische Biozid-Verordnung (EU BPR 528/2012) zugelassen und genehmigt.



DAS VIDEO ANSEHEN
(Bios Antibacterial®)



DAS VIDEO ANSEHEN
(Bios Self-Cleaning®)

Weiter Details auf der Website www.biosceramics.com

bios.
ceramics

Soluzioni personalizzate e assistenza tecnica

CUSTOM SOLUTIONS AND TECHNICAL SUPPORT
SOLUTIONS PERSONNALISEES ET ASSISTANCE TECHNIQUE
INDIVIDUELLE LÖSUNGEN UND TECHNISCHE UNTERSTÜTZUNG

La divisione Swimming Pool di Casalgrande Padana, oltre a proporre tecnologie e materiali ad alte prestazioni, è in grado di fornire alla propria clientela un servizio efficace ed efficiente per offrire al progettista una attiva assistenza per lo studio e lo sviluppo del progetto nelle sue varie fasi e gli strumenti per creare soluzioni personalizzate.

Una collaborazione che aiuta nell'orientamento tra i sistemi di finitura e nella valutazione dei prodotti Casalgrande Padana più idonei alle specifiche funzioni.

Besides providing high-performance technology and materials, Casalgrande Padana's Swimming Pool division provides customers with effective and efficient services in order to give designers active assistance during the project design and development phases as well as the tools to create custom solutions.

This collaboration helps moving among finishing systems and selecting the most suitable products in the Casalgrande Padana range.

En plus de proposer des technologies et des matières haut de gamme, la division Swimming Pool de Casalgrande Padana fournit à ses clients des services efficaces et efficaces pour offrir aux architectes une assistance active lors de l'étude, à la conception du projet dans ses différentes phases et de la création de solutions personnalisées.

Une collaboration efficace qui aide à s'orienter parmi les systèmes de finition et l'évaluation des produits Casalgrande Padana les plus adéquats pour des fonctions spécifiques.

Die Abteilung Swimming Pool von Casalgrande Padana bietet ihrer Kundschaft nicht nur hochwertige Technologien und Materialien, sondern auch einen wirksamen und effizienten Kundenservice, um dem Planer eine aktive Unterstützung beim Entwurf und bei der Entwicklung des Projektes in seinen verschiedenen Phasen zu leisten und ihm die Mittel zur Schaffung individueller Lösungen zur Verfügung zu stellen.

Diese Zusammenarbeit hilft bei der Orientierung zwischen den Ausführungssystemen und bei der Identifizierung der Produkte von Casalgrande Padana, die für die spezifischen Funktionen am besten geeignet sind.



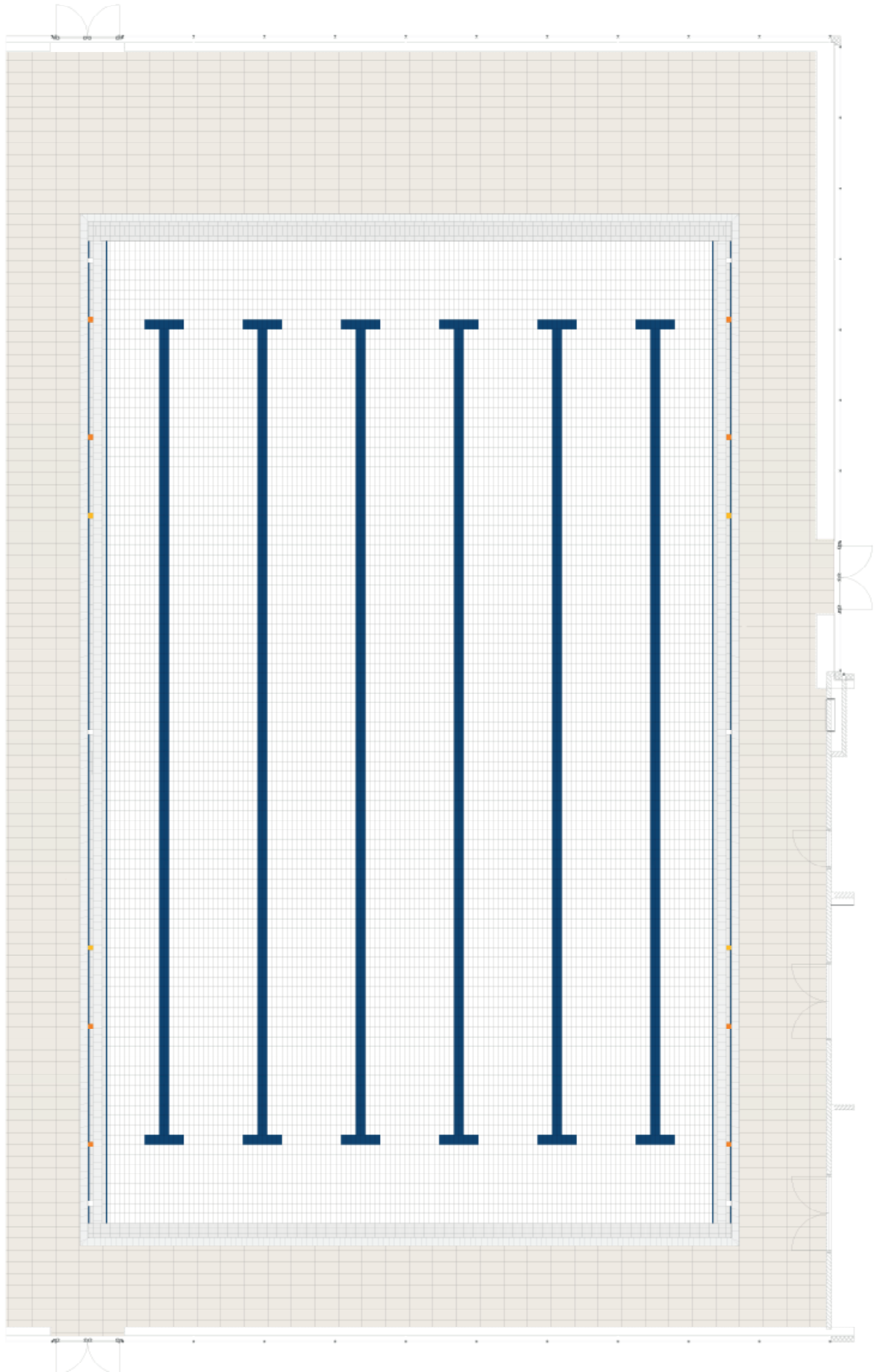

Sicurezza e norme antiscivolo

SAFETY AND NON-SLIP STANDARDS
SECURITE ET NORMES ANTIDERAPANTES
SICHERHEIT UND RUTSCHHEMUNGSNORMEN

La presenza di superfici asciutte, bagnate o addirittura completamente immerse nell'acqua rende indispensabile l'utilizzo di materiali con specifiche caratteristiche antiscivolo. Tutte la gamme di prodotti illustrate in questo catalogo includono diverse tipologie di superfici in modo da poter essere impiegate nei diversi ambienti per evitare qualsiasi rischio di caduta.

Le piastrelle in gres porcellanato, sia nella versione smaltata che non smaltata, diventano quindi pavimentazioni affidabili sotto il profilo della sicurezza antiscivolo e pratiche sotto l'aspetto della facilità di pulizia e dell'igiene.

Le normative più idonee a valutare la resistenza alla scivolosità a piedi nudi sono la norma tedesca DIN 51097 e quella francese più recente XP P 05-010.

Nel caso di aree e superfici generalmente bagnate è importante anche poter valutare la capacità drenante dei pavimenti per evitare inutili ristagni d'acqua e prevenire fenomeni di aquaplaning.

La norma DIN 51130 è in grado di determinare, oltre alla valutazione della scivolosità a piedi calzati, anche il coefficiente di drenaggio "V" delle superfici ceramiche.

Entrambe le norme prevedono poi una classificazione dei vari tipi di locali ai quali attribuiscono i necessari valori antiscivolo.

The presence of dry, wet or even completely submerged surfaces makes it essential to use specifically anti-slip materials.

All product ranges described in this section include different types of surfaces, for use in different contexts to prevent any risk of falling.

Porcelain tiles, either in the glazed or unglazed version, stand as reliable flooring material in terms of slip resistance and ease of maintenance and cleaning.

The most appropriate standards to assess barefoot anti-slip performance are German DIN 51097 and the latest French XP P 05-010.

For generally wet areas it is also important to assess drainage capacity in order to prevent unnecessary accumulations of water and prevent aquaplaning.

In this respect, the standard DIN 51130 can also measure the "V" drainage coefficient of ceramic surfaces.

In addition, both standards provide a classification of different types of premises, to which they attribute the relevant non-slip performance values.

La présence de surfaces sèches, humides ou même totalement plongées dans l'eau rend indispensable l'emploi de matériaux avec des caractéristiques antidérapantes spécifiques. Toutes les gammes des produits décrites dans ce catalogue comprennent de différentes typologies de surfaces, en mesure d'être utilisées dans plusieurs contextes pour éviter les risques de chute.

Les carreaux en grès cérame, dans leur version émaillée ou non, s'avèrent alors des revêtements de sol fiables sur le plan de la résistance antidérapante et pratiques en ce qui concerne l'entretien et le nettoyage.

Les normes les plus adéquates pour évaluer la résistance à la glissance mesurée pieds nus sont la norme allemande DIN 51097 et celle française XP P 05-010, plus récente.

En cas de zones et surfaces généralement humides, il faut également évaluer la capacité de drainage des revêtements de sol pour éviter des accumulations d'eau inutiles et prévenir les phénomènes d'aquaplaning.

A cet égard, la norme DIN 51130 peut mesurer non seulement l'évaluation de la glissance pieds chaussés mais aussi le coefficient de drainage "V" des surfaces céramiques.

En outre, les deux normes prévoient une classification des différents types de locaux auxquels sont attribuées les valeurs antidérapantes nécessaires.

Das Vorhandensein trockener, feuchter oder auch vollkommen mit Wasser bedeckter Oberflächen macht eine Verwendung von Materialien mit spezifischen rutschfesten Eigenschaften unerlässlich.

Alle in diesem Katalog illustrierten Produktsortimente beinhalten verschiedene Oberflächenausführungen zur Verwendung in den unterschiedlichen Umgebungen, um ein jegliches Fallrisiko zu vermeiden.

Die Feinsteinzeugfliesen werden somit sowohl in glasierter als auch in unglasierter Version zu einem in Bezug auf die Rutschsicherheit zuverlässigen und hinsichtlich einer einfachen Reinigung und Hygiene praktischen Fußbodenbelag.





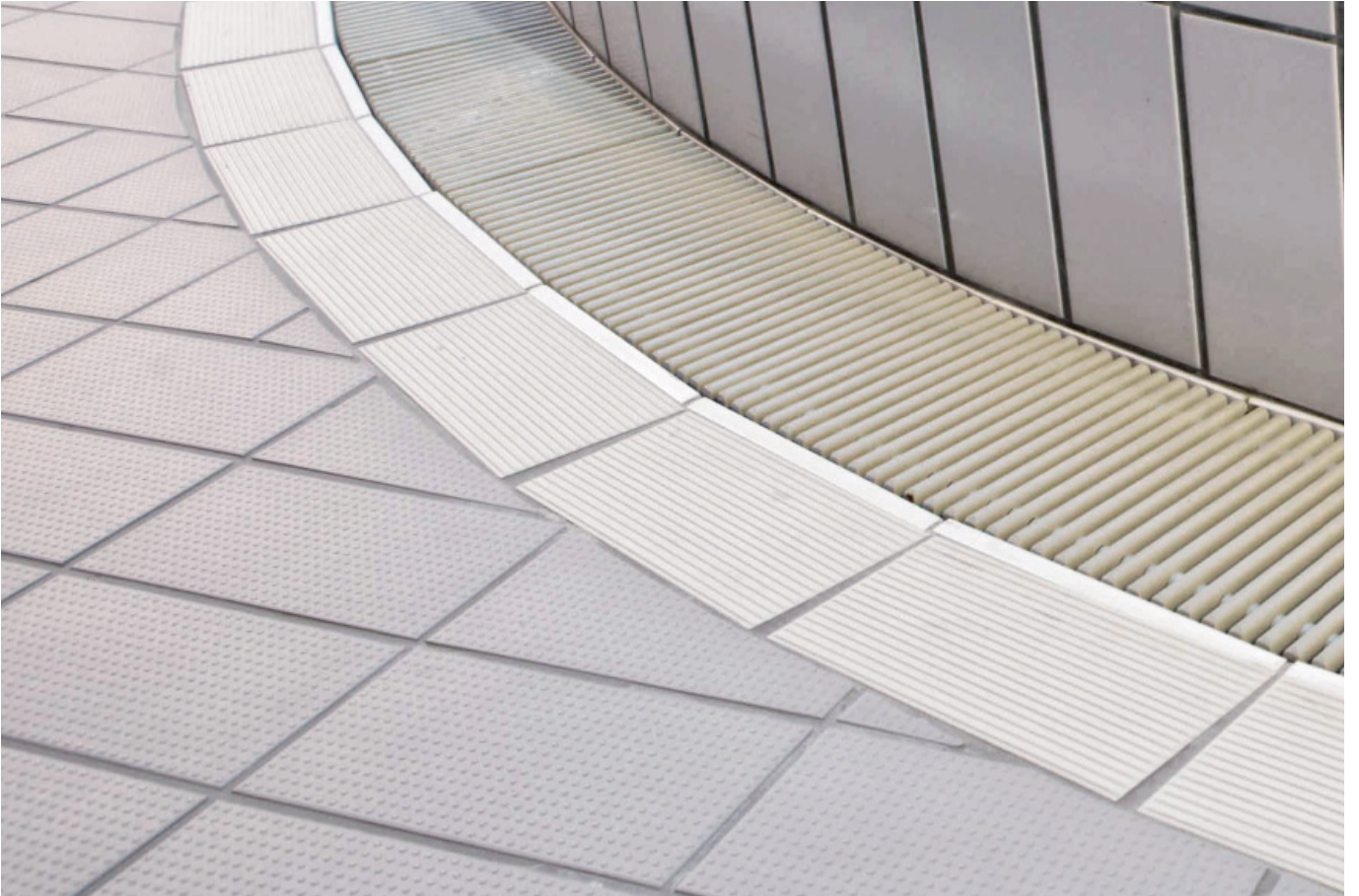

Die Richtlinien, die sich zur Bestimmung der Rutschfestigkeit bei Betreten mit bloßen Füßen am besten eignen, sind die deutsche Norm DIN 51097 und die aktuellere französische Norm XP P 05-010.

Im Fall von üblicherweise feuchten Oberflächen, muss auch die Sicherleistung der Böden bewertet werden können, um unnütze Wasseranstauungen oder Aquaplaning-Phänomene zu vermeiden.











Die Norm DIN 51130 ist in der Lage nebst der Bewertung der Rutschsicherheit beim Begehen mit Schuhwerk auch den Dränkoeffizienten "V" der Keramikoberflächen zu bestimmen.



Beide Normen sehen außerdem eine Klassifizierung der verschiedenen Räumlichkeiten vor, denen die jeweils erforderlichen Rutschsicherheitswerte zugeordnet werden.



XP P 05-011		DIN 51097				
Valore piedi nudi Barefoot value Valeur pieds nus Barfußwert	Zone d'impiego Deployment areas Classement locaux Einsatzbereiche	Valore piedi nudi Barefoot value Valeur pieds nus Barfußwert	Zone d'impiego Deployment areas Classement locaux Einsatzbereiche			
PN 12 $12^\circ \leq \alpha < 18^\circ$ 	4.2.5 Piscine Vestiaires (zones sèches) Couloirs, escaliers (zones sèches) WC (zone sèches) 4.2.6 Thermalisme Sauna Salle de massage	A $\geq 12^\circ$ 	Corridoi percorribili a piedi nudi (prevalentemente asciutti)	Barefoot passages (nearly dry)	Couloirs à fréquentation pieds nus (souvent secs)	Barfußgänge (weitgehend trocken)
			Spogliatoi singoli e collettivi	Individual and common dressing rooms	Vestiaires individuels et collectifs	Einzel- und Sammelumkleideräume
			Fondo vasca nei settori per non nuotatori (se la profondità dell'acqua nell'intero settore misura più di 80 cm)	Pool floors in non-swimmer areas if the water depth is more than 80 cm in the entire area	Fonds de bassin pour non-nageurs si la profondeur d'eau n'est jamais inférieure à 80 cm.	Beckenböden in Nichtschwimmerbereichen, wenn im gesamten Bereich die Wassertiefe mehr als 80 cm beträgt
			Zone sauna e di riposo (prevalentemente asciutte)	Sauna and relaxation areas (nearly dry)	Les saunas et zones de repos (souvent secs)	Sauna- und Ruhebereiche (weitgehend trocken)
PN 18 $18^\circ \leq \alpha < 24^\circ$ 	4.2.5 Piscine Pataugeoires ou sol de bassin non nageur de profondeur inférieure à 80 cm Sol de bassin nageur de profondeur inférieure à 150 cm Plages (pente maxi de 5%) Gradins Locaux attenants aux plages Couloirs, escaliers (zones humides) Douches Vestiaires (zones humides) WC (zones humides) 4.2.6 Thermalisme Hammam, bain turc Local d'application de boues, d'algues Local de douches à jets Local de jets filaires Vaporarium Local de balnéothérapie	B $\geq 18^\circ$ 	Corridoi percorribili a piedi nudi, se non classificati nel gruppo A	Barefoot passages, if not classified in group A	Couloirs à fréquentation pieds nus autres que groupe A	Barfußgänge, soweit sie nicht A zugeordnet sind
			Docce	Showers	Salles de douches	Duschräume
			Area getti di disinfezione	Area of disinfecting spray facilities	Voisinage des pulvérisateurs de désinfectant	Bereich von Desinfektionssprühanlagen
			Aree circostanti la vasca	Pool surrounds	Plages de bassins	Beckenumgänge
			Fondo vasca nei settori per non nuotatori se la profondità dell'acqua è inferiore in alcuni punti a 80 cm	Pool floors in non-swimmer areas if the water depth is less than 80 cm in certain areas	Fonds de bassins pour non-nageurs quand la profondeur peut être inférieure à 80 cm	Beckenböden in Nichtschwimmerbereichen, wenn in Teilbereichen die Wassertiefe weniger als 80 cm beträgt
			Fondo vasca nei settori per non nuotatori in piscine con onde artificiali	Non-swimmer sections of wave-action pools	Fonds de bassins – zone « non-nageurs » – de piscines à vagues artificielles	Beckenböden in Nichtschwimmerbereichen von Wellenbecken
			Fondo vasca regolabile in altezza	Movable floors	Sols éleveurs	Hubböden
			Vasche per bambini	Paddling pools	Bassins d'enfants	Planschbecken
			Scale e gradini all'esterno della vasca	Ladders and stairs outside the pool area	Echelles et escaliers situés hors du voisinage du bassin	Leitern und Treppen außerhalb des Beckenbereiches
			Zone sauna e di riposo, se non classificate nel gruppo a	Sauna and relaxation areas, if not classified in group A	Saunas et zones de repos, sauf ceux affectés à la catégorie A	Sauna- und Ruhebereiche, soweit sie nicht A zugeordnet sind
PN 24 $\alpha \geq 24$ 	4.2.5 Piscine Pédiluves Margelles Plots Escaliers d'accès à l'eau Rampes d'accès à l'eau Bordures de bassin immergées Quais de départ	C $\geq 24^\circ$ 	Gradini e scale di entrata in acqua	Ladders and stairs leading into the water	Echelles et escaliers d'entrée dans l'eau	Ins Wasser führende Leitern und Treppen
			Salite a trampolini e acquascivoli	Stairs up to diving facilities and water slides	Echelles d'accès aux plongeurs et toboggans aquatiques	Aufgänge zu Sprunganlagen und Wasserrutschen
			Vasche lavapiedi	Walk-through pools	Pédiluves	Durchschreitebecken
			Bordovasca inclinato	Inclined pool edges	Bords de bassin inclinés	Geeigte Beckenrandausbildungen

SPORT&FUN		WELLNESS&SPA		
GRESPLUS	GRANITOGRES	PIETRE NATIVE		GRANITOKER
LANDSCAPE	ELEMENTI	MINERAL CHROM	AMAZZONIA	NEWOOD
Satin			Naturale	
Friction	Matt	Naturale		
Grip Rigata	Pinhead Roccia Rigata		Grip	Outdoor

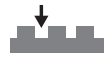
XP P 05-010		DIN 51130		SPORT&FUN		WELLNESS&SPA		
				GRESPLUS	GRANITOGRES	PIETRE NATIVE		GRANITOKER
				LANDSCAPE	ELEMENTI	MINERAL CHROM	AMAZZONIA	NEWOOD
Valore piedi calzati Shoed value Valeur pieds chaussés Bewertungsgruppen								
PC6 6° ≤ α < 10° 	R9 > 6° - 10° 							
PC 10 10° ≤ α < 20° 	R10 > 10° - 19° 			Matt	Soft	Naturale	Naturale	
PC 20 20° ≤ α < 27° 	R11 > 19° - 27° 			Pinhead	Naturale			Outdoor
PC 27 27° ≤ α < 35° 	R12 > 27° - 35° 			Roccia Rigata		Grip		
PC 35 α ≥ 35° 	R13 > 35° 							

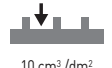
DIN 51130		SPORT&FUN		WELLNESS&SPA		
		GRESPLUS	GRANITOGRES	PIETRE NATIVE		GRANITOKER
		LANDSCAPE	ELEMENTI	MINERAL CHROM	AMAZZONIA	NEWOOD
Volume di drenaggio Drainage volume Volume de drenage Verdrängungsraum						
V4	 4 cm³ /dm²					
V6	 6 cm³ /dm²		Pinhead			Outdoor
V8	 8 cm³ /dm²	Rigata	Rigata			
V10	 10 cm³ /dm²					

Percorsi per le disabilità visive

PATHS FOR VISUALLY DISABLED PEOPLE
PARCOURS POUR MALVOYANTS ET AVEUGLES
LEITWEGE FÜR SEHBEHINDERTE

Casalgrande Padana, da sempre sensibile ai problemi sociali e delle disabilità, ha sviluppato e realizzato il progetto Granitogres Tactile, un vero e proprio insieme di codici a rilievo impressi direttamente sulle ceramiche in gres porcellanato che consente la realizzazione di percorsi tattili completi e capaci di offrire una maggiore autonomia negli spostamenti dei non vedenti e ipovedenti negli edifici pubblici e in ambito urbano in genere.

Per ulteriori dettagli vedi catalogo Granitogres Tactile.

Casalgrande Padana has always been sensitive to social problems and disabilities. For this reason, it has developed and created the Granitogres Tactile project, a set of embossed codes printed directly on the porcelain tiles for the development of comprehensive tactile paths offering greater autonomy to the visually impaired and blind in public buildings and urban settings in general.

For further details see the Granitogres Tactile catalogue.

Casalgrande Padana, toujours sensible aux problèmes sociaux et aux incapacités, a développé et créé le projet Granitogres Tactile, un véritable ensemble de codes en relief, imprimés directement sur les carreaux en grès cérame, pour la création de parcours tactiles complets, en mesure d'offrir une plus grande autonomie aux malvoyants et non-voyants dans les bâtiments publics et dans l'environnement urbain en général.

Pour plus détails voir catalogue Granitogres Tactile.

Casalgrande Padana widmet seit jeher den sozialen Problemen und den Behinderungen eine besondere Aufmerksamkeit und hat nunmehr das Projekt Granitogres Tactile entwickelt und umgesetzt. Es handelt sich um einen direkt in das Feinsteinzeug eingepprägten Blinddruck, der die Verwirklichung von kompletten taktilen Leitwegen ermöglicht, die den Blinden und Sehbehinderten zu einer größeren Autonomie bei der Fortbewegung in den öffentlichen Gebäuden und im städtischen Milieu im Allgemeinen verhelfen können.

Für Details siehe Katalog Granitogres Tactile.





SPORT & FUN

PIASTRELLE E PEZZI SPECIALI SPECIFICI PER PISCINE E IMPIANTI NATATORI

CERAMIC TILES AND FITTINGS
FOR SWIMMING POOLS AND AQUATIC CENTERS

CARREAUX ET PIECES SPECIALES
POUR PISCINES ET CENTRES AQUATIQUES

FLIESEN UND FORMSTÜCKE
FUER SCHWIMMBÄDERN UND SCHWIMMANLAGEN

Landscape

GRESPLUS

piastrelle in gres porcellanato smaltato

GLAZED PORCELAIN TILES
CARREAUX EN GRES CERAME EMAILLE
GLASIERTE FEINSTEINZEUGFLIESEN

La serie Landscape unisce le valenze tecniche del gres porcellanato alle peculiarità estetiche e alle cromie offerte dagli smalti ceramici.

Studiata espressamente per gli interni delle vasche è comunque adatta, con la superficie Satin, anche per rivestimenti murali in genere.

Landscape Series combines the technical standards of porcelain stoneware and the aesthetic features and colours of ceramic glazes.

Specially designed for pool tanks, Landscape is also commonly used for wall cladding in general, in the Satin surface version.

La série Landscape réunit les valeurs techniques du grès cérame et les caractéristiques esthétiques et les tons des émaux céramiques.

Spécialement conçue pour les revêtements intérieurs des bassins, Landscape est néanmoins indiquée pour les revêtements muraux en général, grâce à la surface Satin.

Landscape verbindet die technischen Werte des Feinsteinzeugs mit den ästhetischen Besonderheiten und den Farbtönen der Keramikglasuren.

Das eigens für den Beckeninnenraum entwickelte Landscape eignet sich mit seine Satin Oberfläche auch für allgemeine Wandverkleidungen.

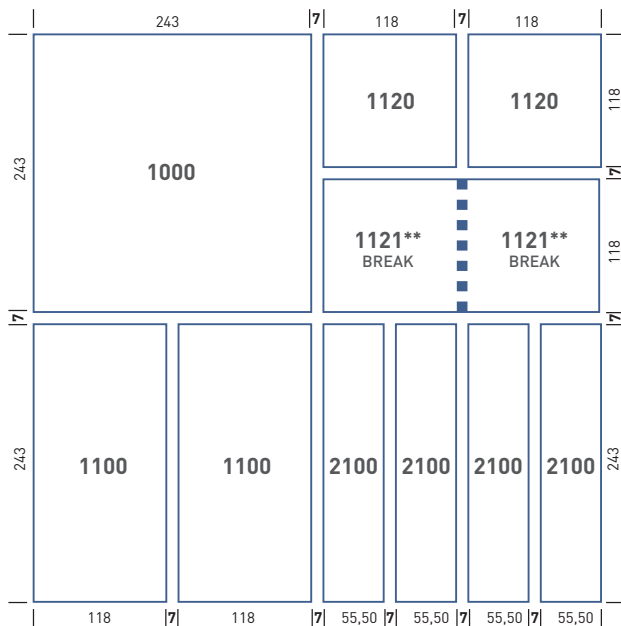

Codice formato Ref. format Format code Format Nr.	Misure di fabbricazione*** Cotes de fabrication Worksizes Herstellmasse	Misure nominali Cotes nominales Nominal sizes Nennmasse
1000	243x243 mm 9 ⁹ / ₁₆ " x 9 ⁹ / ₁₆ "	M*25x25 cm M*9 ⁷ / ₈ " x 9 ⁷ / ₈ "
1120	118x118 mm 4 ⁵ / ₈ " x 4 ⁵ / ₈ "	M*12,5x12,5 cm M*4 ⁷ / ₈ " x 4 ⁷ / ₈ "
1121** BREAK	118x118 mm x 2 pc 4 ⁵ / ₈ " x 4 ⁵ / ₈ " x 2pc	M*12,5x12,5 cm x 2 pc M*4 ⁷ / ₈ " x 4 ⁷ / ₈ " x 2 pc
1100	118x243 mm 4 ⁵ / ₈ " x 9 ⁹ / ₁₆ "	M*12,5x25 cm M*4 ⁷ / ₈ " x 9 ⁷ / ₈ "
2100	55,5x243 mm 2 ³ / ₁₆ " x 9 ⁹ / ₁₆ "	M*6,25x25 cm M*2 ¹ / ₂ " x 9 ⁷ / ₈ "

* M = formato modulare modular size format modulaire modulformat

Importante: La modularità dei formati si ottiene con fuga di 7 mm
Important: Modularity of different sizes is based on 7 mm grouting joints.

Important: La modularité des formats est calculée avec un joint de 7 mm
Wichtig: Für Modulverlegung die empfohlene Fugenbreite ist 7 mm

** Da separare in cantiere To break on job site À séparer en chantier
Spaltplatten auf Baustelle zubereiten

*** Calibro 0 Caliber 0 Pige 0 Kaliber 0

piastrelle in gres porcellanato smaltato / glazed porcelain tiles /
carreaux en grés cérame émaillé / glasierte Feinsteinzeugfliesen

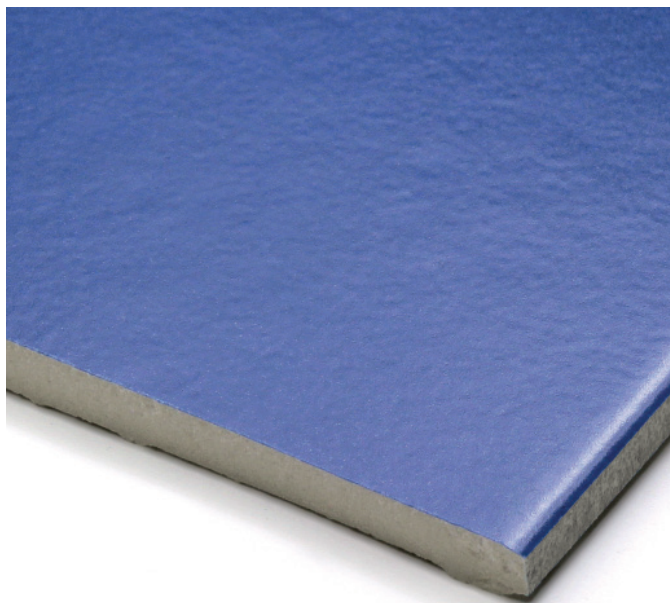

Landscape - GRESPLUS

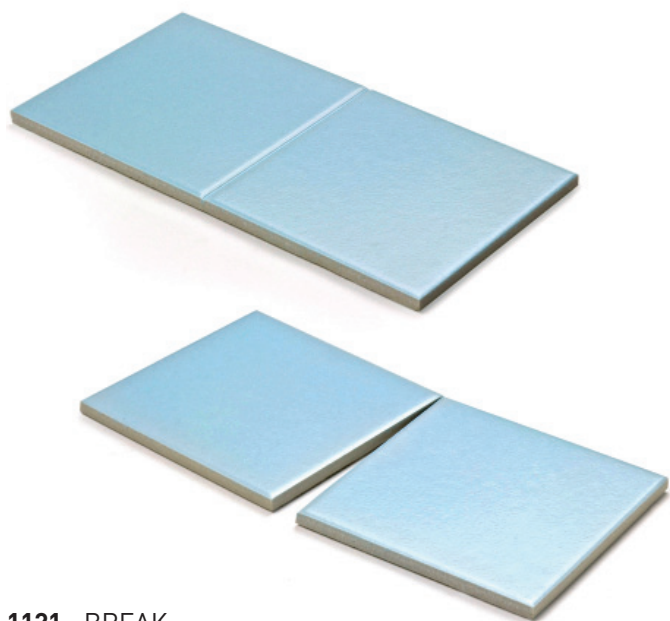

1121 - BREAK



ESEMPIO CODIFICA PRODOTTI EXAMPLE PRODUCTS CODING EXAMPLE DE CODIFICATION DES PRODUITS BEISPIEL CODIERUNG DER PRODUKTE

Codice Code Code Kode	Codice formato o sagoma prodotto Code for size or shape of the product Code du format ou forme du produit Kode des Format oder Stückform des Artikels	Codice colore Colour code Code de la couleur Farbkode	Tipo di superficie Surface type Type de surface Oberflächenart
1100 202G	1100 = M12,5x25 cm / M4 ^{7/8} " x 9 ^{7/8} "	202 = Ocean	G = Grip
1106 200S	1106 = Pezzo speciale / Fitting / Pièce spéciale / Formstück	200 = Bay	S = Satin

Landscape

GRESPLUS superfici

SURFACES
SURFACES
OBERFLÄCHEN

Satin = S

È realizzata con smalti semi-lucidi che offrono una maggior resistenza all'abrasione anche se resta scivolosa se bagnata. Risulta pertanto adatta per rivestire pareti e fondo di vasche e per realizzare rivestimenti murali.

This surface is made with semi-gloss enamels that provide a higher resistance to abrasion. It is especially suitable for cladding walls and deep bottoms of pools and for other wall applications.

Cette surface est réalisée avec des émaux semi-brillants qui offrent une résistance à l'abrasion plus élevée ; elle se maintient toutefois glissante si mouillée. Spécialement indiquée pour les revêtements des parois et des fonds supérieurs à 1.5 m des bassins et pour les revêtements muraux.

Es handelt sich um Oberfläche mit mattglänzenden Glasuren, die eine höhere Abriebfestigkeit aufweisen, jedoch in feuchtem Zustand rutschig bleiben. Satin eignet sich daher zur Verkleidung der Schwimmbeckenwände- und böden sowie für Wandverkleidungen.

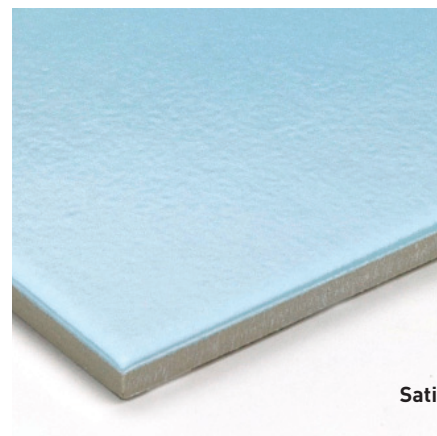

Satin

DIN 51097 XP P 05-010
A PN 12



Friction = F

Superficie semi-opaca ruvida ma non strutturata, con un grado di antiscivolosità di gruppo B a piedi nudi.

Consigliata per fondi vasca di piscine per bambini, per vasche a profondità limitata, per le zone di virata nelle piscine sportive e per sdrai e sedute di panche immerse in acqua.

Rough semi-matt but unstructured surface, with a Group B barefoot anti-slip degree. Recommended for children pool bottoms, limited depth pool, turning areas in competition pools and underwater benches.

Surface semi-mate rugueuse mais non structurée, avec un degré anti-glissance pieds nus de groupe B.

Recommandée pour les fonds des pataugeoires, les bassins à profondeur limitée, les zones de virage dans les piscines sportives et les banquettes plongées dans l'eau.

Es handelt sich um eine raue, aber nicht strukturierte halbmatte Oberfläche der Rutschfestigkeitsklasse B bei barfüßigem Betreten. Sie wird für die Böden von Kinderschwimmbecken, für Schwimmbecken mit geringer Tiefe, für Wendebereiche von Sportschwimmbecken und für unter Wasser positionierte Liegen und Sitzbänke empfohlen.

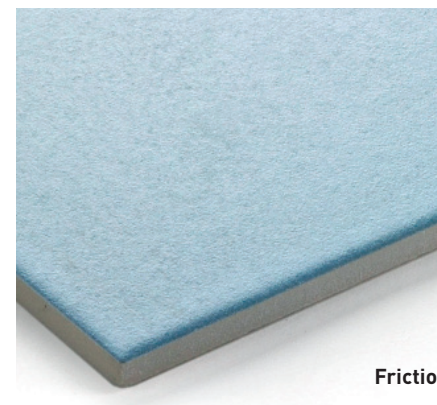

Friction

DIN 51097 XP P 05-010
B PN 18



Grip = G

È una superficie opaca e non strutturata con una rugosità più evidente per garantire un grado di antiscivolosità di gruppo C a piedi nudi. Può essere usata per bordi vasca, scale e gradini immersi in acqua, vasche lavapiedi e piani inclinati con forti pendenze.

It is a matt, unstructured surface with greater roughness degree to ensure group C barefoot non-slip degree. Recommended for pool borders, underwater stairs and steps, feet washers and ramps.

Surface rugueuse et non structurée avec rugosité plus marquée pour garantir un degré anti-glissance pieds nus de groupe C. Recommandée pour têtes de bassin, escaliers et marches plongés dans l'eau, pédiluves et plans inclinés à forte pente.

Es handelt sich um eine matte und unstrukturierte Oberfläche mit einer stärkeren Oberflächenrauheit zur Gewährleistung der Rutschfestigkeitsklasse C bei barfüßigem Betreten. Sie kann für Beckenränder, unter Wasser positionierte Treppen und Stufen, Durchschreitbecken und schräge Flächen mit einer starken Neigung verwendet werden.

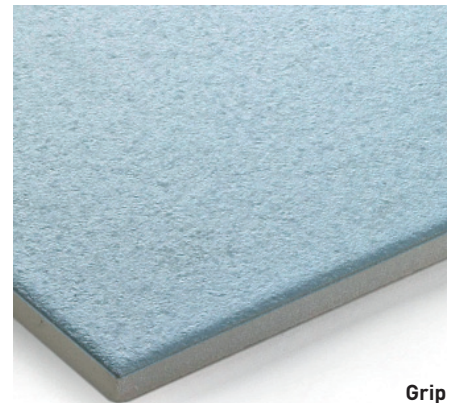

Grip

DIN 51097
C

XP P 05-010
PN 24



Rigata-Cannelé = C

Dedicata ai pezzi speciali 3200 e 3220 (vedi pag. 49), questa superficie é caratterizzata da righe in rilievo da posare trasversalmente al senso di marcia per poter beneficiare di un grado di antiscivolosità di gruppo C a piedi nudi. Ha gli stessi campi di applicazione della superficie Grip, ma con caratteristiche estetiche diverse.

This surface is focused on the special fittings 3200 and 3220 (see page 49) and it is characterized by relief grooves to be arranged crosswise to traffic direction in order to ensure a Group C barefoot non-slip degree. The performance is equivalent to the Grip surface but with different aesthetic features.

Cette surface est destinée aux pièces spéciales 3200 et 3220 (voir pag. 49), étant caractérisée par des cannelures en relief à poser transversalement au sens de marche pour bénéficier d'un degré anti-glissance pieds nus de groupe C. Ses champs d'application équivalent à ceux de la surface Grip, mais avec des caractéristiques esthétiques différentes.

Diese Oberfläche ist für die Formstücke 3200 und 3220 (siehe Seite 49) bestimmt und ist durch quer zur Laufrichtung zu verlegende Reliefstreifen gekennzeichnet, die die Rutschfestigkeitsklasse C bei barfusigem Betreten gewährleisten. Sie hat dieselben Anwendungsbereiche der Oberfläche Grip, jedoch mit unterschiedlichen ästhetischen Merkmalen.

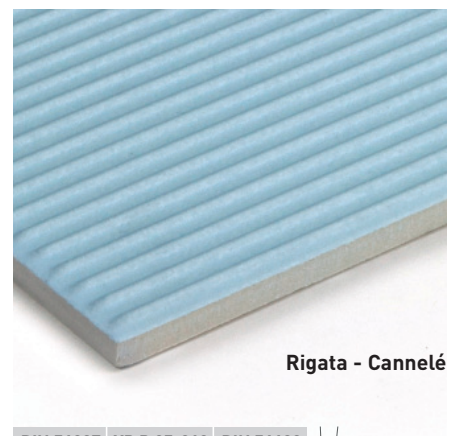

Rigata - Cannelé

DIN 51097
C

XP P 05-010
PN 24

DIN 51130
V 8



LANDSCAPE

Gruppo B1a

8 mm

Tundra 100



Satin	
1100 100S	M12,5x25 cm / M4 ^{7/8} "x9 ^{7/8} "
1000 100S	M25x25 cm / M9 ^{7/8} "x9 ^{7/8} "
1120 100S	M12,5x12,5 cm / M4 ^{7/8} "x4 ^{7/8} "
1121 100S	M12,5x12,5 cm x2 pc / M4 ^{7/8} "x4 ^{7/8} " x2 pc
2100 100S	M6,25x25 cm / M2 ^{1/2} "x9 ^{7/8} "

Friction	
1100 100F	M12,5x25 cm / M4 ^{7/8} "x9 ^{7/8} "
1000 100F	M25x25 cm / M9 ^{7/8} "x9 ^{7/8} "
1120 100F	M12,5x12,5 cm / M4 ^{7/8} "x4 ^{7/8} "
1121 100F	M12,5x12,5 cm x2 pc / M4 ^{7/8} "x4 ^{7/8} " x2 pc

Grip	
1100 100G	M12,5x25 cm / M4 ^{7/8} "x9 ^{7/8} "
1000 100G	M25x25 cm / M9 ^{7/8} "x9 ^{7/8} "
1120 100G	M12,5x12,5 cm / M4 ^{7/8} "x4 ^{7/8} "

Beach 101



Satin	
1100 101S	M12,5x25 cm / M4 ^{7/8} "x9 ^{7/8} "

Friction	
1100 101F	M12,5x25 cm / M4 ^{7/8} "x9 ^{7/8} "

Artic 701

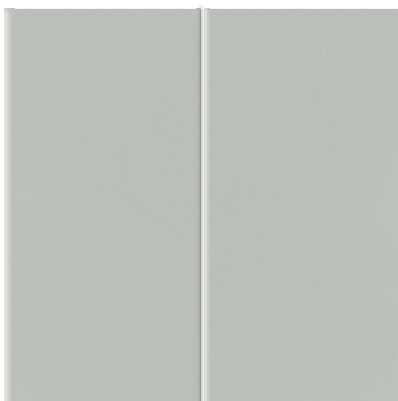

Satin	
1100 701S	M12,5x25 cm / M4 ^{7/8} "x9 ^{7/8} "

Friction	
1100 701F	M12,5x25 cm / M4 ^{7/8} "x9 ^{7/8} "

Bay 200

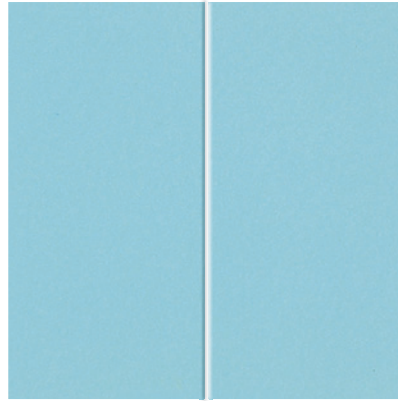

Satin	
1100 200S	M12,5x25 cm / M4 ^{7/8} "x9 ^{7/8} "
1120 200S	M12,5x12,5 cm / M4 ^{7/8} "x4 ^{7/8} "
1121 200S	M12,5x12,5 cm x2 pc / M4 ^{7/8} "x4 ^{7/8} " x2 pc
2100 200S	M6,25x25 cm / M2 ^{1/2} "x9 ^{7/8} "

Friction	
1100 200F	M12,5x25 cm / M4 ^{7/8} "x9 ^{7/8} "
1120 200F	M12,5x12,5 cm / M4 ^{7/8} "x4 ^{7/8} "
1121 200F	M12,5x12,5 cm x2 pc / M5"x5" x2 pc

Grip	
1100 200G	M12,5x25 cm / M4 ^{7/8} "x9 ^{7/8} "
1120 200G	M12,5x12,5 cm x2 pc / M4 ^{7/8} "x4 ^{7/8} " x2 pc

Bahama 501

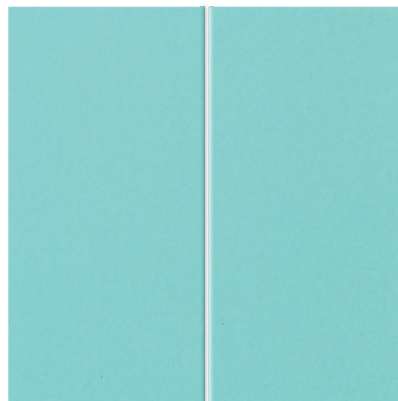

Satin	
1100 501S	M12,5x25 cm / M4 ^{7/8} "x9 ^{7/8} "

Friction	
1100 501F	M12,5x25 cm / M4 ^{7/8} "x9 ^{7/8} "

Grip	
1100 501G	M12,5x25 cm / M4 ^{7/8} "x9 ^{7/8} "

Ocean 202

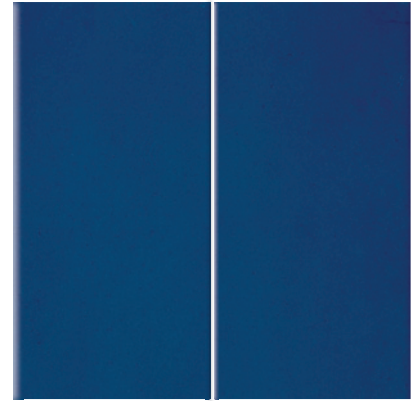

Satin	
1100 202S	M12,5x25 cm / M4 ^{7/8} "x9 ^{7/8} "
1120 202S	M12,5x12,5 cm / M4 ^{7/8} "x4 ^{7/8} "
1121 202S	M12,5x12,5 cm x2 pc / M4 ^{7/8} "x4 ^{7/8} " x2 pc
2100 202S	M6,25x25 cm / M2 ^{1/2} "x9 ^{7/8} "

Friction	
1100 202F	M12,5x25 cm / M4 ^{7/8} "x9 ^{7/8} "
1120 202F	M12,5x12,5 cm / M4 ^{7/8} "x4 ^{7/8} "
1121 202F	M12,5x12,5 cm x2 pc / M4 ^{7/8} "x4 ^{7/8} " x2 pc

Grip	
1100 202G	M12,5x25 cm / M4 ^{7/8} "x9 ^{7/8} "
1120 202G	M12,5x12,5 cm x2 pc / M4 ^{7/8} "x4 ^{7/8} " x2 pc















































Lava 700



Satin	
1100 700S	M12,5x25 cm / M4 ^{7/8} "x9 ^{7/8} "

Friction	
1100 700F	M12,5x25 cm / M4 ^{7/8} "x9 ^{7/8} "

Grip	
1100 700G	M12,5x25 cm / M4 ^{7/8} "x9 ^{7/8} "

					
	1120	1121 break**	2100	1100	1000
Formati Sizes Formats Formate	cm M* 12,5x12,5 4 ⁷ / ₈ "x4 ⁷ / ₈ "	cm M* 12,5x12,5 2 pc 4 ⁷ / ₈ "x4 ⁷ / ₈ "	cm M* 6,25x25 2 ¹ / ₂ "x9 ⁷ / ₈ "	cm M* 12,5x25 cm 4 ⁷ / ₈ "x9 ⁷ / ₈ "	cm M* 25x25 9 ⁷ / ₈ "x9 ⁷ / ₈ "
Tundra 100	  	 		  	  
Bay 200	  	 		  	
Ocean 202	  	 		  	
Beach 101				 	
Bahama 501				  	
Lava 700				  	
Artic 701				 	
	mm 8	mm 8	mm 8	mm 8	mm 8

● Satin

● Friction

● Grip

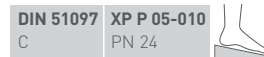
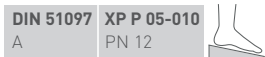









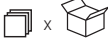





* M = formato modulare modular size format modulaire modulformat

** Da separare in cantiere To break on job site À séparer en chantier Spaltplatten auf Baustelle zuberechen

Caratteristiche tecniche a pagina: Technical features on page: Caractéristiques techniques à la page: Technische Eigenschaften auf Seite: 234

PESI, MISURE E CONTENUTO DEI COLLI WEIGHT, SIZE AND CONTENTS OF THE PACKING
POIDS, DIMENSIONS, CONTENU DES COLIS VERPACKUNGSRÖSSEN/GEWICHTE

Formati Sizes Format Format	 x 		 x 	 x 	 x 	 x 	 x 	 x 
	Satin	Friction	Grip					
1120 M12,5x12,5	Satin	64	64	1,00	72	72,00	17,00	1224,00
	Friction	64						
	Grip	64						
1121 M12,5x12,5 x2 pc	Satin	32 x2	64	1,00	78	78,00	17,00	1326,00
	Friction	32 x2						
2100 M6,25x25	Satin	64	64	1,00	72	72,00	17,00	1224,00
1100 M12,5x25	Satin	32	32	1,00	78	78,00	17,00	1326,00
	Friction	32						
	Grip	32						
1000 M25x25	Satin	16	16	1,00	78	78,00	17,00	1326,00
	Friction							
	Grip							

LANDSCAPE

MOSAICI

8 mm

FORMATI SIZES FORMATS FORMAT

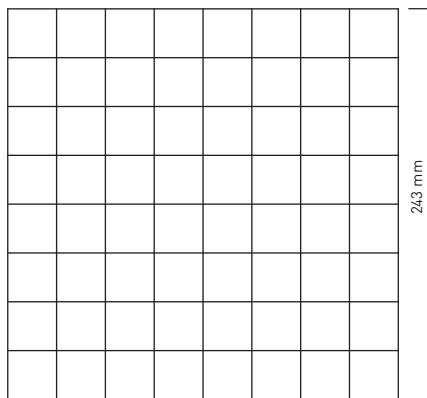

2,9x2,9 cm / 1 1/8"x1 1/8"
M 25x25 cm / M 9 7/8"x9 7/8"

29 mm

Fornito in fogli con rete davanti*
Supplied on sheets with net on good face*
Livrée en plaques avec trame sur belle face*
Geliefert mit Netz auf Vorderseite*

* Vedi dettagli a pagina: See details on page: Voir détails à la page: Siehe Details auf Seite: 238

LS Mix 820

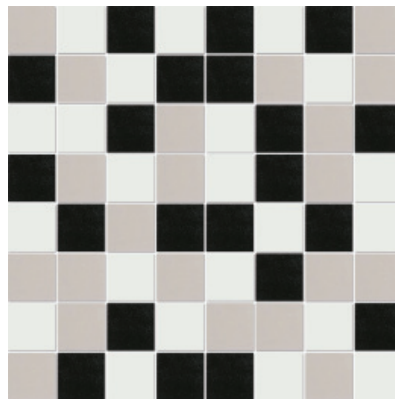

2700 820S

Satin



LS Mix 840

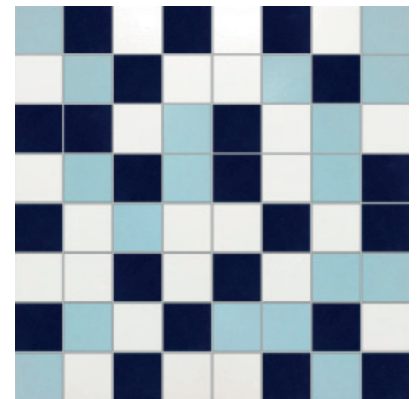

2700 840S

Satin



VANTAGGI ADVANTAGES AVANTAGES VORTEILE

Stesso spessore delle piastrelle Landscape
Same thickness of tiles of Series Landscape
Même épaisseur des carreaux Landscape
Gleiche Stärke der Platten der Serie Landscape

Stessi colori delle piastrelle Landscape
Same colours of tiles of Series Landscape
Mêmes couleurs des carreaux Landscape
Gleiche Farben der Platten der Serie Landscape

Modulare con i formati piscine
Modular with swimming pool sizes
Modulaire avec les formats piscines
Modulaer mit den Schwimmbadformaten



LS Uni Tundra

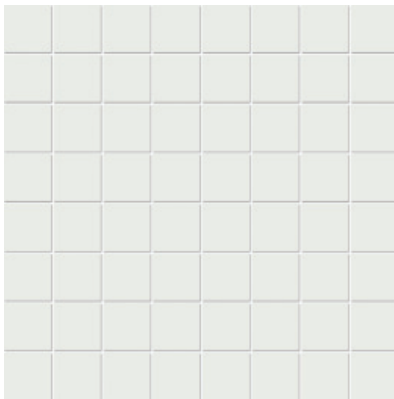

2700 100S

Satin



100 Tundra

2700 100G

Grip



100 Tundra



LS Uni Bay

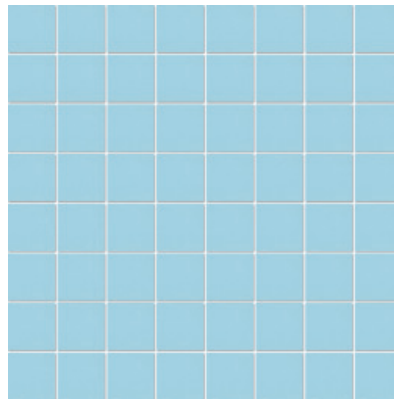

2700 200S

Satin



200 Bay

2700 200G

Grip



200 Bay

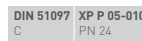

LS Uni Ocean

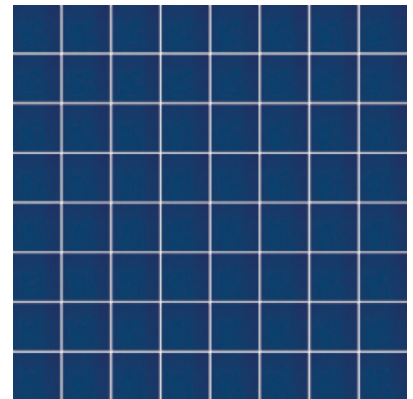

2700 202S

Satin



502 Ocean

2700 202G

Grip



502 Ocean



PEZZI SPECIALI FITTINGS PIECES SPECIALES FORMSTÜCKE

Bordo arrotondato Bord arrondi Bullnose Stehsocketel



2706 100S

LS-UNI B.C.

Tundra Satin



2706 100G

LS-UNI B.C.

Tundra Grip

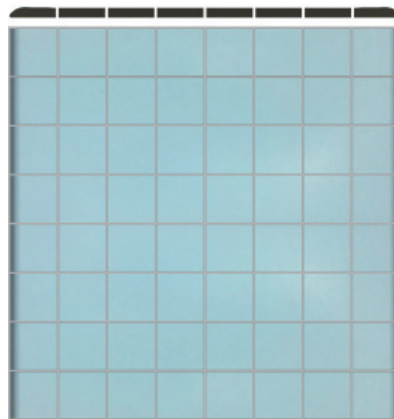

2706 200S

LS-UNI B.C.

Bay Satin



2706 200G

LS-UNI B.C.

Bay Grip

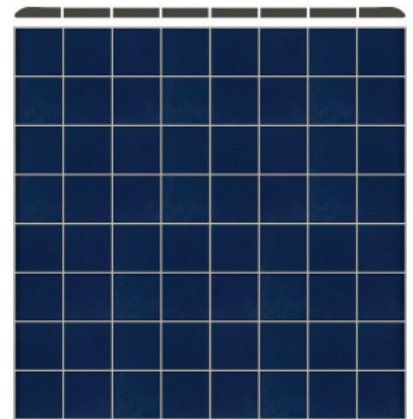
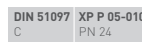

2706 202S

LS-UNI B.C.

Ocean Satin



2706 202G

LS-UNI B.C.

Ocean Grip

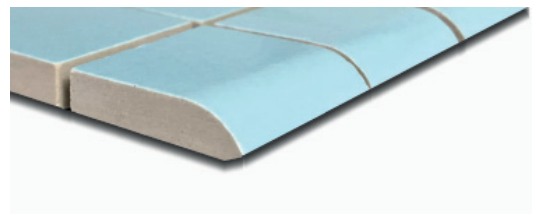
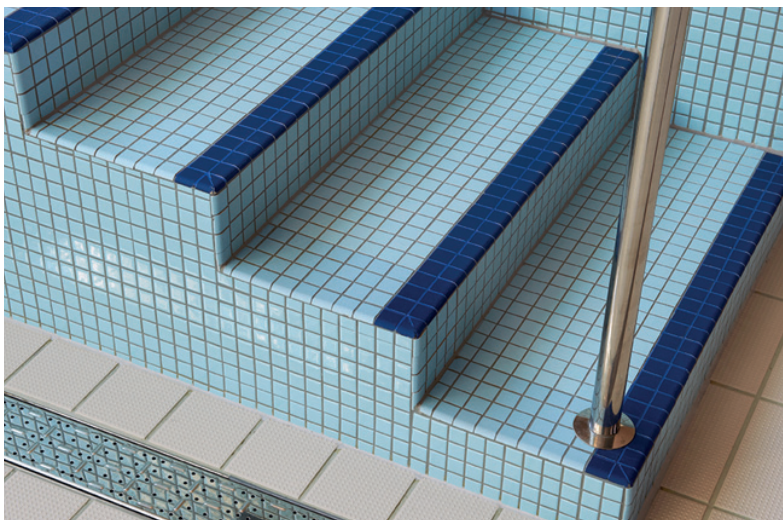

LANDSCAPE

DECOR MIX

8 mm

Sistema di decorazione basato sull' abbinamento di piastrelle di diverso formato e/o colore.

E' particolarmente indicato per la realizzazione di decorazioni di ampie dimensioni anche per i costi che restano relativamente contenuti.

Su richiesta è possibile sviluppare proposte personalizzate.

Decoration system organised on different colours and/or different size tiles.

Especially suitable for large-size decorations, also because it helps contain the price.

Custom application decorations are available on request.

Système de décoration fondé sur l'assortiment de carreaux de couleurs et/ou formats différents.

Spécialement indiqué pour la réalisation de grandes décorations, également en vertu de ses couts relativement réduits.

Décorations personnalisées sur demande.

Dieses Dekorationsssystem basiert auf der Kombination von Fliesen mit unterschiedlichen Formaten und/oder Farben.

Es eignet sich nicht zuletzt aufgrund der relativ geringen Kosten besonders gut für großflächige Dekorationen.

Auf Anfrage können individuelle Angebote erstellt werden.

Sole Azzurro

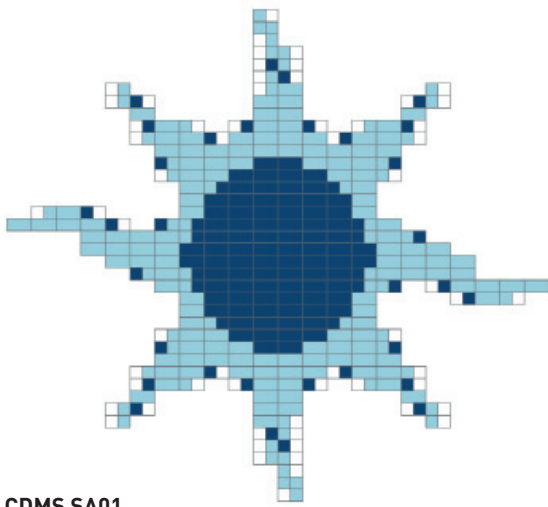

CDMS SA01

550x500 cm / 216¹³/₃₂" x 197"

Satin*



Delfino con Palla

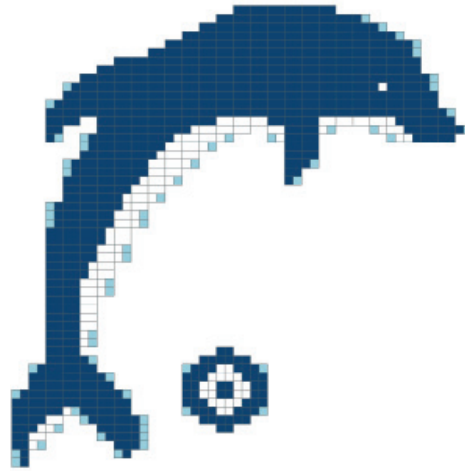

CDMS DP11

675x675 cm / 265³/₄" x 265³/₄"

Satin*



Balenottero grande

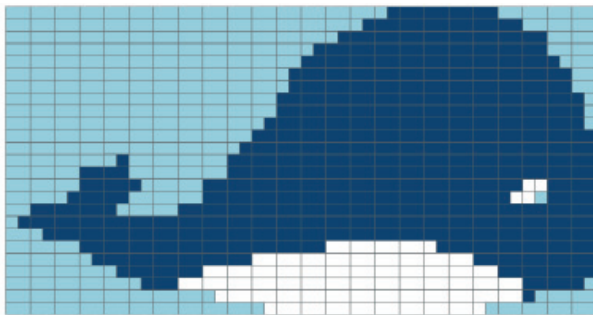

CDMS BLGR

600x312,5 cm / 236⁷/₃₂" x 123¹/₃₂"

Satin*

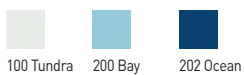

* A richiesta anche superficie Friction o Grip On request, also surface Friction or Grip Sur demande, surface Friction ou Grip Auf Anfrage, Oberfläche Friction oder Grip

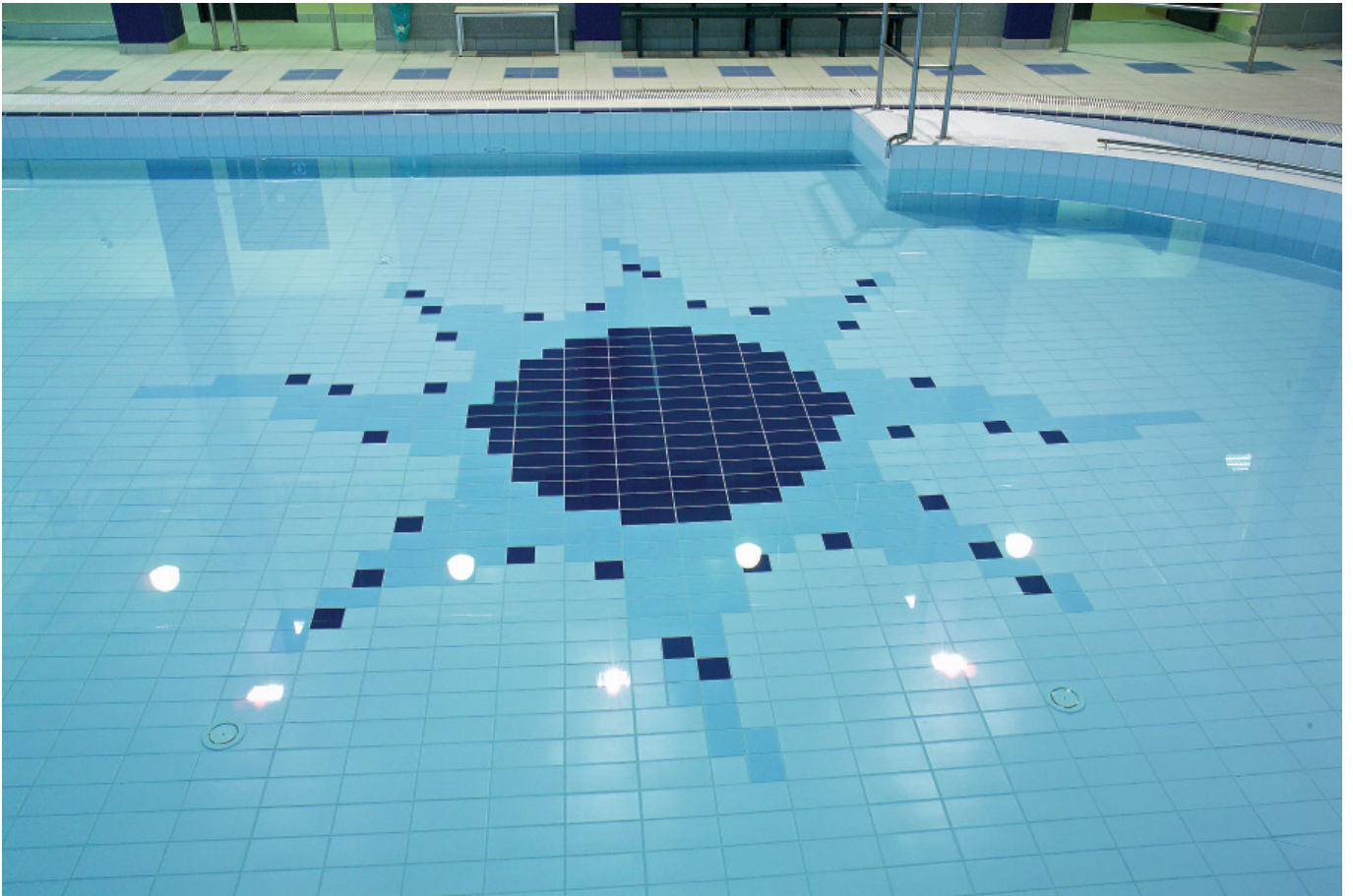

LANDSCAPE

DECOR JET

8 mm

Riproduzione di figure, loghi o marchi con tecnica del taglio a idrogetto.

Le piastrelle sono fornite tagliate e ri-assemblate su rete in nylon e numerate per facilitarne la posa.

Su richiesta è possibile sviluppare proposte personalizzate.

Water-jet cut figures, company logos or marks.

The tiles are supplied already cut and assembled on a nylon mesh and numbered for easier installation.

Custom solutions are available on request.

Reproduction de figures, symboles sociaux ou marques réalisés par découpage au jet d'eau.

Les carreaux sont livrés déjà coupés et collés sur trame en nylon et numérotés pour faciliter la pose.

Des solutions diverses sont possibles sur demande.

Hierbei handelt es sich um die Reproduktion von Figuren, Orten oder Marken mit der Wasserstrahlschnitttechnik.

Die Fliesen werden geschnitten und auf einem Nylonnetz wieder zusammengefügt geliefert. Sie sind zugunsten einer einfachen Verlegung nummeriert.

Auf Anfrage können individuelle Angebote erstellt werden.

Coppia Delfini

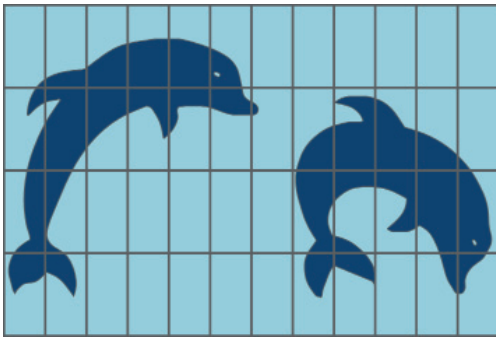

CDJS CD01

150x100 cm / 59^{1/16}" x 39^{3/8}"

Satin*

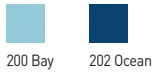

Polpo

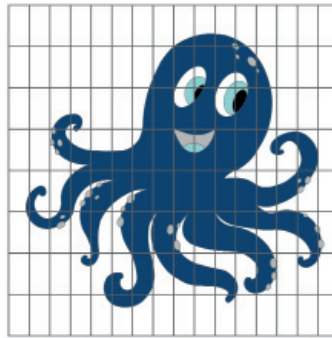

CDJS PLP1

200x200 cm / 78^{3/4}" x 78^{3/4}"

Satin*



Pesce palla

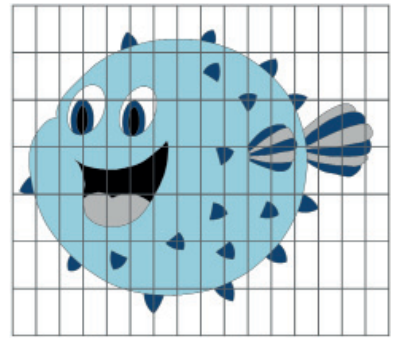

CDJS PSP1

220x175 cm / 78^{3/4}" x 68^{5/16}"

Satin*



Tartarughe

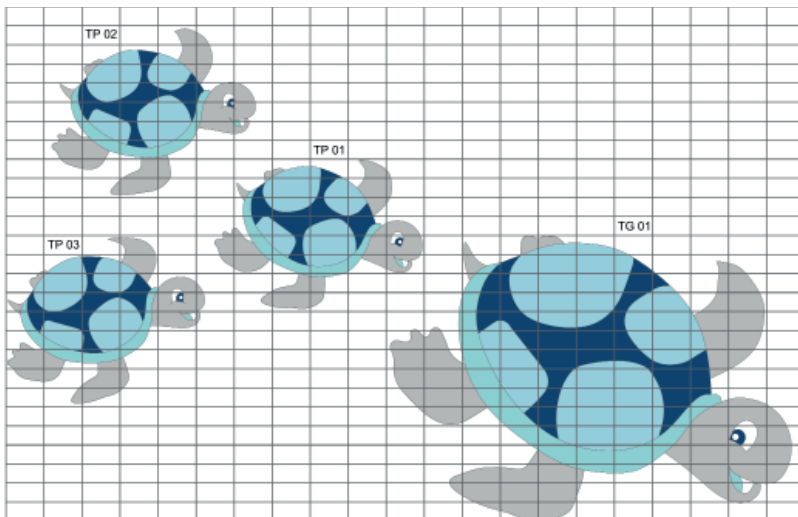

CDJS TP01 - CDJS TP02 - CDJS TP03

150x112,5 cm / 59^{1/16}" x 44^{9/32}"

CDJS TG01

275x187,5 cm / 108^{9/32}" x 73^{13/16}"

Satin*

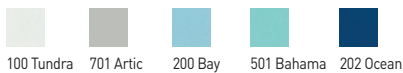

* A richiesta anche superficie Friction On request, also surface Friction Sur demande, surface Friction Auf Anfrage, Oberfläche Friction

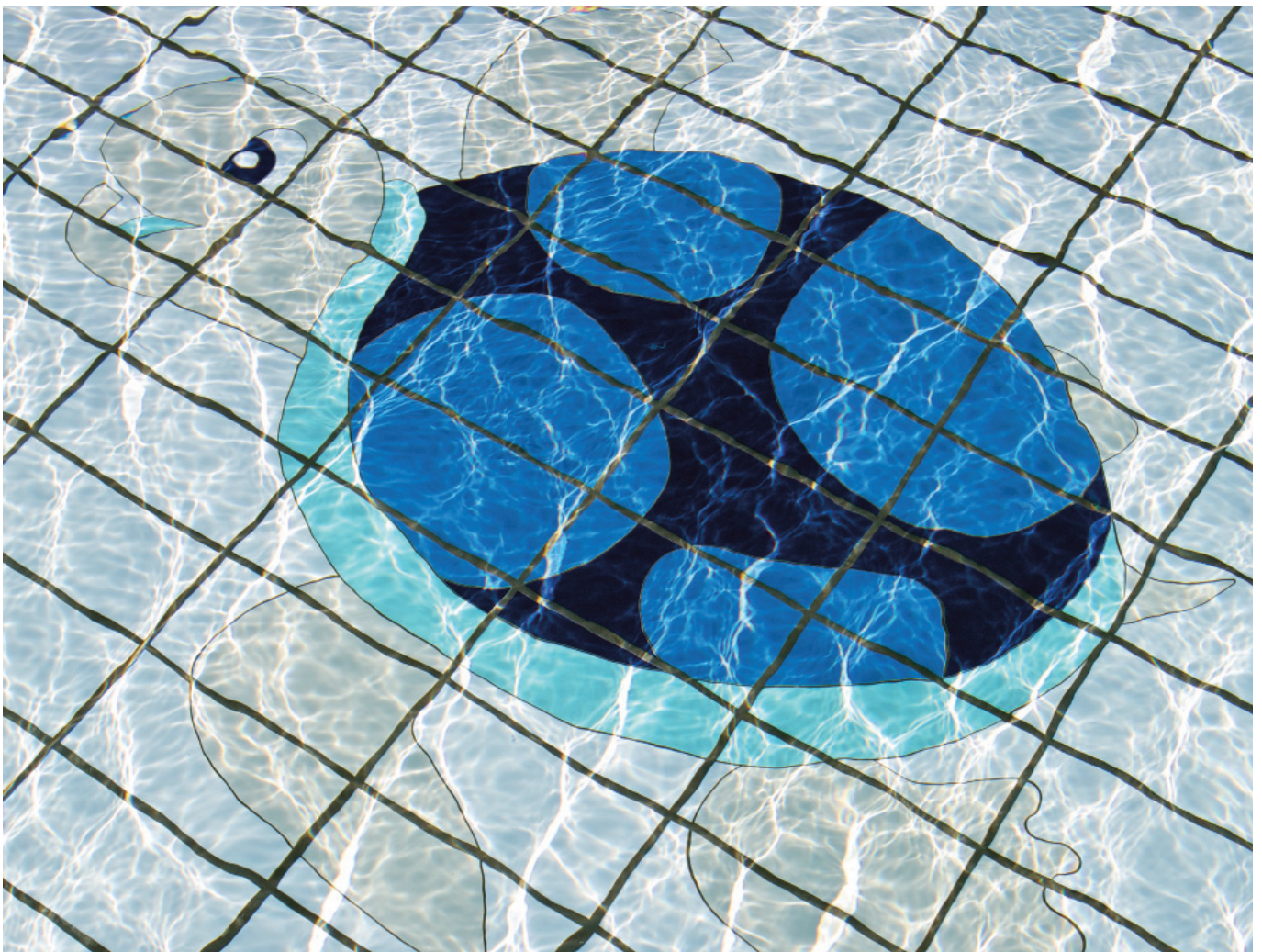
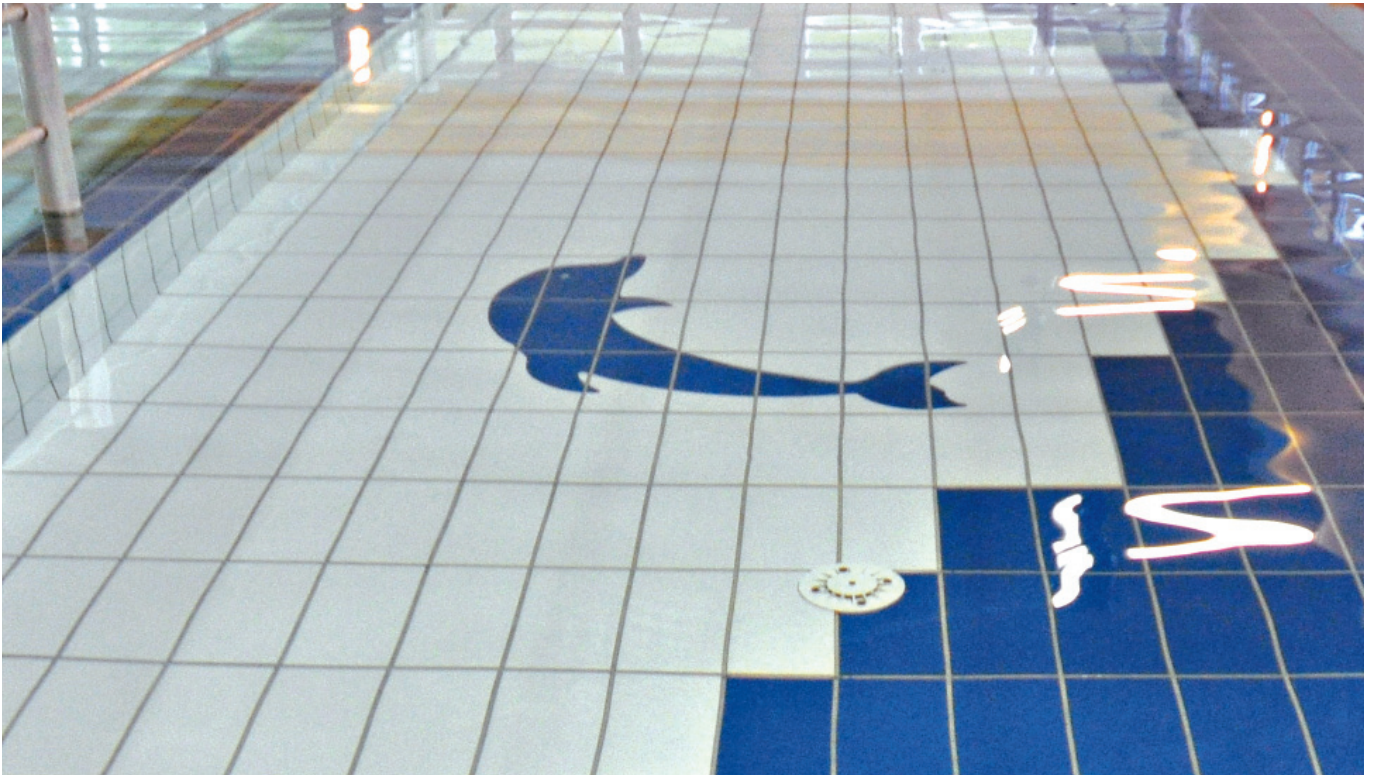

Elementi

GRANITOGRES

piastrelle in gres porcellanato non smaltato

UNGLAZED PORCELAIN TILES
 CARREAUX EN GRES CERAME NON EMAILLE
 UNGLASIERTE FEINSTEINZEUGFLIESEN

Gres porcellanato non smaltato colorato in massa e completamente vetrificato; Elementi è la serie di prodotti più resistente allo stress fisico, meccanico e chimico indicata quindi, con le idonee superfici, per tutti i tipi di pavimentazione, interne o esterne, degli ambienti piscina.

Le diverse superfici antiscivolo sono tutte realizzate profilando la materia stessa per garantire nel tempo la durata dei coefficienti antiscivolo originali.

Unglazed, mass-coloured and fully vitrified stoneware; Elementi is the most resistant product line to physical, mechanical and chemical stress. Therefore it is indicated, using the proper surface finish for all types of floors indoor and outdoor.

The different non-slip surfaces are formed by profiling the tile body directly, in order to secure durability of the original non-slip coefficients.

Grès cérame non émaillé, coloré et vitrifié pleine masse ; Elementi est la série aux propriétés de résistance mécanique et chimique plus performantes et elle donc indiquée, en utilisant la surface adéquate, pour tous les types de carrelages, à l'intérieur comme à l'extérieur.

Les différentes finitions antidérapantes sont réalisées moyennant la création de rugosités directement dans la matière, pour garantir la durée des coefficients antidérapants originaux.

In der Masse gefärbtes und vollkommen durchgesintertes unglasiertes Feinsteinzeug; Elementi ist eine gegenüber physischen, mechanischen und chemischen Belastungen widerstandsfähige Produktreihe mit den geeigneten Oberflächen für jegliche Fußböden im Innen- und Außenbereich.

Die verschiedenen rutschsicheren Oberflächen wurden mittels der Profilierung der Materie hergestellt, um auch langfristig den ursprünglichen Rutschfestigkeitskoeffizienten gewährleisten zu können.

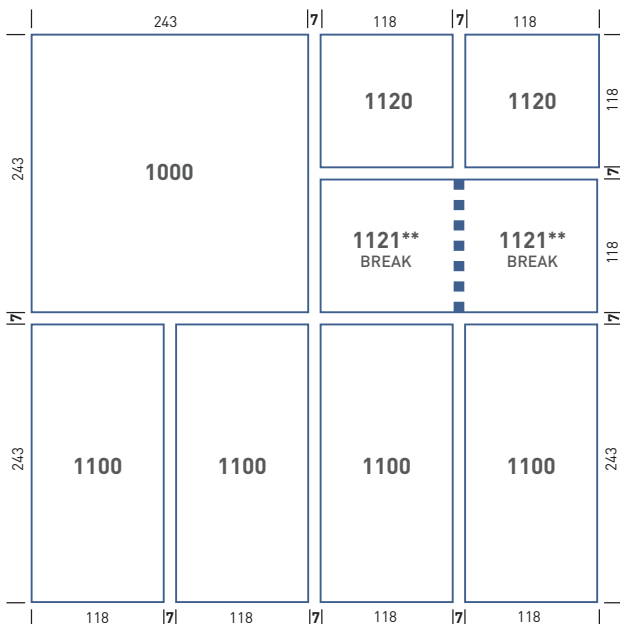

Codice formato Ref. format Format code Format Nr.	Misure di fabbricazione*** Cotes de fabrication Work sizes Herstellmasse	Misure nominali Cotes nominales Nominal sizes Nennmasse
1000	243x243 mm 9 ⁹ / ₁₆ " x 9 ⁹ / ₁₆ "	M*25x25 cm M*9 ⁷ / ₈ " x 9 ⁷ / ₈ "
1120	118x118 mm 4 ⁵ / ₈ " x 4 ⁴ / ₁₆ "	M*12,5x12,5 cm M*4 ⁷ / ₈ " x 4 ⁷ / ₈ "
1121** BREAK	118x118 mm x2 pc 4 ⁵ / ₈ " x 4 ⁵ / ₈ " x2pc	M*12,5x12,5 cm x 2 pc M*4 ⁷ / ₈ " x 4 ⁷ / ₈ " x 2 pc
1100	118x243 mm 4 ⁵ / ₈ " x 9 ⁹ / ₁₆ "	M*12,5x25 cm M*4 ⁷ / ₈ " x 9 ⁷ / ₈ "

* M = formato modulare modular size format modulaire modulformat

Importante: La modularità dei formati si ottiene con fuga di 7 mm

Important: Modularity of different sizes is based on 7 mm grouting joints.

Important: La modularité des formats est calculée avec un joint de 7 mm

Wichtig: Für Modulverlegung die empfohlene Fugenbreite ist 7 mm

** Da separare in cantiere To break on job site À séparer en chantier
 Spaltplatten auf Baustelle zubereiten

*** Calibro 0 Caliber 0 Pige 0 Kaliber 0

piastrelle in gres porcellanato non smaltato / unglazed porcelain tiles /
carreaux en grés cérame non émaillé / unglasierte Feinsteinzeugfliesen



Elementi - GRANITOGRES

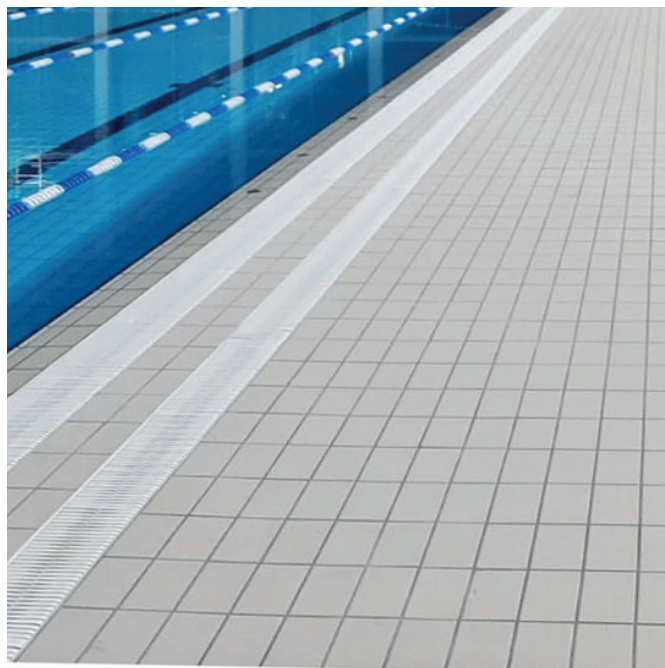

1121 - BREAK

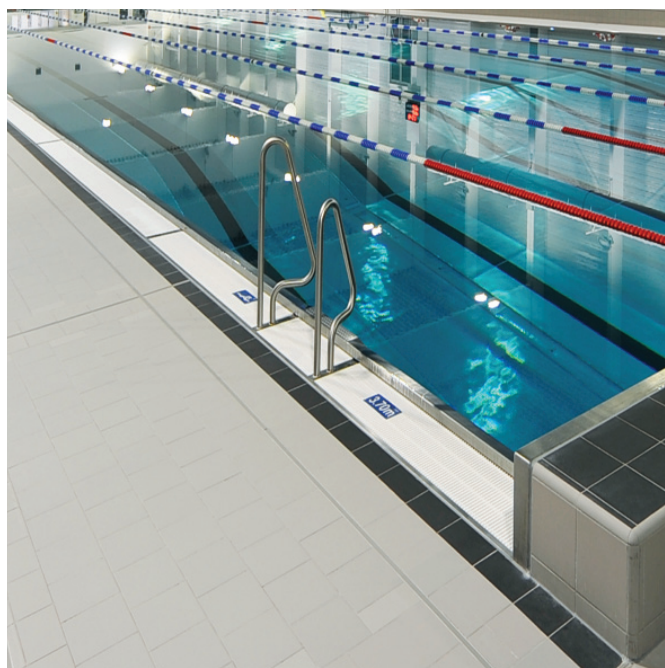

ESEMPIO CODIFICA PRODOTTI EXAMPLE PRODUCTS CODING EXAMPLE DE CODIFICATION DES PRODUITS BEISPIEL CODIERUNG DER PRODUKTE

Codice Code Code Kode	Codice formato o sagoma prodotto Code for size or shape of the product Code du format ou forme du produit Kode des Format oder Stückform des Artikels	Codice colore Colour code Code de la couleur Farbkode	Tipo di superficie Surface type Type de surface Oberflächenart
1100 010P	1100 = M12,5x25 cm / M4 ^{7/8} " x 9 ^{7/8} "	010 = Talco	P = Pinhead
1106 011M	1106 = Pezzo speciale / Fitting / Pièce spéciale / Formstück	011 = Avorio	M = Matt

Elementi

GRANITOGRES superfici

SURFACES
SURFACES
OBERFLÄCHEN

Matt = M

È caratterizzata da una leggera rugosità con un valore antiscivolo di gruppo B a piedi nudi ed il grado R10 a piedi calzati. È adatta per le aree intorno alle vasche, ma anche per spogliatoi e corridoi, generalmente umidi, sia all'interno che all'esterno.

Characterized by a slight rough surface finish with Group B barefoot non-slip and R10 shoed non-slip degree. Suitable for pool decks, but also locker rooms and corridors generally wet, both indoors and outdoors.

Caractérisée par une légère rugosité avec coefficient antidérapant pieds nus de groupe B et degré pieds chaussés R10. Indiquée pour les plages des piscines, les vestiaires, les couloirs et les zone mouillées, à l'intérieur comme à l'extérieur.

Ist durch eine leichte Oberflächenrauheit mit einem Rutschfestigkeitskoeffizienten der Gruppe B bei barfüßigem Betreten und der Gruppe R10 bei Betreten mit Schuhwerk gekennzeichnet. Eignet sich für die Beckenumgänge, aber auch für üblicherweise feuchte Umkleidekabinen und Flure, sowohl im Innen- als auch im Außenbereich.

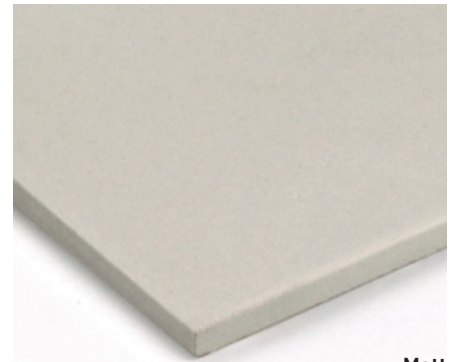

Matt

DIN 51097 B	XP P 05-010 PN 18	
DIN 51130 R 10 V	XP P 05-010 PC 10	

Pinhead = P

Evidenzia profili semi-sferici a rilievo che garantiscono un valore antiscivolo di gruppo C a piedi nudi e il grado R11 a piedi calzati. La regolare disposizione dei rilievi, oltre a facilitare la pulizia, permette un deflusso dei liquidi di classe V6 (Norma DIN 51130) riducendo ristagni di acqua evitando fenomeni di aquaplaning. Realizzata anche su alcuni pezzi speciali per bordo vasca, è sicuramente il tipo di superficie più indicato per le aree adiacenti alle vasche e altre zone generalmente bagnate o immerse in acqua.

Features semi-spherical relief profiles that guarantee Group C barefoot non-slip coefficient and R11 shoed non-slip degree. The regular arrangement of the profiles allows for easy cleaning and V6-class fluid flow (according to DIN 51130), which prevents water accumulation and aquaplaning. Also available on some fittings for pool borders, this is undoubtedly the most suitable surface for pools decks and other wet and/or submerged areas.

Caractérisée par des picots semi-sphériques en relief qui garantissent un coefficient antidérapant pieds nus de groupe C et le degré pieds chaussés R11. La disposition régulière des reliefs permet un nettoyage facile et l'écoulement des fluides de classe V6 (conformément à la norme DIN 51130), ce qui permet d'éviter des accumulations d'eau et de prévenir les phénomènes d'aquaplaning. Réalisée également sur certaines pièces spéciales pour les têtes des bassins, cette surface est sans aucun doute la plus indiquée pour les plages des piscines et toute autre zone généralement mouillée ou plongée dans l'eau.

Weist halbrunde erhöhte Profile auf, die einen Rutschfestigkeitskoeffizienten der Gruppe C bei barfüßigem Betreten und der Gruppe R11 bei Betreten mit Schuhwerk gewährleisten. Die regelmäßige Anordnung der Profile vereinfacht nicht nur die Reinigung, sondern schafft auch einen Verdrängungsraum, der der Klasse V6 (Norm DIN 51130) entspricht, wodurch Wasseranstauungen reduziert und Aquaplaning-Phänomene vermieden werden können. Diese Oberfläche, mit der auch einige Formteile für Schwimmbeckenränder hergestellt werden, eignet sich mit Gewissheit für die Beckenumgänge und für andere Zonen, die üblicherweise feucht oder unter Wasser sind.

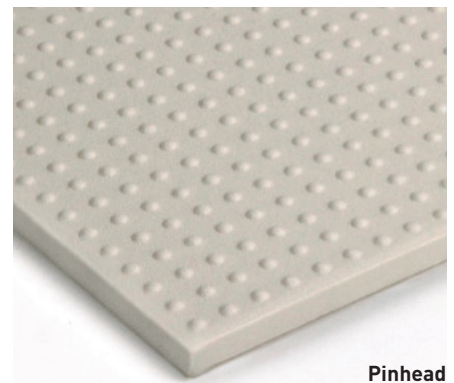

Pinhead

DIN 51097 C	XP P 05-010 PN 24	
DIN 51130 R 11 V 6	XP P 05-010 PC 20	

Roccia = R

La superficie ha una struttura irregolare con un grado di antiscivolosità di gruppo C a piedi nudi ed il valore di R12 a piedi calzati. L'aspetto tipo "spaccato di pietra" rende preferibile questo tipo di superficie per pavimentazioni in esterno.

Irregular surface structure with Group C barefoot non-slip coefficient and R12 shoed non-slip coefficient. This "stone look" effect makes this surface finish an ideal solution for outdoor applications.

Surface à structure irrégulière avec coefficient antidérapant pieds nus de groupe C et degré pieds chaussés R12. Son « effet pierre » fait de cette surface le revêtement idéal pour toutes les applications extérieures.

Die Oberfläche hat eine unregelmäßige Struktur mit einem Rutschfestigkeitskoeffizienten der Gruppe C bei barfüßigem Betreten und der Gruppe R12 bei Betreten mit Schuhwerk. Das typische "Spaltstein"-Aussehen macht diese Oberflächenart besonders für Fußböden im Außenbereich geeignet.

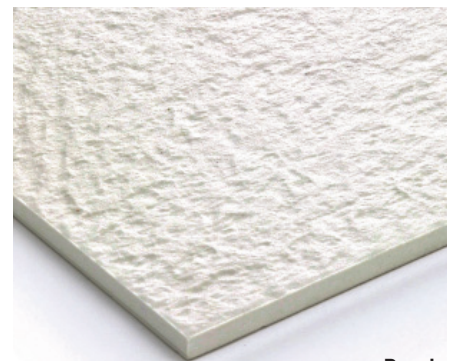

Roccia

DIN 51097 C	XP P 05-010 PN 24	
DIN 51130 R 12 V	XP P 05-010 PC 27	

Rigata-Cannelé = C

Dedicata ai pezzi speciali 3200 e 3220 (vedi pag. 49), è una superficie con righe in rilievo da posare trasversalmente al senso di marcia per poter beneficiare di un grado di antiscivolosità di gruppo C a piedi nudi.

This surface is focused on the special fittings 3200 and 3220 (see page 49) and it is characterized by relief grooves to be arranged crosswise to traffic direction in order to ensure a Group C barefoot anti-slip degree.

Cette surface est destinée aux pièces spéciales 3200 et 3220 (voir pag. 49), étant caractérisée par des cannelures en relief à poser transversalement au sens de marche pour bénéficier d'un degré anti-glissement pieds nus de groupe C.

Diese Oberfläche ist für die Formstücke 3200 und 3220 (siehe Seite 49) bestimmt und hat Reliefstreifen, die quer zur Laufrichtung verlegt werden müssen, um die Rutschfestigkeitsklasse C bei barfusigem Betreten zu gewährleisten.



Rigata - Cannelé

DIN 51097 C	XP P 05-010 PN 24	
DIN 51130 R 12 V 8	XP P 05-010 PC 27	

ELEMENTI

Gruppo B1a UGL

8 mm

Talco 010

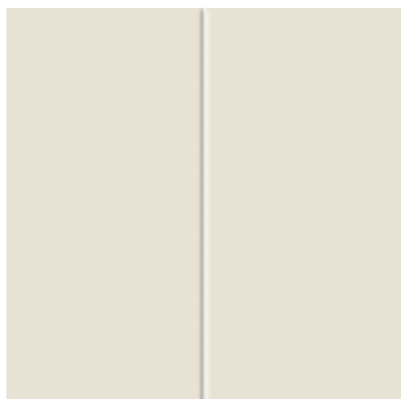

Matt

1100 010M	M12,5x25 cm / M4 ^{7/8} "x9 ^{7/8} "
1000 010M	M25x25 cm / M9 ^{7/8} "x9 ^{7/8} "
1120 010M	M12,5x12,5 cm / M4 ^{7/8} "x4 ^{7/8} "
1121 010M	M12,5x12,5 cm x2 pc / M4 ^{7/8} "x4 ^{7/8} " x2 pc

Pinhead

1100 010P	M12,5x25 cm / M4 ^{7/8} "x9 ^{7/8} "
1000 010P	M25x25 cm / M9 ^{7/8} "x9 ^{7/8} "
1120 010P	M12,5x12,5 cm / M4 ^{7/8} "x4 ^{7/8} "

Roccia

1000 010R	M25x25 cm / M9 ^{7/8} "x9 ^{7/8} "
-----------	--

Cemento 060



Matt

1100 060M	M12,5x25 cm / M4 ^{7/8} "x9 ^{7/8} "
1000 060M	M25x25 cm / M9 ^{7/8} "x9 ^{7/8} "

Pinhead

1100 060P	M12,5x25 cm / M4 ^{7/8} "x9 ^{7/8} "
1000 060P	M25x25 cm / M9 ^{7/8} "x9 ^{7/8} "

Roccia

1000 060R	M25x25 cm / M9 ^{7/8} "x9 ^{7/8} "
-----------	--

Basalto 061

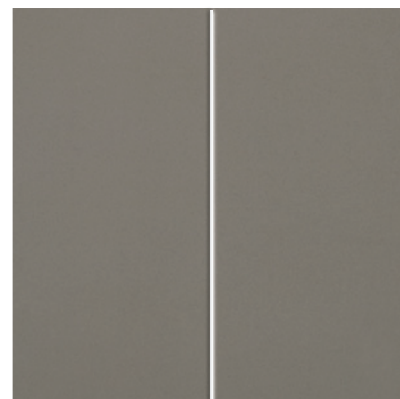

Matt

1100 061M	M12,5x25 cm / M4 ^{7/8} "x9 ^{7/8} "
1000 061M	M25x25 cm / M9 ^{7/8} "x9 ^{7/8} "

Pinhead

1100 061P	M12,5x25 cm / M4 ^{7/8} "x9 ^{7/8} "
1000 061P	M25x25 cm / M9 ^{7/8} "x9 ^{7/8} "

Avorio 011

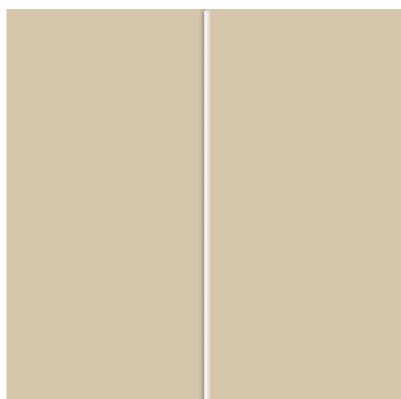

Matt

1100 011M	M12,5x25 cm / M4 ^{7/8} "x9 ^{7/8} "
1000 011M	M25x25 cm / M9 ^{7/8} "x9 ^{7/8} "
1120 011M	M12,5x12,5 cm / M4 ^{7/8} "x4 ^{7/8} "
1121 011M	M12,5x12,5 cm x2 pc / M4 ^{7/8} "x4 ^{7/8} " x2 pc

Pinhead

1100 011P	M12,5x25 cm / M4 ^{7/8} "x9 ^{7/8} "
1000 011P	M25x25 cm / M9 ^{7/8} "x9 ^{7/8} "
1120 011P	M12,5x12,5 cm / M4 ^{7/8} "x4 ^{7/8} "

Ebano 070

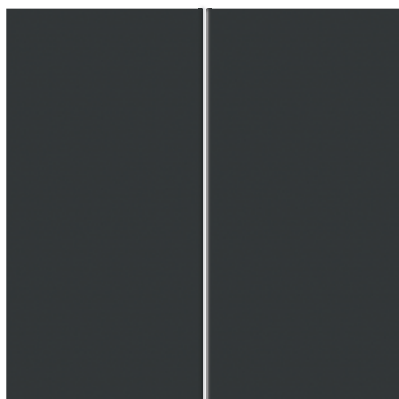

Matt

1100 070M	M12,5x25 cm / M4 ^{7/8} "x9 ^{7/8} "
1000 070M	M25x25 cm / M9 ^{7/8} "x9 ^{7/8} "

Pinhead

1100 070P	M12,5x25 cm / M4 ^{7/8} "x9 ^{7/8} "
1000 070P	M25x25 cm / M9 ^{7/8} "x9 ^{7/8} "

Mare 021

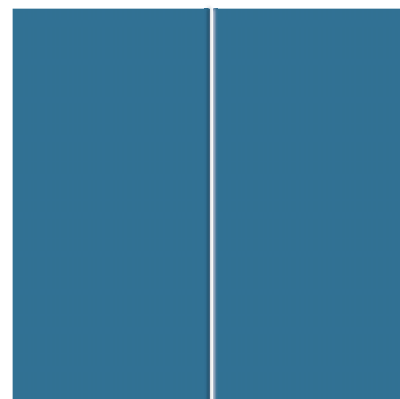





Matt

1100 021M	M12,5x25 cm / M4 ^{7/8} "x9 ^{7/8} "
1000 021M	M25x25 cm / M9 ^{7/8} "x9 ^{7/8} "
1120 021M	M12,5x12,5 cm / M4 ^{7/8} "x4 ^{7/8} "

Pinhead



1100 021P	M12,5x25 cm / M4 ^{7/8} "x9 ^{7/8} "
1000 021P	M25x25 cm / M9 ^{7/8} "x9 ^{7/8} "
1120 021P	M12,5x12,5 cm / M4 ^{7/8} "x4 ^{7/8} "



	 1120	 1121 break**	 1100	 1000
Formati Sizes Formats Formate	cm M* 12,5x12,5 4 ⁷ / ₈ " x 4 ⁷ / ₈ "	cm M* 12,5x12,5 2 pc 4 ⁷ / ₈ " x 4 ⁷ / ₈ "	cm M* 12,5x25 4 ⁷ / ₈ " x 9 ⁷ / ₈ "	cm M* 25x25 9 ⁷ / ₈ " x 9 ⁷ / ₈ "
Talco 010	● ●	●	● ●	● ● ●
Cemento 060			● ●	● ● ●
Basalto 061			● ●	● ●
Avorio 011	● ●	●	● ●	● ●
Ebano 070			● ●	● ●
Mare 021	● ●		● ●	● ●
	mm 8	mm 8	mm 8	mm 8



● Matt

● Pinhead

● Roccia

DIN 51097 B	XP P 05-010 PN 18	
DIN 51130 R 10 V	XP P 05-010 PC 10	

DIN 51097 C	XP P 05-010 PN 24	
DIN 51130 R 11 V 6	XP P 05-010 PC 20	







DIN 51097 C	XP P 05-010 PN 24	
DIN 51130 R 12 V	XP P 05-010 PC 27	

* M = formato modulare modular size format modulaire modulformat

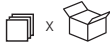
** Da separare in cantiere To break on job site À séparer en chantier Spaltplatten auf Baustelle zubereiten

Caratteristiche tecniche a pagina: Technical features on page: Caractéristiques techniques à la page: Technische Eigenschaften auf Seite: 232

PESI, MISURE E CONTENUTO DEI COLLI WEIGHT, SIZE AND CONTENTS OF THE PACKING
POIDS, DIMENSIONS, CONTENU DES COLIS VERPACKUNGSGRÖSSEN/GEWICHTE

								
1120 M12,5x12,5	Matt	64	64	1,00	72	72,00	17	1224
	Pinhead	60		0,938		67,46		1146
1121 M12,5x25 x2 pc	Matt	32 x2	64	1,00	78	78,00	17	1326
1100 M12,5x25	Matt	32	32	1,00	78	78,00	17	1326
	Pinhead	30		0,938		73,12		1243
1000 M25x25	Matt	16	16	1,00	78	78,00	17	1326
	Pinhead	15		0,938		73,12		1243
	Roccia	16		1,00		78,00		1326

Padana Trim

pezzi speciali e sistema Trim-Box

TRADITIONAL FITTINGS AND TRIM-BOX SYSTEM
PIECES SPECIALES ET SYSTEME TRIM-BOX
TRADITIONELLE FORMSTÜCKE UND DAS SYSTEM TRIM-BOX

La realizzazione di piscine ed impianti sportivi richiede l'impiego di un gran numero di pezzi speciali in ceramica che consentano il rivestimento di sagome particolari e di adattarsi alle forme degli elementi costruttivi ed architettonici.

Accanto alla produzione di pezzi speciali tradizionali la divisione Swimming Pool di Casalgrande Padana ha creato l'esclusivo sistema Trim Box, un insieme di pezzi speciali di nuova concezione che, oltre a garantire un elevato livello estetico e qualitativo, facilita e velocizza le operazioni di messa in opera.

L'utilizzo del sistema Trim Box offre diversi vantaggi:

- I pezzi speciali dedicati alla realizzazione di bordi vasca di tipo finlandese hanno lo stesso spessore e non è perciò necessario creare sagome particolari nel cemento armato.
- Ogni pezzo dispone anche del relativo mezzo-pezzo per facilitare la realizzazione di bordi vasca con parti curve.
- Ogni elemento è disponibile nella duplice versione con e senza tallone in ceramica per il supporto della griglia.

Swimming pools and sports facilities involve the use of a large number of fittings to clad specific profiles and shapes of architectural elements.

In addition to the production of traditional fittings, Casalgrande Padana's Swimming Pool Division designed the exclusive Trim-Box system, a collection of new-concept fittings that also improve the aesthetics while facilitating and simplifying installation.

The Trim-Box system offers a number of advantages:

- All fittings dedicated for Finnish pool borders have same thickness and therefore do not require the concrete to come in special shapes.
- Each reference is available in the half-size in order to facilitate the lay-out of curved pool borders.
- All elements are available with and without ceramic support for the grid.

La construction de piscines et d'installations sportives exige le recours à plusieurs pièces céramiques spéciales pour le revêtement de certains profils et leur adaptation aux formes des éléments architecturaux.

En plus de la production de pièces spéciales traditionnelles, la division Swimming Pool de Casalgrande Padana a conçu le système exclusif Trim Box, un ensemble de pièces spéciales avant-gardistes qui tout en améliorant le niveau esthétique de l'ouvrage facilite et simplifie le travail de pose.

Le système Trim Box offre plusieurs avantages :

- Les pièces dédiées à la réalisation des têtes des bassins finlandais ont la même épaisseur et n'exigent donc aucun façonnage dans le béton.
- Pour chaque référence est disponible la version en demi-pièce pour faciliter la réalisation des têtes de bassin arrondies.
- Toutes les références sont disponibles dans la version sans ou avec talon céramique pour le support de la grille.

Die Konstruktion von Schwimmbädern und Wassersportanlagen macht die Verwendung einer großen Anzahl von Keramikformstücken erforderlich, die die Verkleidung von außergewöhnlichen Profilen sowie die Anpassung an die Bauteile und an die architektonischen Elemente ermöglichen.

Nebst der Herstellung von traditionellen Formstücken hat die Abteilung Swimming Pool von Casalgrande Padana auch das exklusive System Trim Box entwickelt. Hierbei handelt es sich um ein Sortiment neu konzipierter Formteile, die nicht nur eine hochwertige Ästhetik und Spitzenqualität gewährleisten, sondern auch die Verlegungsarbeiten erleichtern und beschleunigen.

Die Verwendung des Systems Trim Box bietet verschiedene Vorteile:

- Die für die Konstruktion der finnischen Rinnen bestimmten Formteile haben dieselbe Stärke, und die Kreation besonderer Profile im Stahlbeton ist daher nicht erforderlich.
- Zur Vereinfachung der Verlegung von Beckenrändern mit Kurvenabschnitten ist für alle Formteile auch das halbierte Formteil verfügbar.
- Ein jedes Teil ist in doppelter Ausführung mit und ohne Keramiksockel für die Rostauflage erhältlich.

Pezzi tradizionali
 Traditional fittings
 Pièces traditionnelles
 Traditionelle Formstücke

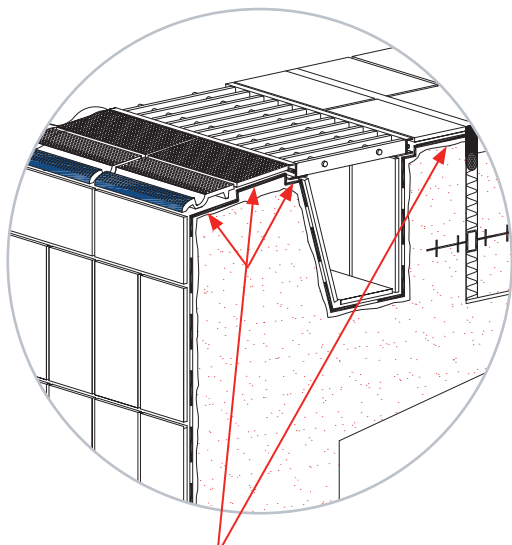

sagoma supporto irregolare
 irregular shape of concrete
 forme du beton irreguliere
 unregelmässige stahlbeton

Sistema Trim-Box
 Trim-Box system
 Système Trim-Box
 System Trim-Box

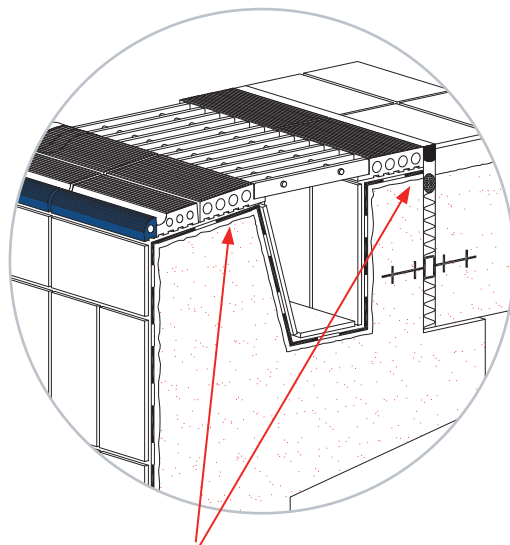

sagoma supporto lineare
 linear shape of concrete
 forme du beton lineaire
 regelmässige stahlbeton

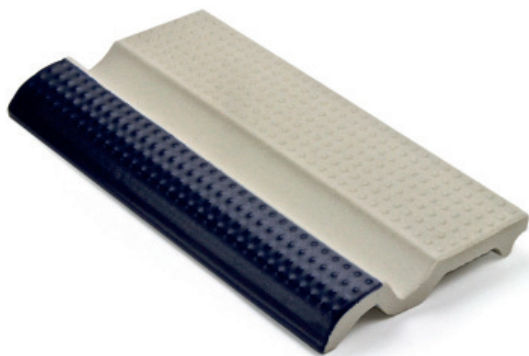

art. 7300

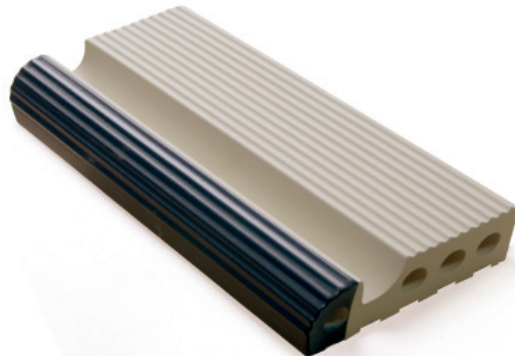

art. 7500

Polyfill

sistema brevettato di tamponamento dei pezzi Trim-Box

PATENTED PLUGGING SYSTEM FOR TRIM-BOX FITTINGS
SYSTEME BREVETE DE REMPLISSAGE DES PIECES TRIM-BOX
PATENTIERTES SYSTEM ZUM AUSFÜLLEN DER FORMTEILE TRIM BOX

Per migliorare l'ancoraggio del materiale utilizzato per le fughe e per contenere il peso dei pezzi, i pezzi speciali del sistema Trim Box sono stati progettati con uno o più fori passanti.

Qualora i pezzi Trim-Box siano da posare in esterno o in presenza di gelo e/o di forti sbalzi termici è sempre necessario prevedere l'impiego dei profili Polyfill.

Oltre a prevenire i possibili danni da gelo, i profili Polyfill consentono inoltre di ridurre lo spreco di materiale fugante che altrimenti andrebbe a perdersi dentro i fori.

In order to improve adherence of grouting materials and reduce their weight, Trim Box fittings have been designed with one or more through holes.

For installation outdoors or in freezing and/or high thermal shock environments, it is always required to use Polyfill profiles.

Besides preventing possible frost-related damages, Polyfill profiles prevents the waste of grout, which would be otherwise lost in the through-holes.

Pour améliorer l'ancrage du produit utilisé pour les joints et réduire le poids, certaines pièces spéciales du système Trim Box ont été créées avec un ou plusieurs trous de passage.

Pour la pose à l'extérieur ou en cas de gel et/ou de chocs thermiques élevés, il faut toujours employer les profils Polyfill.

En outre, les profils Polyfill permettent de réduire le gaspillage des produits de jointoiment, qui seraient destinés, dans le cas contraire, à disparaître dans les trous.



Für einen verbesserten Halt des für die Fugen verwendeten Materials und zugunsten einer Gewichtsreduzierung der Teile wurden die Formteile des Systems Trim Box mit einer oder mit mehreren Durchgangsbohrungen entworfen.

Werden die Trim-Box-Teile im Außenbereich oder in Bereichen mit Frostgefahr und/oder starken Temperaturschwankungen verlegt, müssen stets die Polyfill-Profile verwendet werden.

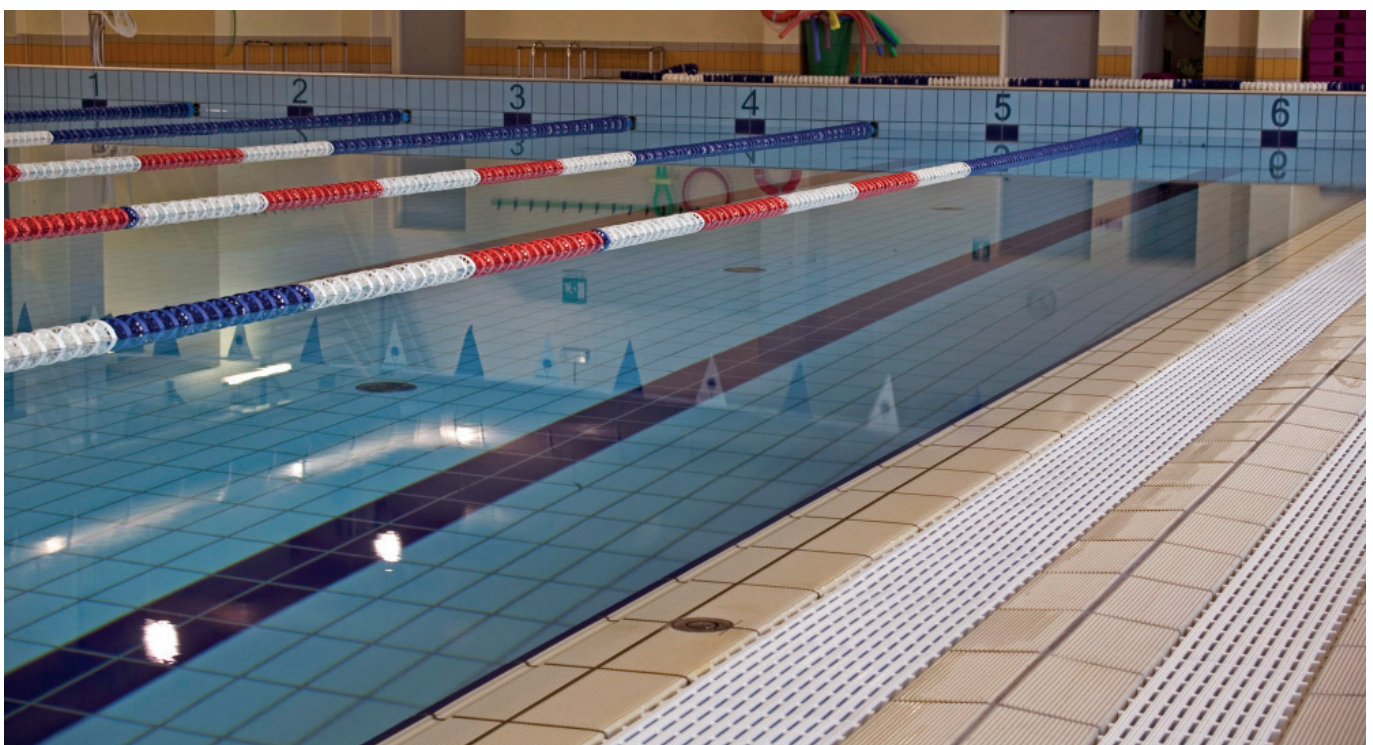
Die Polyfill-Profile beugen nicht nur etwaigen Forstschäden vor, sondern ermöglichen des Weiteren auch eine Reduzierung der Verschwendung des Fugenmaterials, das sich ansonsten in den Löchern ausbreiten würde.

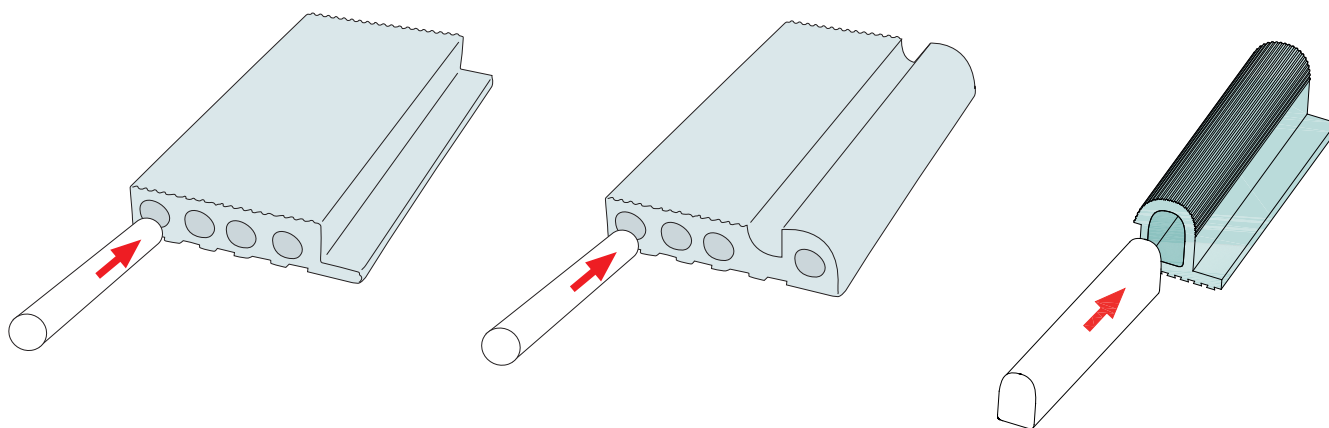

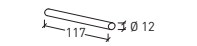
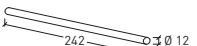
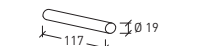
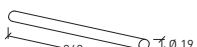

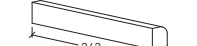
	Codice Code Code Kode	Descrizione Description Description Beschreibung	Dimensioni Sizes Dimensions Format	Per articoli For items Pour articles Für artiklen	
	P213-0242	Polyfill cilindro Polyfill cylinder Polyfill cylindre Polyfill Zylinder	9x242 mm	7700 (4 pcs)	
	P107-0117		12x117 mm	7520 (4 pcs) - 7820 (4 pcs)	
	P106-0242		12x242 mm	7500 (4 pcs) - 7800 (4 pcs) - 7700 (4 pcs)	
	P103-0117		19x117 mm	8120 (4 pcs) - 8620 (4 pcs) - 8820 (4 pcs) 9042 (4 pcs) - 9542 (4 pcs)	
	P102-0242		19x242 mm	8100 (4 pcs) - 8600 (4 pcs) - 8800 (4 pcs) 9046 (4 pcs) - 9546 (4 pcs)	
	P105-0117		Polyfill profilo Polyfill profil Polyfill profile Polyfill Profil	117 mm	6020 (1 pcs) - 6520 (1 pcs)
	P104-0242			242 mm	6050 (1 pcs) - 6550 (1 pcs)

SUPPORTO GRIGLIA GRID SUPPORT CORNIERE SUPPORT DE GRILLE ROSTAUFLAGEWINKEL

Vedi pagina: See page: Voir page: Siehe Seite: 65

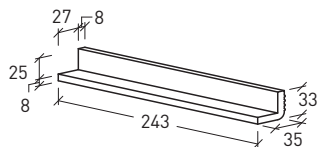

0500

Padana-Grid 36 pc/box 0,25 kg/pc 4 pc/ml

LANDSCAPE - Satin



100 Tundra

BATTISCOPA BULLNOSE BORD ARRONDI STEHSCOCKEL

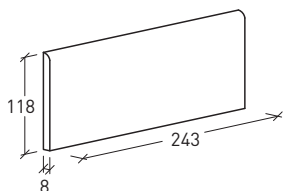

1106

32 pc/box 0,50 kg/pc 4 pc/ml (Grip)
26 pc/box 0,50 kg/pc 4 pc/ml (Matt)

LANDSCAPE - Satin



100 Tundra



200 Bay



202 Ocean

ELEMENTI - Matt



010 Talco



011 Avorio



021 Mare



060 Cemento



061 Basalto



070 Ebano

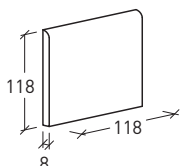

1126

64 pc/box 0,25 kg/pc 8 pc/ml

LANDSCAPE - Satin



100 Tundra



200 Bay



202 Ocean

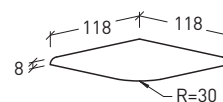

1109

10 pc/box 0,25 kg/pc

LANDSCAPE - Satin



100 Tundra



200 Bay



202 Ocean

ELEMENTI - Matt



010 Talco



011 Avorio



021 Mare



060 Cemento



061 Basalto



070 Ebano

ANTISCIVOLO CON BORDO ARROTONDATO NON SLIP WITH ROUNDED EDGE ANTIDERAPANT AVEC BORD ARRONDI NON-SLIP MIT GERUNDETE KANTE

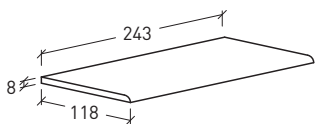

1106

32 pc/box 0,50 kg/pc 4 pc/ml (Satin)
26 pc/box 0,50 kg/pc 4 pc/ml (Matt)

LANDSCAPE - Grip



100 Tundra



200 Bay



202 Ocean



700 Lava

ELEMENTI - Matt



010 Talco



011 Avorio



021 Mare



060 Cemento



061 Basalto



070 Ebano

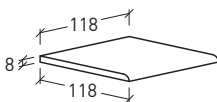

1126

64 pc/box 0,25 kg/pc 8 pc/ml

LANDSCAPE - Grip



100 Tundra



200 Bay



202 Ocean

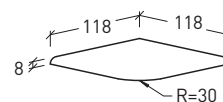

1109

10 pc/box 0,25 kg/pc

LANDSCAPE - Grip



100 Tundra



200 Bay



202 Ocean



700 Lava

ELEMENTI - Matt



010 Talco



011 Avorio



021 Mare



060 Cemento



061 Basalto



070 Ebano

PINHEAD CON BORDO ARROTONDATO PINHEAD WITH ROUNDED EDGE PINHEAD AVEC BORD ARRONDI PINHEAD MIT GERUNDETE KANTE

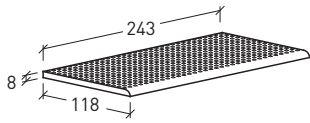
**1106**

26 pc/box 0,50 kg/pc 4 pc/ml

ELEMENTI - Pinhead

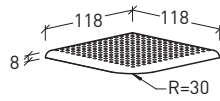
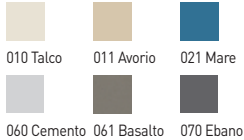
**1109**

10 pc/box 0,25 kg/pc

ELEMENTI - Pinhead

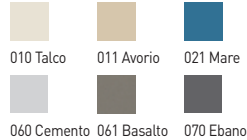

PIASTRELLA RIGATA RIBBED TILE CARREAU STRIE RILLENPLATTE

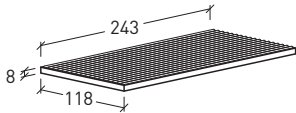
**3200**

28 pc/box 0,50 kg/pc 4 pc/ml

LANDSCAPE - Rigata

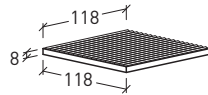

ELEMENTI - Rigata

**3220**

10 pc/box 0,25 kg/pc 8 pc/ml

LANDSCAPE - Rigata



ELEMENTI - Rigata

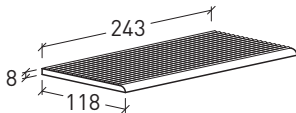

RIGATA CON BORDO ARROTONDATO RIBBED TILE WITH ROUNDED EDGE CARREAU STRIE AVEC BORD ARRONDI RILLENPLATTE MIT GERUNDETE KANTE

**3206**

28 pc/box 0,50 kg/pc 4 pc/ml

LANDSCAPE - Rigata

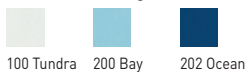

ELEMENTI - Rigata

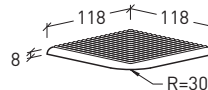
**3209**

10 pc/box 0,25kg/pc

LANDSCAPE - Rigata

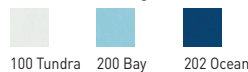

ELEMENTI - Rigata



RIGATA CON BORDO ARROTONDATO E MARCATURA DI SICUREZZA RIBBED TILE WITH ROUNDED EDGE AND SECURITY MARKING
 CARREAU STRIE AVEC BORD ARRONDI ET MARQUAGE DE SECURITE RILLENPLATTE MIT GERUNDETE KANTE UND SICHERHEITSMARKIERUNG

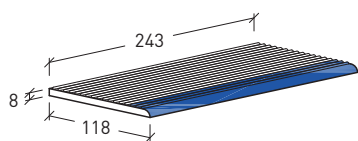

3346 Banda Blu

26 pc/box 0,50 kg/pc 4 pc/ml

LANDSCAPE - Rigata



100 Tundra 200 Bay

ELEMENTI - Rigata



010 Talco

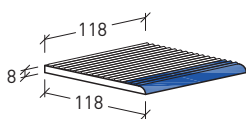

3342 Banda Blu

52 pc/box 0,25 kg/pc 8 pc/ml

LANDSCAPE - Rigata



100 Tundra

ELEMENTI - Rigata



010 Talco

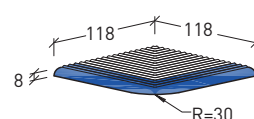

3349 Banda Blu

10 pc/box 0,25kg/pc

LANDSCAPE - Rigata



100 Tundra

ELEMENTI - Rigata



010 Talco

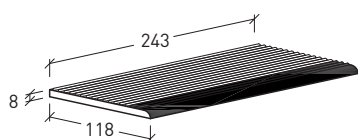

3346 Banda Nera

26 pc/box 0,50 kg/pc 4 pc/ml

LANDSCAPE - Rigata



100 Tundra

ELEMENTI - Rigata



010 Talco

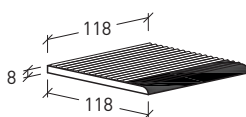

3342 Banda Nera

52 pc/box 0,25 kg/pc 8 pc/ml

LANDSCAPE - Rigata



100 Tundra

ELEMENTI - Rigata



010 Talco

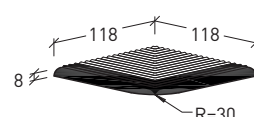

3349 Banda Nera

10 pc/box 0,25 kg/pc

LANDSCAPE - Rigata



100 Tundra

ELEMENTI - Rigata



010 Talco

PINHEAD CON BORDO ARROTONDATO E MARCATURA DI SICUREZZA PINHEAD WITH ROUNDED EDGE AND SECURITY MARKING
 PINHEAD AVEC BORD ARRONDI ET MARQUAGE DE SECURITE PINHEAD MIT GERUNDETE KANTE UND SICHERHEITSMARKIERUNG

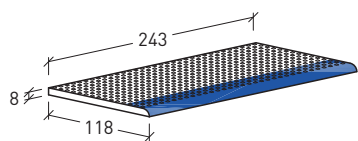

3356 Banda Blu

26 pc/box 0,50 kg/pc 4 pc/ml

ELEMENTI - Pinhead



010 Talco 011 Avorio

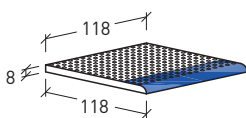

3352 Banda Blu

60 pc/box 0,25 kg/pc 8 pc/ml

ELEMENTI - Pinhead



010 Talco 011 Avorio

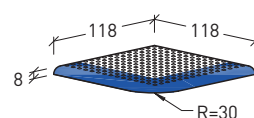

3359 Banda Blu

10 pc/box 0,25 kg/pc

ELEMENTI - Pinhead



010 Talco 011 Avorio

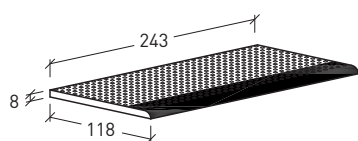

3356 Banda Nera

26 pc/box 0,50 kg/pc 4 pc/ml

ELEMENTI - Pinhead



010 Talco 060 Cemento

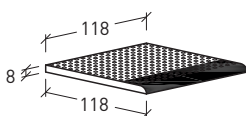

3352 Banda Nera

60 pc/box 0,25 kg/pc 8 pc/ml

ELEMENTI - Pinhead



010 Talco 060 Cemento

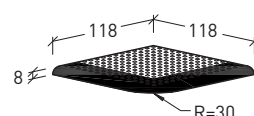

3359 Banda Nera

10 pc/box 0,25kg/pc

ELEMENTI - Pinhead



010 Talco 060 Cemento

ZOCOLO A RACCORDO SMUSSATO BEVELLED COVE BASE PLINTE A GORGE CHANFREINE KEHLSOCKEL MIT SCHIEFER KANTE

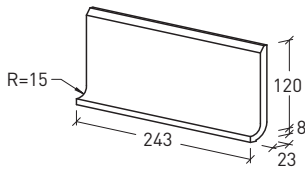
**4100**

26 pc/box 0,60 kg/pc 4 pc/ml

LANDSCAPE - Satin



100 Tundra

ELEMENTI - Matt



010 Talco



011 Avorio



060 Cemento

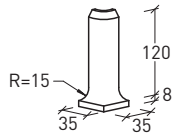

070 Ebano

**4127**

10 pc/box 0,10 kg/pc

LANDSCAPE - Satin



100 Tundra

ELEMENTI - Matt



010 Talco



011 Avorio



060 Cemento

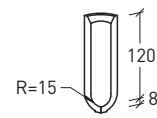

070 Ebano

**4128**

10 pc/box 0,10 kg/pc

LANDSCAPE - Satin



100 Tundra

ELEMENTI - Matt



010 Talco



011 Avorio



060 Cemento



070 Ebano

ZOCOLO A RACCORDO TAGLIO RETTO COVE BASE STRAIGHT TOP PLINTE A GORGE BORD DROIT KEHLSOCKEL SCHARFKANTIG

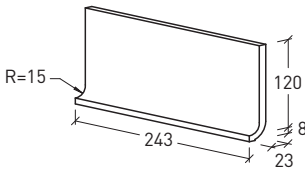
**4200**

26 pc/box 0,60 kg/pc 4 pc/ml

LANDSCAPE - Satin

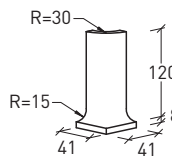

100 Tundra

**4227**

10 pc/box 0,10 kg/pc

LANDSCAPE - Satin

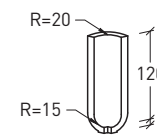

100 Tundra

**4228**

10 pc/box 0,10 kg/pc

LANDSCAPE - Satin



100 Tundra



CANALETTA PIANA CP001 E SCARICO A QUATTRO PENDENZE ANTISCIVOLO NON-SLIP FLAT CHANNEL CP001 AND INDEPENDENT WATER OUTLET CANIVEAU PLAT CP001 ET CUNETTE DE' ECOULEMENT ANTIDERAPANTS NON-SLIP FLACHRINNE CP001 UND FREIES WASSERABLAUF

Vedi pagina: See page: Voir page: Siehe Seite: **69**

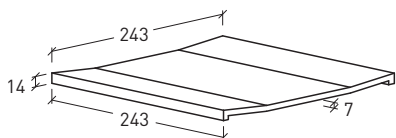

4500

Padana-Deck 8 pc/box 1,10 kg/pc 4 pc/ml

ELEMENTI - Grip*

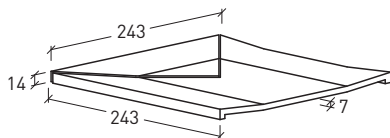

4503

Padana-Deck 8+8 pc/box 1,10 kg/pc

ELEMENTI - Grip*

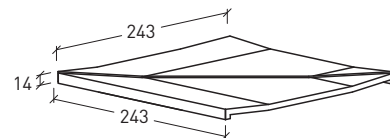

4508

Padana-Deck 2 pc 45° 8+8 pc/box 1,10 kg/pc

ELEMENTI - Grip*

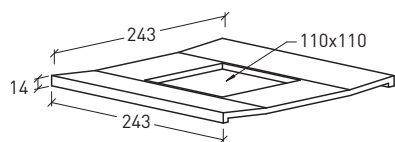

4509

Padana-Deck 8 pc/box 1,00 kg/pc

ELEMENTI - Grip*

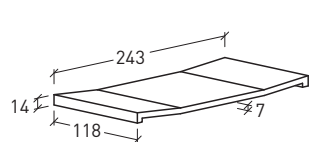

4520

Padana-Deck 16 pc/box 0,60 kg/pc 8 pc/ml

ELEMENTI - Grip*

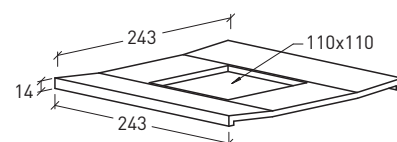

4609

Padana-Deck 8 pc/box 1,00 kg/pc

ELEMENTI - Grip*



* Colori 020 Onda, 021 Mare e 070 Ebano solo su richiesta
 Colours 020 Onda, 021 Mare and 070 Ebano on request only
 Coloris 020 Onda, 021 Mare et 070 Ebano uniquement sur demande
 Farben 020 Onda, 021 Mare und 070 Ebano nur Auf Anfrage

CANALETTE CON GRIGLIE DI COPERTURA CP002 CHANNELS WITH GRATINGS CP002 CANIVEAUX AVEC GRILLES CP002 RINNEN MIT ABDECKROSTE CP002

Vedi pagina: See page: Voir page: Siehe Seite: **70**

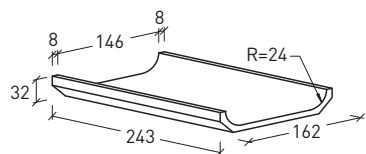

4700

Padana-Deck 10 pc/box 0,80 kg/pc 4 pc/ml

LANDSCAPE - Satin

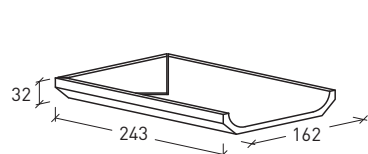

4703

Padana-Deck 5+5 pc/box 0,80 kg/pc

LANDSCAPE - Satin

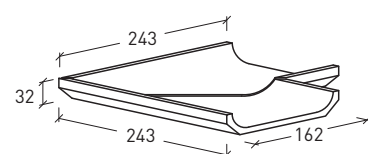

4708

Padana-Deck 2 pc 45° 5+5 pc/box 1,40 kg/pc

LANDSCAPE - Satin

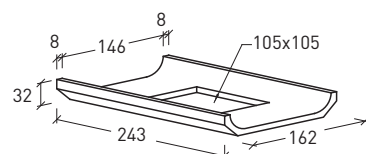

4709

Padana-Deck 10 pc/box 0,70 kg/pc

LANDSCAPE - Satin

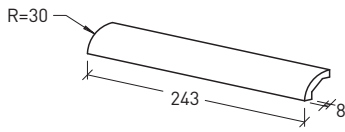

COPRI SPIGOLI QUARTER ROUNDS QUARTS DE ROND RADIALLEISTEN

**5630**

48 pc/box 0,20 kg/pc 4 pc/ml

LANDSCAPE - Satin

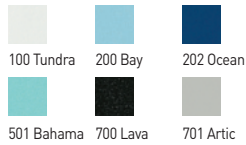

LANDSCAPE - Grip

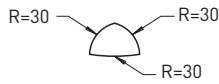

ELEMENTI - Matt

**5607**

10 pc/box 0,05 kg/pc

LANDSCAPE - Satin

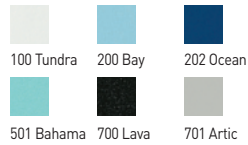

LANDSCAPE - Grip

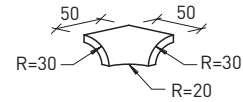

ELEMENTI - Matt

**5608**

10 pc/box 0,06 kg/pc

LANDSCAPE - Satin

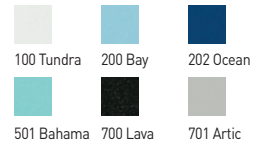

ELEMENTI - Matt

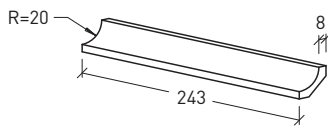

SGUSCIETTE COVES GORGES HOHLKEHLEN

**5730**

48 pc/box 0,20 kg/pc 4 pc/ml

LANDSCAPE - Satin

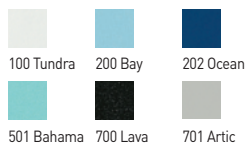

ELEMENTI - Matt

**5603**

10 pc/box 0,05 kg/pc

LANDSCAPE - Satin

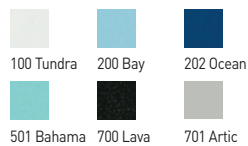

ELEMENTI - Matt

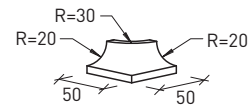
**5604**

10 pc/box 0,06 kg/pc

LANDSCAPE - Satin

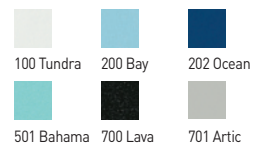

ELEMENTI - Matt



BORDO WIESBADEN A PARETE E BORDO SKIMMER WIESBADEN LOW-LEVEL AND SKIMMER
PIÈCE DE BORDURE WIESBADEN EN PAROI ET SKIMMER BECKENRANDSTEIN WIESBADEN TIEFLIEGEND UND SKIMMER

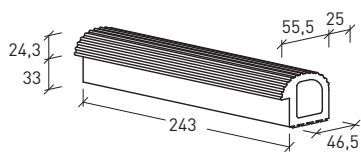

6050

Trim-Box 8 pc/box 0,80 kg/pc 4 pc/ml

ELEMENTI - Rigata

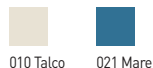

010 Talco 021 Mare

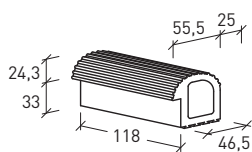

6020

Trim-Box 16 pc/box 0,40 kg/pc 8 pc/ml

ELEMENTI - Rigata



010 Talco 021 Mare

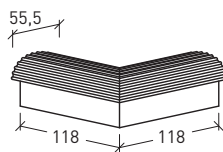

6057

Trim-Box 2 pc 45° 4+4 pc/box 0,80 kg/pc

ELEMENTI - Rigata

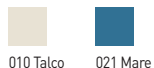

010 Talco 021 Mare

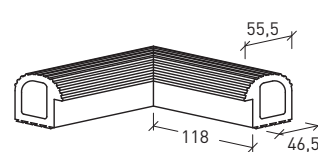

6058

Trim-Box 2 pc 45° 4+4 pc/box 0,80 kg/pc

ELEMENTI - Rigata



010 Talco 021 Mare

P104-0242

Polyfill profilo / profile / profil / Profil

(1 pc)*

P105-0117

Polyfill profilo / profile / profil / Profil

(1 pc)*

* Vedi pagina: See page: Voir page: Siehe Seite: 42

SUPPORTO BETONBUILD PER WIESBADEN A PARETE CEMENTITIOUS SUPPORT BETONBUILD FOR WIESBADEN LOW-LEVEL
SUPPORT EN BETON BETONBUILD POUR WIESBADEN EN PAROI TRÄGERELEMENT BETONBUILD FÜR WIESBADEN TIEFLIEGEND

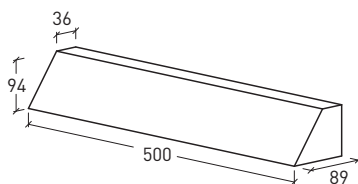

6315

Betonbuild 12,00 kg/pc 2 pc/ml

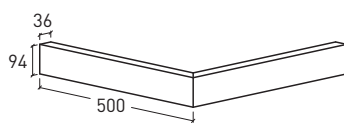

6317

Betonbuild 2 pc 45° 24,00 kg/pc

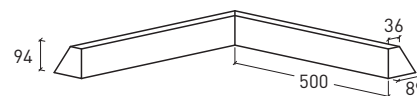

6318

Betonbuild 2 pc 45° 24,00 kg/pc

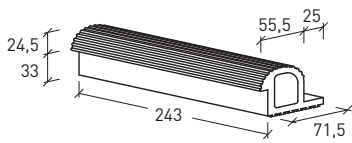

**BORDO WIESBADEN A PAVIMENTO POOL BORDER WIESBADEN HIGH-LEVEL PIÈCE DE BORDURE WIESBADEN SURFLÖT
BECKENRANDSTEIN WIESBADEN HOCHLIEGEND**

**6550**

Trim-Box 8 pc/box 0,80 kg/pc 4 pc/ml

ELEMENTI - Rigata

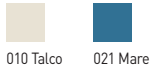

010 Talco 021 Mare

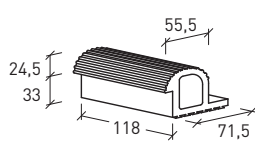
**6520**

Trim-Box 16 pc/box 0,40 kg/pc 8 pc/ml

ELEMENTI - Rigata

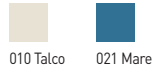

010 Talco 021 Mare

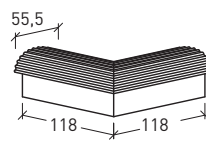
**6557**

Trim-Box 2 pc 45° 4+4 pc/box 0,80 kg/pc

ELEMENTI - Rigata

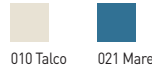

010 Talco 021 Mare

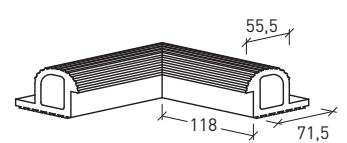
**6558**

Trim-Box 2 pc 45° 4+4 pc/box 0,80 kg/pc

ELEMENTI - Rigata

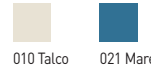

010 Talco 021 Mare

P104-0242

Polyfill profilo / profile / profil / Profil

(1 pc)*

P105-0117

Polyfill profilo / profile / profil / Profil

(1 pc)*

* Vedi pagina: See page: Voir page: Siehe Seite: 42

**SUPPORTO BETONBUILD PER WIESBADEN A PAVIMENTO CEMENTITIOUS SUPPORT BETONBUILD FOR WIESBADEN HIGH-LEVEL
SUPPORT EN BETON BETONBUILD POUR WIESBADEN SURFLÖT TRÄGERELEMENT BETONBUILD FÜR WIESBADEN HOCHLIEGEND**

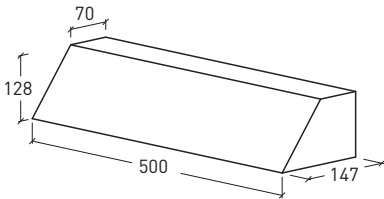
**6415**

Betonbuild 16,00 kg/pc 2 pc/ml

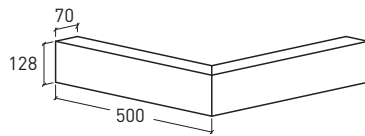
**6417**

Betonbuild 2 pc 45° 32,00 kg/pc

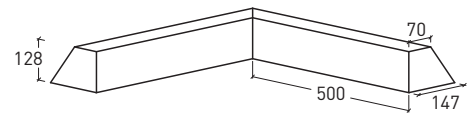
**6418**

Betonbuild 2 pc 45° 32,00 kg/pc



CANALETTA MONOLITICA WIESBADEN MONOLITHIC WIESBADEN CHANNEL GOULOTTE WIESBADEN MONOLITHIQUE MONOLITISCHE RINNE WIESBADEN

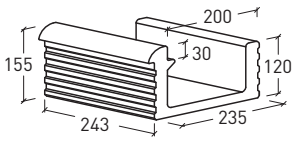

6600

1 pc/box 7,00 kg/pc 4 pc/ml

LANDSCAPE - Satin



100 Tundra

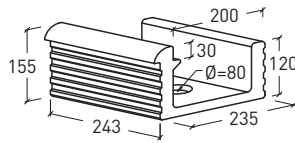

6609

1 pc/box 7,00 kg/pc

LANDSCAPE - Satin



100 Tundra

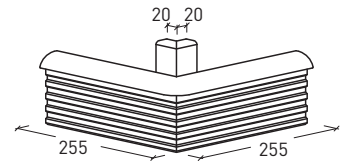

6607

2 pc 45° 1+1 pc/box 10,00 kg/pc

LANDSCAPE - Satin



100 Tundra

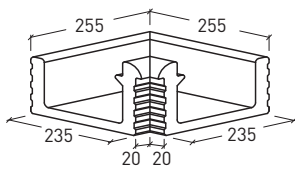

6608

2 pc 45° 1+1 pc/box 10,00 kg/pc

LANDSCAPE - Satin



100 Tundra

BORDO FINLANDESE RIGATA FINNISH POOL BORDER RIBBED TETE DE BASSIN FINLANDAISE STRIEE BECKENKOPF FINNLAND MIT RILLEN

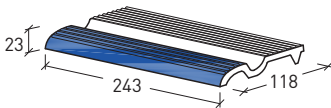

7200 Banda Blu

10 pc/box 0,90 kg/pc 4 pc/ml

LANDSCAPE - Rigata



100 Tundra

ELEMENTI - Rigata



010 Talco 011 Avorio

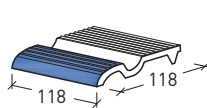

7220 Banda Blu

20 pc/box 0,45 kg/pc 8 pc/ml

LANDSCAPE - Rigata



100 Tundra

ELEMENTI - Rigata



010 Talco 011 Avorio

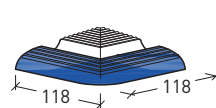

7207 Banda Blu

2 pc 45° 4+4 pc/box 0,40 kg/pc

LANDSCAPE - Rigata



100 Tundra

ELEMENTI - Rigata



010 Talco 011 Avorio

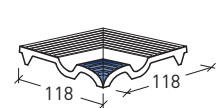

7208 Banda Blu

2 pc 45° 4+4 pc/box 0,40 kg/pc

LANDSCAPE - Rigata



100 Tundra

ELEMENTI - Rigata



010 Talco 011 Avorio

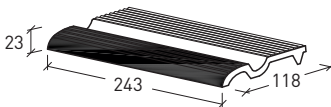

7200 Banda Nera

10 pc/box 0,90 kg/pc 4 pc/ml

LANDSCAPE - Rigata



100 Tundra

ELEMENTI - Rigata



010 Talco

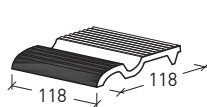

7220 Banda Nera

20 pc/box 0,45 kg/pc 8 pc/ml

LANDSCAPE - Rigata



100 Tundra

ELEMENTI - Rigata



010 Talco

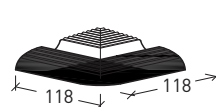

7207 Banda Nera

2 pc 45° 4+4 pc/box 0,40 kg/pc

LANDSCAPE - Rigata



100 Tundra

ELEMENTI - Rigata



010 Talco

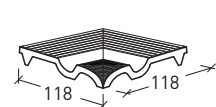

7208 Banda Nera

2 pc 45° 4+4 pc/box 0,40 kg/pc

LANDSCAPE - Rigata



100 Tundra

ELEMENTI - Rigata



010 Talco

BORDO FINLANDESE PINHEAD FINNISH POOL BORDER PINHEAD TETE DE BASSIN FINLANDAISE PINHEAD BECKENKOPF FINNLAND PINHEAD

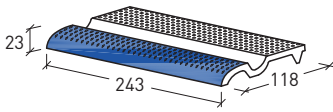
**7300 Banda Blu**

10 pc/box 0,90 kg/pc 4 pc/ml

ELEMENTI - Pinhead

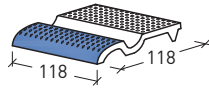

010 Talco 011 Avorio

**7320 Banda Blu**

20 pc/box 0,45 kg/pc 8 pc/ml

ELEMENTI - Pinhead

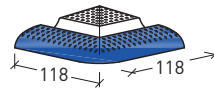

010 Talco 011 Avorio

**7307 Banda Blu**

2 pc 45° 4+4 pc/box 0,40 kg/pc

ELEMENTI - Pinhead

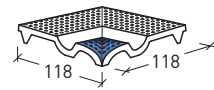

010 Talco 011 Avorio

**7308 Banda Blu**

2 pc 45° 4+4 pc/box 0,40 kg/pc

ELEMENTI - Pinhead

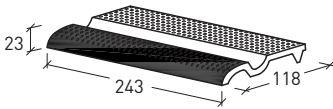

010 Talco 011 Avorio

**7300 Banda Nera**

10 pc/box 0,90 kg/pc 4 pc/ml

ELEMENTI - Pinhead

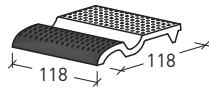

010 Talco 060 Cemento

**7320 Banda Nera**

20 pc/box 0,45 kg/pc 8 pc/ml

ELEMENTI - Pinhead

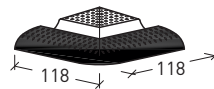

010 Talco 060 Cemento

**7307 Banda Nera**

2 pc 45° 4+4 pc/box 0,40 kg/pc

ELEMENTI - Pinhead

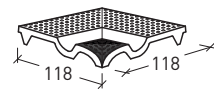

010 Talco 060 Cemento

**7308 Banda Nera**

2 pc 45° 4+4 pc/box 0,40 kg/pc

ELEMENTI - Pinhead

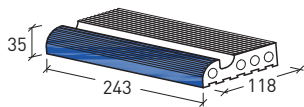

010 Talco 060 Cemento

BORDO FINLANDESE TRIM-BOX CON AGGRAPPO E BANDA DI SICUREZZA FINNISH POOL BORDER TRIM-BOX WITH FINGER GRIP AND SECURITY MARKING
PIÈCE DE BORDURE FINLANDAISE TRIM-BOX AVEC ACCROCHE DOIGTS ET BANDE DE SÉCURITÉ BECKENRANDSTEIN FINNLAND TRIM-BOX MIT HANDFASS
UND SICHERHEITSMARKIERUNG**7500 Banda Blu**

Trim-Box 6 pc/box 1,60 kg/pc 4 pc/ml

LANDSCAPE - Rigata



100 Tundra

ELEMENTI - Rigata

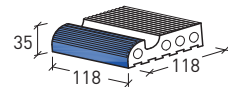

010 Talco

**7520 Banda Blu**

Trim-Box 12 pc/box 0,80 kg/pc 8 pc/ml

LANDSCAPE - Rigata



100 Tundra

ELEMENTI - Rigata

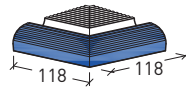

010 Talco

**7507 Banda Blu**

Trim-Box 2 pc 45° 6+6 pc/box 0,80 kg/pc

LANDSCAPE - Rigata



100 Tundra

ELEMENTI - Rigata

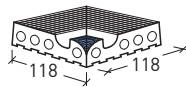

010 Talco

**7508 Banda Blu**

Trim-Box 2 pc 45° 6+6 pc/box 0,80 kg/pc

LANDSCAPE - Rigata



100 Tundra

ELEMENTI - Rigata

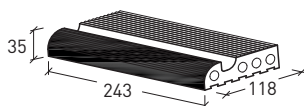

010 Talco

P106-0242Polyfill cilindro / cylinder / cilindre / Zylinder
(4 pcs)***7500 Banda Nera**

Trim-Box 6 pc/box 1,60 kg/pc 4 pc/ml

LANDSCAPE - Rigata



100 Tundra

ELEMENTI - Rigata

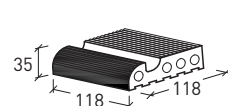

010 Talco

**7520 Banda Nera**

Trim-Box 12 pc/box 0,80 kg/pc 8 pc/ml

LANDSCAPE - Rigata



100 Tundra

ELEMENTI - Rigata

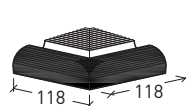

010 Talco

**7507 Banda Nera**

Trim-Box 2 pc 45° 6+6 pc/box 0,80 kg/pc

LANDSCAPE - Rigata



100 Tundra

ELEMENTI - Rigata

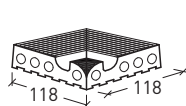

010 Talco

**7508 Banda Nera**

Trim-Box 2 pc 45° 6+6 pc/box 0,80 kg/pc

LANDSCAPE - Rigata



100 Tundra

ELEMENTI - Rigata



010 Talco

P106-0242Polyfill cilindro / cylinder / cilindre / Zylinder
(4 pcs)***P107-0117**Polyfill cilindro / cylinder / cilindre / Zylinder
(4 pcs)*

BORDO FINLANDESE TRIM-BOX CON AGGRAPPO, BANDA DI SICUREZZA E SUPPORTO GRIGLIA FINNISH POOL BORDER TRIM-BOX WITH FINGER GRIP, SECURITY MARKING AND SUPPORT FOR GRATING PIÈCE DE BORDURE FINLANDAISE TRIM-BOX AVEC ACCROCHE DOIGTS, BANDE DE SÉCURITÉ ET SUPPORT DE GRILLE BECKENRANDSTEIN FINNLAND TRIM-BOX MIT HANDFASS, SICHERHEITSMARKIERUNG UND ROSTTRÄGER

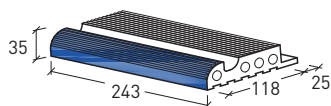

7800 Banda Blu

Trim-Box 7 pc/box 1,80kg/pc 4 pc/ml

LANDSCAPE - Rigata



100 Tundra

ELEMENTI - Rigata



010 Talco

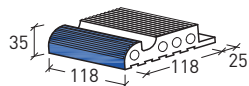

7820 Banda Blu

Trim-Box 14 pc/box 0,90 kg/pc 8 pc/ml

LANDSCAPE - Rigata



100 Tundra

ELEMENTI - Rigata



010 Talco

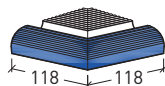

7807 Banda Blu

Trim-Box 2 pc 45° 7+7 pc/box 0,90kg/pc

LANDSCAPE - Rigata



100 Tundra

ELEMENTI - Rigata



010 Talco

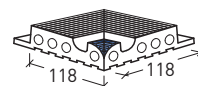

7808 Banda Blu

Trim-Box 2 pc 45° 7+7 pc/box 0,90kg/pc

LANDSCAPE - Rigata



100 Tundra

ELEMENTI - Rigata



010 Talco

P106-0242

Polyfill cilindro / cylinder / cilindre / Zylinder

(4 pcs)*

P107-0117

Polyfill cilindro / cylinder / cilindre / Zylinder

(4 pcs)*

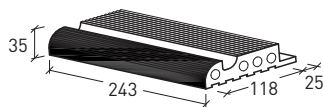

7800 Banda Nera

Trim-Box 7 pc/box 1,80kg/pc 4 pc/ml

LANDSCAPE - Rigata



100 Tundra

ELEMENTI - Rigata



010 Talco

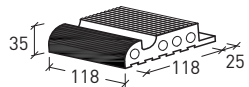

7820 Banda Nera

Trim-Box 14 pc/box 0,90 kg/pc 8 pc/ml

LANDSCAPE - Rigata



100 Tundra

ELEMENTI - Rigata



010 Talco

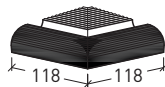

7807 Banda Nera

Trim-Box 2 pc 45° 7+7 pc/box 0,90kg/pc

LANDSCAPE - Rigata



100 Tundra

ELEMENTI - Rigata



010 Talco

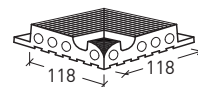

7808 Banda Nera

Trim-Box 2 pc 45° 7+7 pc/box 0,90kg/pc

LANDSCAPE - Rigata



100 Tundra

ELEMENTI - Rigata



010 Talco

P106-0242

Polyfill cilindro / cylinder / cilindre / Zylinder

(4 pcs)*

P107-0117

Polyfill cilindro / cylinder / cilindre / Zylinder

(4 pcs)*

* Vedi pagina: See page: Voir page: Siehe Seite: 42

BORDO FINLANDESE LARGO TRIM-BOX: PEZZO CON AGGRAPPO LARGO CON MARCATURA DI SICUREZZA E SUPPORTO GRIGLIA LARGE FINNISH POOL
BORDER TRIM-BOX: LARGE FINGER GRIP WITH SECURITY MARKING AND GRID SUPPORT TETE DE BASSIN FINLANDAISE LARGE TRIM-BOX: ACCROCHE
DOIGTS LARGE AVEC MARQUAGE DE SECURITE ET SUPPORT DE GRILLE GRÖSSE BECKENKOPF FINNLAND TRIM-BOX: GRÖSSE HAND FASS-STEIN MIT
SICHERHEITSMARKIERUNG UND ROSTAUFLAGEWINKEL

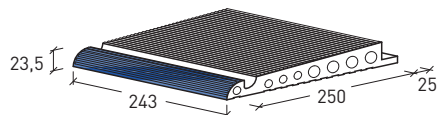
**7700 Banda Blu**

Trim-Box 5 pc/box 3,20 kg/pc

ELEMENTI - Rigata

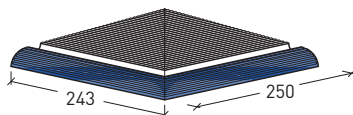

010 Talco

**7707 Banda Blu**

Trim-Box 2 pc 45° 2+2 pc/box 3,20 kg/pc

ELEMENTI - Rigata

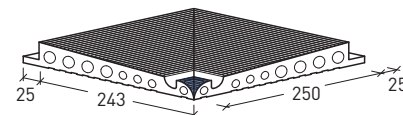

010 Talco

**7708 Banda Blu**

Trim-Box 2 pc 45° 2+2 pc/box 3,20 kg/pc

ELEMENTI - Rigata



010 Talco

P213-0242

Polyfill cilindro / cylinder / cilindre / Zylinder

(4 pcs)*

P106-0242

Polyfill cilindro / cylinder / cilindre / Zylinder

(4 pcs)*

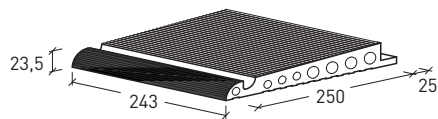
**7700 Banda Nera**

Trim-Box 5 pc/box 3,20 kg/pc

ELEMENTI - Rigata

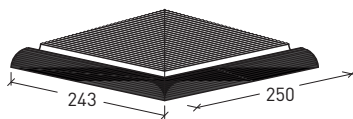

010 Talco

**7707 Banda nera**

Trim-Box 2 pc 45° 2+2 pc/box 3,20 kg/pc

ELEMENTI - Rigata

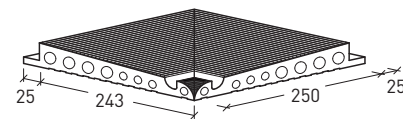

010 Talco

**7708 Banda Nera**

Trim-Box 2 pc 45° 2+2 pc/box 3,20 kg/pc

ELEMENTI - Rigata



010 Talco

P213-0242

Polyfill cilindro / cylinder / cilindre / Zylinder

(4 pcs)*

P106-0242

Polyfill cilindro / cylinder / cilindre / Zylinder

(4 pcs)*

* Vedi pagina: See page: Voir page: Siehe Seite: 42

BORDO FINLANDESE TRIM-BOX: PEZZO DI RACCORDO FINNISH POOL BORDER TRIM-BOX: CONNECTION PIECE TETE DE BASSIN FINLANDAISE TRIM-BOX: PIÈCE DE RACCORD BECKENKOPF FINNLAND TRIM-BOX: FORTFUEHRUNGSTUECK

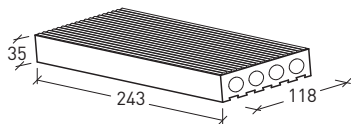

8100

Trim-Box 6 pc/box 1,60 kg/pc 4 pc/ml

LANDSCAPE - Rigata



100 Tundra

ELEMENTI - Rigata



010 Talco

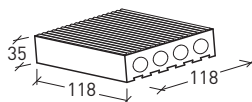

8120

Trim-Box 12 pc/box 0,80 kg/pc 8 pc/ml

LANDSCAPE - Rigata



100 Tundra

ELEMENTI - Rigata



010 Talco

P102-0242

Polyfill cilindro / cylinder / cilindre / Zylinder

(4 pcs)*

P103-0117

Polyfill cilindro / cylinder / cilindre / Zylinder

(4 pcs)*

BORDO FINLANDESE TRIM-BOX: PEZZO DI RACCORDO CON SUPPORTO GRIGLIA FINNISH POOL BORDER TRIM-BOX: CONNECTION PIECE WITH GRID SUPPORT TETE DE BASSIN FINLANDAISE TRIM-BOX: PIÈCE DE RACCORD AVEC SUPPORT DE GRILLE BECKENKOPF FINNLAND TRIM-BOX: FORTFUEHRUNGSTUECK MIT ROSTAUFLAGEWINKEL

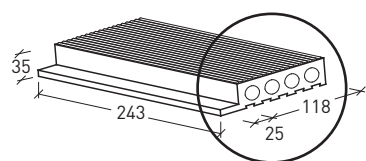

8600

Trim-Box 7 pc/box 1,80 kg/pc 4 pc/ml

LANDSCAPE - Rigata



100 Tundra

ELEMENTI - Rigata



010 Talco

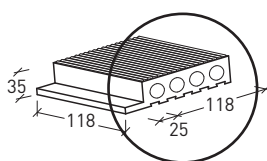

8620

Trim-Box 14 pc/box 0,90 kg/pc 8 pc/ml

LANDSCAPE - Rigata



100 Tundra

ELEMENTI - Rigata



010 Talco

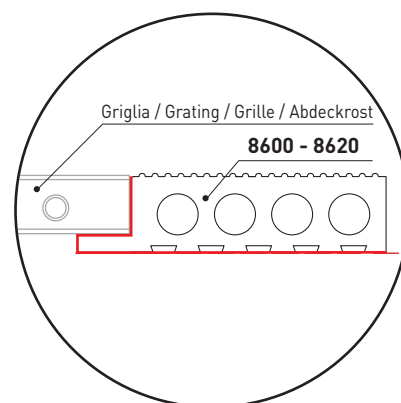

P102-0242

Polyfill cilindro / cylinder / cilindre / Zylinder

(4 pcs)*

P103-0117

Polyfill cilindro / cylinder / cilindre / Zylinder

(4 pcs)*

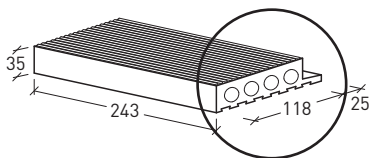

8800

Trim-Box 7 pc/box 1,80 kg/pc 4 pc/ml

LANDSCAPE - Rigata



100 Tundra

ELEMENTI - Rigata



010 Talco

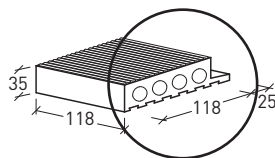

8820

Trim-Box 14 pc/box 0,90 kg/pc 8 pc/ml

LANDSCAPE - Rigata



100 Tundra

ELEMENTI - Rigata



010 Talco

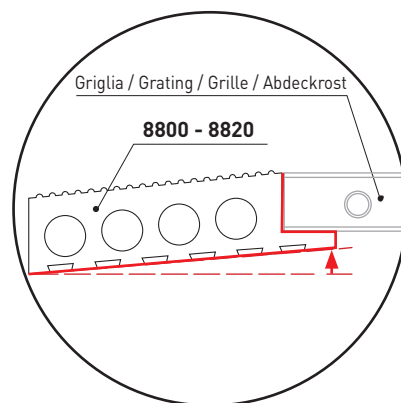

P102-0242

Polyfill cilindro / cylinder / cilindre / Zylinder

(4 pcs)*

P103-0117

Polyfill cilindro / cylinder / cilindre / Zylinder

(4 pcs)*

* Vedi pagina: See page: Voir page: Siehe Seite: 42

BORDO FINLANDESE TRIM-BOX: PEZZO ARROTONDATO "CON E SENZA SUPPORTO GRIGLIA" E "CON E SENZA MARCATURA DI SICUREZZA" FINNISH POOL BORDER TRIM-BOX: ROUNDED PIECE "WITH AND WITHOUT GRID SUPPORT" AND "WITH AND WITHOUT SECURITY MARKING" TÊTE DE BASSIN FINLANDAISE TRIM-BOX: PIÈCE ARRONDIE "AVEC ET SANS SUPPORT DE GRILLE" ET "AVEC ET SANS MARQUAGE DE SECURITÉ" BECKENKOPF FINNLAND TRIM-BOX: GERUNDETE STUECK "MIT UND OHNE ROSTAUFLAGEWINKEL" UND "MIT UND OHNE SICHERHEITSMARKIERUNG"

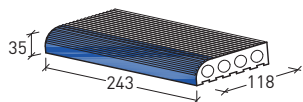

9046 Banda Blu

Trim-Box 6 pc/box 1,50 kg/pc 4 pc/ml

LANDSCAPE - Rigata



100 Tundra

ELEMENTI - Rigata



010 Talco

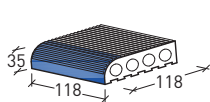

9042 Banda Blu

Trim-Box 12 pc/box 0,75 kg/pc 8 pc/ml

LANDSCAPE - Rigata



100 Tundra

ELEMENTI - Rigata



010 Talco

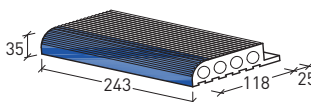

9546 Banda Blu

Trim-Box 7 pc/box 1,60 kg/pc 4 pc/ml

LANDSCAPE - Rigata



100 Tundra

ELEMENTI - Rigata



010 Talco

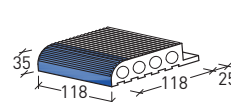

9542 Banda Blu

Trim-Box 14 pc/box 0,80 kg/pc 8 pc/ml

LANDSCAPE - Rigata



100 Tundra

ELEMENTI - Rigata



010 Talco

P102-0242

Polyfill cilindro / cylinder / cilindre / Zylinder
(4 pcs)*

P103-0117

Polyfill cilindro / cylinder / cilindre / Zylinder
(4 pcs)*

P102-0242

Polyfill cilindro / cylinder / cilindre / Zylinder
(4 pcs)*

P103-0117

Polyfill cilindro / cylinder / cilindre / Zylinder
(4 pcs)*

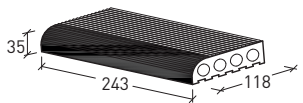

9046 Banda Nera

Trim-Box 6 pc/box 1,50 kg/pc 4 pc/ml

LANDSCAPE - Rigata



100 Tundra

ELEMENTI - Rigata



010 Talco

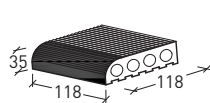

9042 Banda Nera

Trim-Box 12 pc/box 0,75 kg/pc 8 pc/ml

LANDSCAPE - Rigata



100 Tundra

ELEMENTI - Rigata



010 Talco

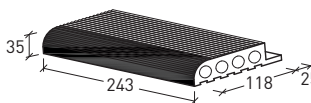

9546 Banda Nera

Trim-Box 7 pc/box 1,60 kg/pc 4 pc/ml

LANDSCAPE - Rigata



100 Tundra

ELEMENTI - Rigata



010 Talco

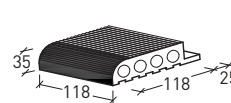

9542 Banda Nera

Trim-Box 14 pc/box 0,80 kg/pc 8 pc/ml

LANDSCAPE - Rigata



100 Tundra

ELEMENTI - Rigata



010 Talco

P102-0242

Polyfill cilindro / cylinder / cilindre / Zylinder
(4 pcs)*

P103-0117

Polyfill cilindro / cylinder / cilindre / Zylinder
(4 pcs)*

P102-0242

Polyfill cilindro / cylinder / cilindre / Zylinder
(4 pcs)*

P103-0117

Polyfill cilindro / cylinder / cilindre / Zylinder
(4 pcs)*

PIASTRELLE DI INDICAZIONE MARKING TILES CARREAUX NUMEROTES ANZEIGEFLEISEN

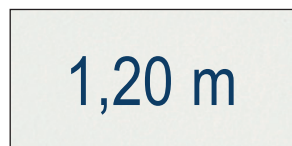

D400 100S
M12,5x25 cm
Tundra Satin - Ocean Satin*

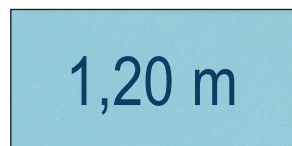

D400 200S
M12,5x25 cm
Bay Satin - Ocean Satin*



D440 100S (2 pz)
M12,5x25 cm
Tundra Satin - Ocean Satin*

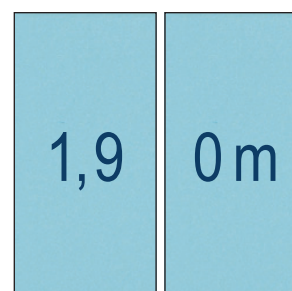

D440 200S (2 pz)
M12,5x25 cm
Bay Satin - Ocean Satin*

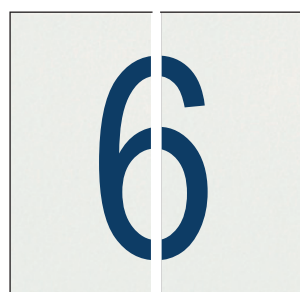

D480 100S (2 pz)
M12,5x25 cm
Tundra Satin - Ocean Satin*

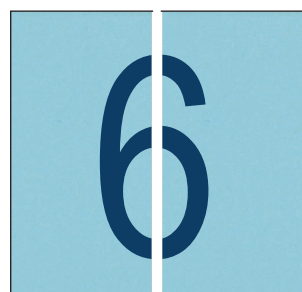

D480 200S (2 pz)
M12,5x25 cm
Bay Satin - Ocean Satin*

DETTAGLI DETAILS DÉTAILS DETAILS

Carattere Arial Narrow

Font Arial Narrow - Caractère Arial Narrow - Schrifttyp Arial Narrow

Altezza carattere 7 cm

Font height 7 cm - Hauteur du caractère 7 cm - Schrifthöhe 7 cm

Spessore carattere 7 mm

Font width 7 mm - Dimension du caractère 7 mm - Schriftdicke 7 mm

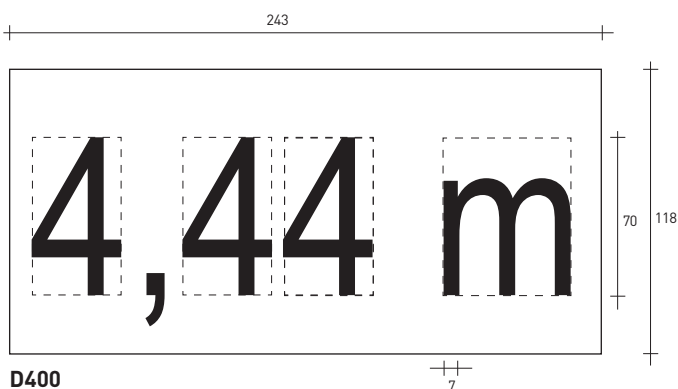

D400

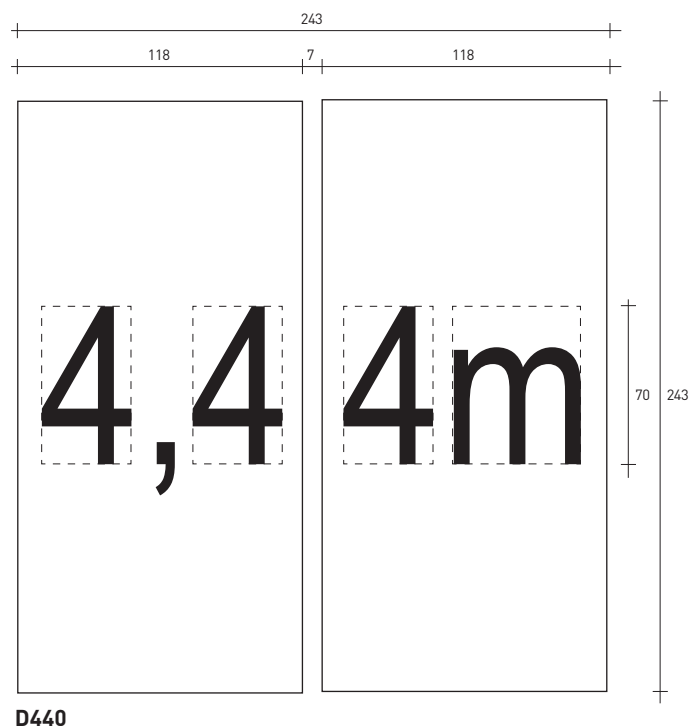

D440

Le piastrelle di indicazione sono ottenute per lavorazione con inserto a contrasto.
Marking tiles are obtained through machining with insert of contrasting colour.
Les carreaux de profondeur sont obtenus par usinage avec chiffres et lettres de couleur contrasté.
Anzeigefliesen sind mit Verarbeitung. Die Nummern und Buchstaben sind mit Kontrastfarbe.

* A richiesta, altri colori e superfici On request, other colours and surfaces Sur demande, autres couleurs et finitions: Auf Anfrage auch andere Farben und Oberflächen



Padana Grid griglie e accessori

GRATINGS AND ACCESSORIES
GRILLES ET ACCESSOIRES
ROSTE UND ZUBEHÖR

Il progetto di una piscina o impianto natatorio è estremamente complesso e la sua realizzazione vede spesso, accanto ai materiali ceramici, anche accessori di natura diversa che però devono essere installati contemporaneamente alla posa delle ceramiche.

E' proprio per dare un servizio completo e consentire la realizzazione integrale di taluni elementi costruttivi che è stata realizzata questa sezione dedicata agli accessori più standard utilizzati solitamente nelle piscine.

Designing a pool or swimming facility is a very complex activity and will most often include, next to ceramic materials, the use of other accessories of various nature, which might be installed simultaneously with the tiles.

This section has been specially dedicated to standard pool accessories in this respect and in order to provide a complete service while carrying out all the architectural elements.

Le projet d'une piscine ou d'une installation de natation est très complexe et sa réalisation prévoit très souvent le recours à des accessoires divers, à installer normalement lors de la pose de l'habillage céramique.

A cet égard et dans le but de fournir un service complet en mesure de réaliser l'ensemble des éléments architecturaux, la présente section a été spécialement conçue et dédiée aux accessoires standards pour piscines.

Das Projekt eines Schwimmbeckens oder einer Schwimmanlage ist äußerst komplex und seine Umsetzung erfordert oft, nebst den Keramikmaterialien, Zuberhörteile verschiedener Art, die jedoch gleichzeitig zur Verlegung der Keramik installiert werden müssen.

Zugunsten einer umfassenden Dienstleistung und für eine komplette Ausführung dieser Bauteile wurde dieser Bereich eingerichtet, der dem normalerweise in den Schwimmbädern verwendeten standardmäßigen Zubehör gewidmet ist.

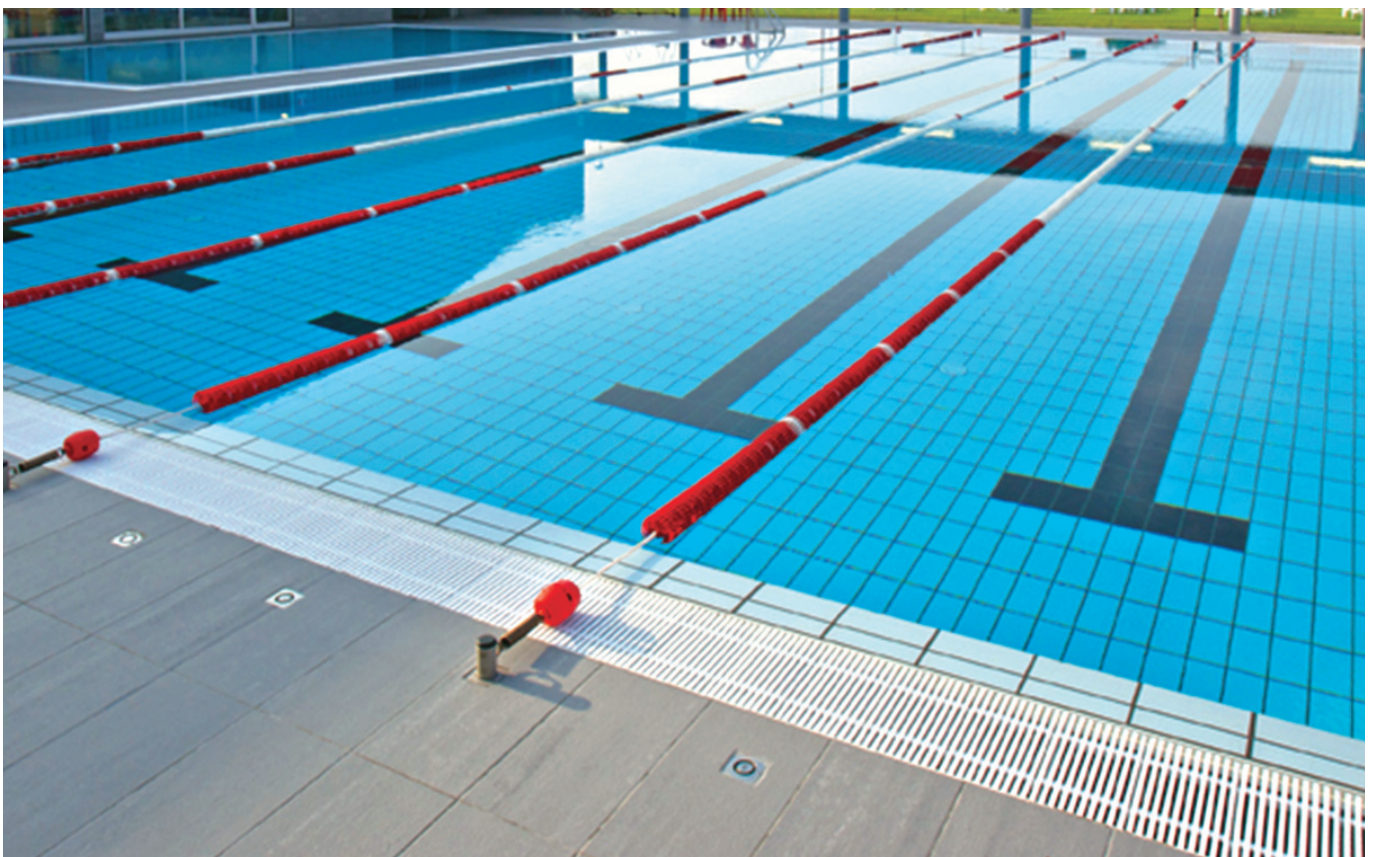

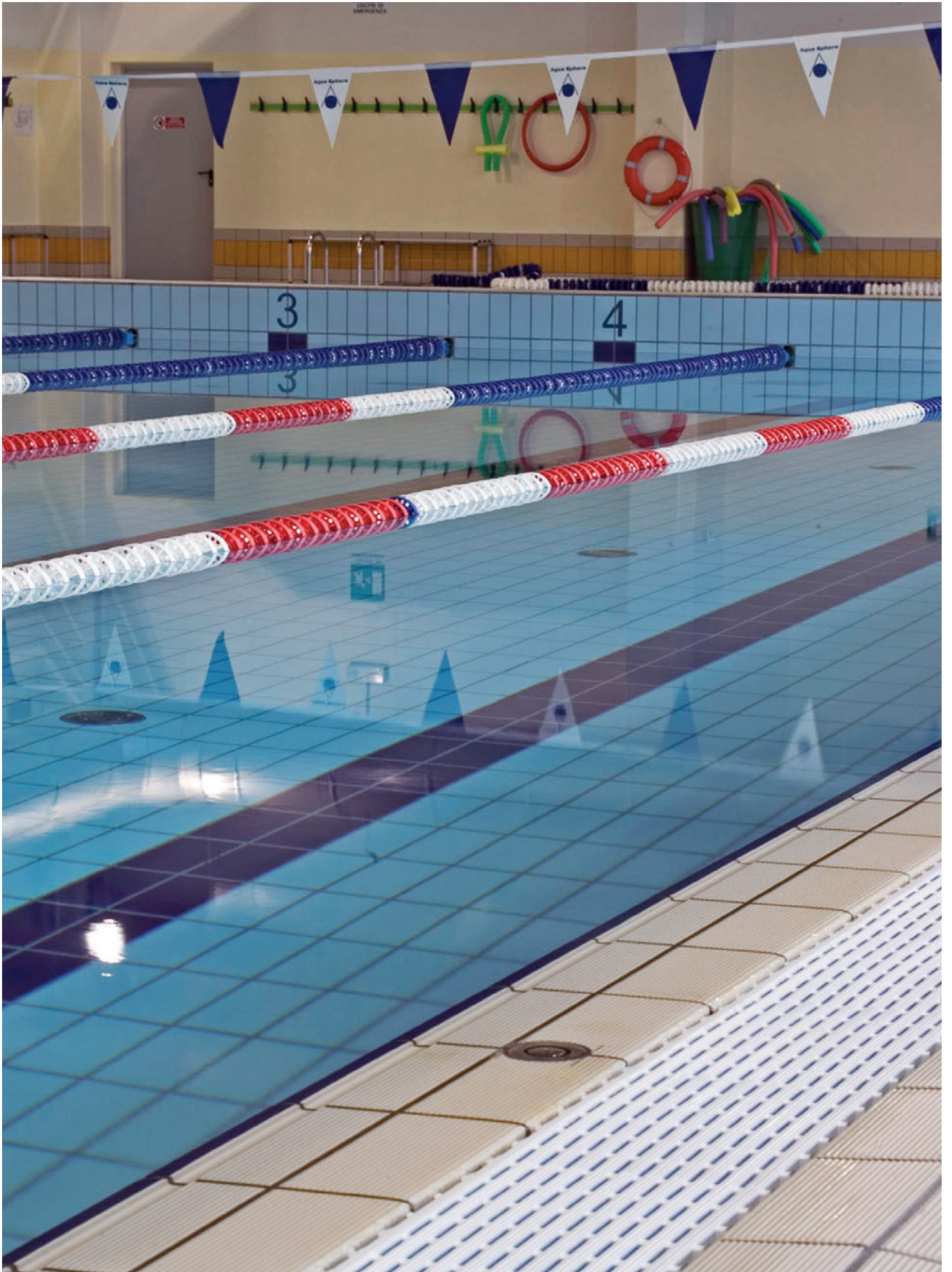

GRIGLIE PER PISCINE GRATINGS FOR SWIMMING POOL GRILLES POUR PISCINES GRILLES POUR PISCINES

Sono realizzate in materiale plastico di prima qualità, non assorbenti, resistenti all'attacco degli agenti chimici, alla luce e ai raggi UV, con il necessario grado di antiscivolosità a piedi nudi e una distanza massima fra le singole stecche di 8 mm, come richiesto dalla norma EN 13451/3.

They are made with high-quality plastic, they are non-absorbent, chemical, light and UV resistant, with the necessary barefoot anti-slip grade and maximum distance between the rods equal to 8 mm, as defined in EN 13451/3.

Sont réalisées en matière plastique haut de gamme, non absorbantes, résistantes aux agents chimiques, à la lumière et aux rayons UV, avec classement antidérapant pieds nus et distance maximum entre les baguettes égale à 8 mm, au sens de la norme EN 13451/3.

Sie sind aus erstklassigem Kunststoffmaterial hergestellt, sind nicht saugfähig, sind beständig gegen Chemikalien, Licht und UV-Strahlen, weisen den erforderlichen Rutschfestigkeitskoeffizienten bei barfüßigem Betreten auf und haben einen Höchstabstand zwischen den einzelnen Stäben von 8 mm, entsprechend den Vorgaben der Norm EN 13451/3.

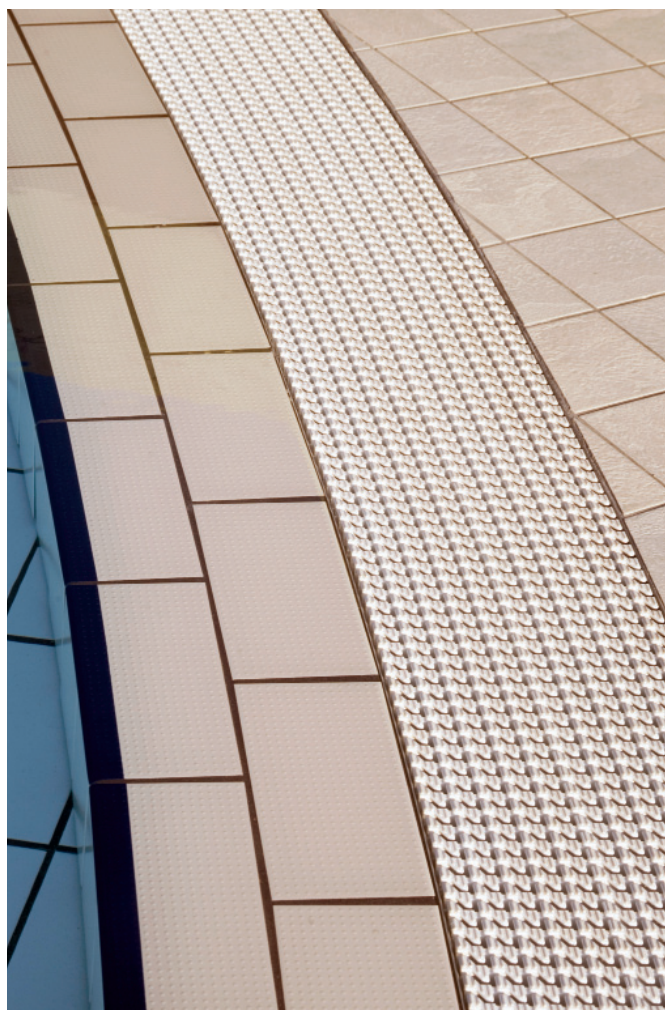
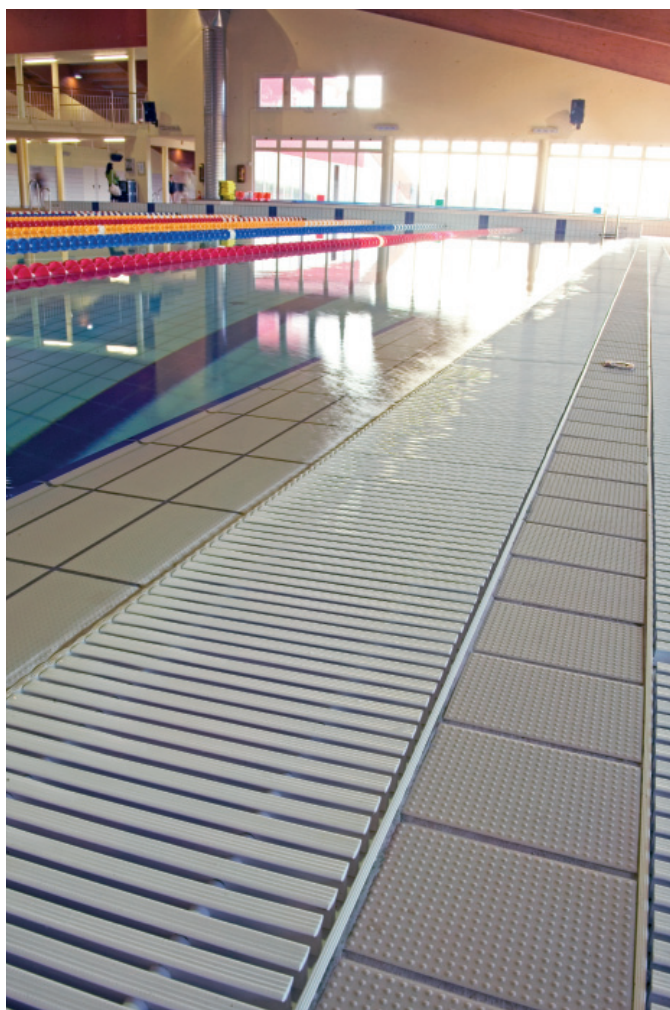

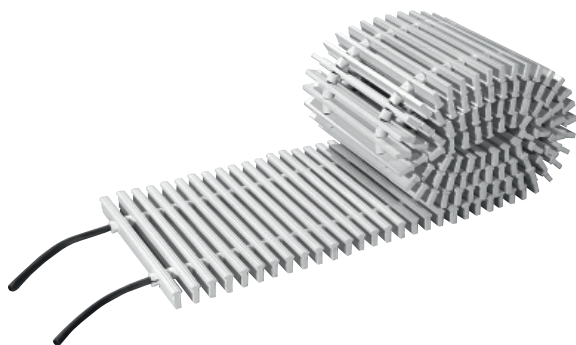

Mod. GPAL

Padana-Grid

Griglia perpendicolare, arrotolabile, lineare
Perpendicular roll-up linear gratings
Grille perpendiculaire, enroulable, linéaire
Rechtwinkliges, aufrollbares, lineares Abdeckrost

Codice griglia Item code Code grille Rostcode	Larghezza Width Largeur Rostbreite	Peso Weight Poids Gewicht	Spessore Thickness Epaisseur Stärke	Colore Colour Couleur Farbe
GPAL-180B	180 mm	3 kg	25 mm	Bianco (B) White (B) Blanc (B) Weiß (B)
GPAL-200B	200 mm	3,3 kg		
GPAL-250B	250 mm	4,1 kg		
GPAL-330B	330 mm	5,4 kg		

Larghezza minima 180 mm. Elementi standard 2,50 metri. Altri colori e larghezze a richiesta. A richiesta può essere fornita curvata a disegno. Minimum width 180 mm. Standard elements 2,50 meters. Other colours and widths on demand. On demand we can supply this model curved. Largeur minimale 180 mm. Elements standard 2,50 mètres. Autres largeurs et couleurs sur demande. Sur demande ce modèle est disponible curvée sur mesure. Minimale Breite 180 mm. Geliefert in Stücke von 2,50 Metern. Andere Breite und Farben auf Anfrage. Auf Anfrage dieses Modell kann gerundet geliefert sein.

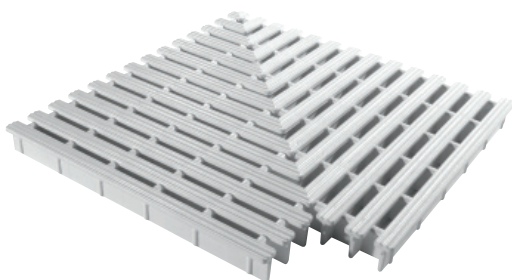

Mod. GAPP

Padana-Grid

Angolo a 90° per griglie perpendicolari
Corner at 90° for perpendicular gratings
Angle à 90° pour grilles perpendiculaires
Ecke 90° für Rechtwinklige Abdeckroste

Codice griglia Item code Code grille Rostcode	Larghezza Width Largeur Rostbreite	Spessore Thickness Epaisseur Stärke	Colore Colour Couleur Farbe
GAPP-180B	180 mm	25 mm	Bianco (B) White (B) Blanc (B) Weiß (B)
GAPP-200B	200 mm		
GAPP-250B	250 mm		
GAPP-330B	330 mm		

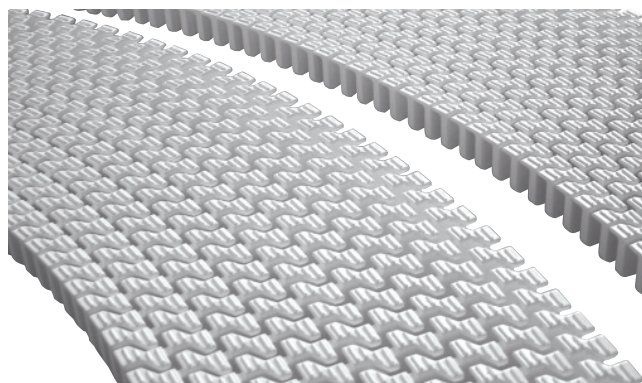

Mod. GPCB

Padana-Grid

Griglia perpendicolare, curvabile in polipropilene con barre ad incastro
Perpendicular bendable grating made of polypropylene with set-in bars
Grille perpendiculaire adaptable en polypropylène avec barreaux encastrés
Rechtwinkliges, biegbares Abdeckrost aus Polypropylen mit einklemmenden Elementen

Codice griglia Item code Code grille Rostcode	Larghezza Width Largeur Rostbreite	Peso ML Weight LM Poids ML Gewicht LM	Spessore Thickness Epaisseur Stärke	Colore Colour Couleur Farbe
GPCB-180B	180 mm	2,3 kg	25 mm	Bianco (B) White (B) Blanc (B) Weiß (B)
GPCB-200B	198 mm	2,4 kg		
GPCB-250B	248 mm	3,2 kg		
GPCB-300B	300 mm	4,0 kg		

Elementi standard 1,00 metro Standard elements 1,00 meter Elements standard 1,00 mètre
Geliefert in Stücke von 1,00 Meter

Altri colori a richiesta Other colours on demand Autres couleurs sur demande Andere Farben auf Anfrage

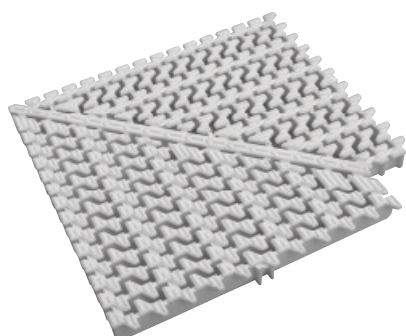

Mod. GACB

Padana-Grid

Angolo a 90° per griglia perpendicolare curvabile
Corner at 90° for perpendicular bendable grating
Angle a 90° pour grille perpendiculaire adaptable
Ecke 90° für rechtwinklige biegbare Abdeckrost

Codice griglia Item code Code grille Rostcode	Larghezza Width Largeur Rostbreite	Spessore Thickness Epaisseur Stärke	Colore Colour Couleur Farbe
GACB-180B	180 mm	25mm	Bianco (B) White (B) Blanc (B) Weiß (B)
GACB-250B	248 mm		

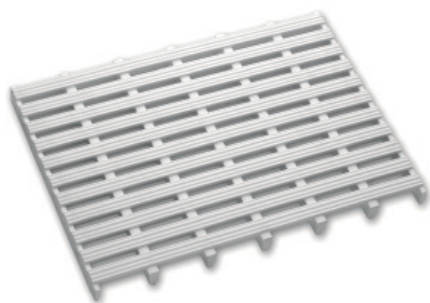

Mod. **GPRP**

Padana-Grid

Griglia parallela rigida stampata

Moulded parallel rigid grating

Grille parallèle rigide moulée

Gepresster paralleler steifer Abdeckrost

Codice griglia Item code Code grille Rostcode	Larghezza Width Largeur Rostbreite	Peso ML Weight LM Poids ML Gewicht LM	Spessore Thickness Epaisseur Stärke	Colore Colour Couleur Farbe
GPRP-182B	181 mm	1,8 kg	25 mm	Bianco (B) White (B) Blanc (B) Weiß (B)
GPRP-250B	245 mm	2,5 kg		
GPRP-330B	330 mm	3,3 kg		

Elementi standard 33,3 cm Standard elements 33,3 cm Elements standard 33,3 cm
Geliefert in Stücke von 33,3 cm

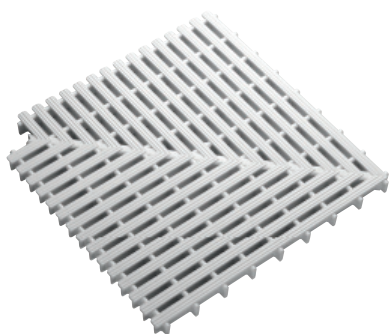

Mod. **GARS**

Padana-Grid

Angolo a 90° per griglia parallela stampata

Corner at 90° for moulded parallel grating

Angle a 90° pour grille parallèle moulée

Ecke 90° für gepresste parallele Abdeckrost

Codice griglia Item code Code grille Rostcode	Larghezza Width Largeur Rostbreite	Spessore Thickness Epaisseur Stärke	Colore Colour Couleur Farbe
GARS-182B	181 mm	25 mm	Bianco (B) White (B) Blanc (B) Weiß (B)
GARS-250B	245 mm		
GARS-330B	330 mm		



Mod. **GPAP**

Padana-Grid

Griglia parallela rigida assemblata

Assembled parallel rigid linear grating

Grille parallèle, rigide assemblée

Paralleles, zusammengefügt Abdeckrost

Codice griglia Item code Code grille Rostcode	Larghezza Width Largeur Rostbreite	Peso Weight Poids Gewicht	Spessore Thickness Epaisseur Stärke	Colore Colour Couleur Farbe
GPAP-150B	150 mm	2,5 kg	25 mm	Bianco (B) White (B) Blanc (B) Weiß (B)
GPAP-180B	180 mm	3,0 kg		
GPAP-200B	200 mm	3,3 kg		
GPAP-250B	250 mm	4,1 kg		
GPAP-330B	330 mm	5,4 kg		

Larghezza minima 150 mm. Elementi standard 1,00 metro Minimum width 150 mm. Standard elements 1,00 meter Largeur minimale 150 mm. Elements standard 1,00 mètre Minimale Breite 150 mm. Geliefert in Stücke von 1,00 Meter

Altri colori a richiesta Other colours on demand Autres couleurs sur demande Andere Farben auf Anfrage

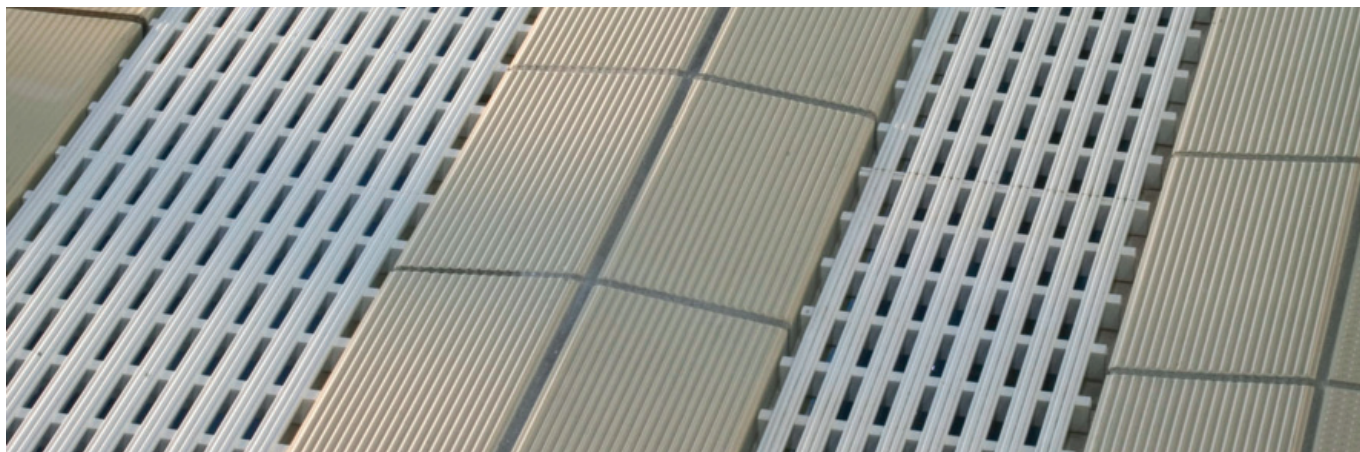

SUPPORTI GRIGLIA GRATING SUPPORTS SUPPORTS DE GRILLE ROSTTRÄGER

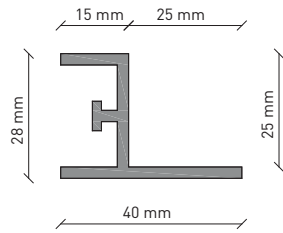
**SL25 PVCB***

Padana-Grid

Codice articolo Item code Code piece Artikel	Materiale Material Matériel Material	Colore Colour Couleur Farbe	Lunghezza Length Longueur Länge	Pezzi per fascio Pcs per bundle Piece par faisceau Stücke je Bündel	Peso ML Weight LM Poids ML Gewicht LM
SL25 PVCB	PVC	Bianco (B) White (B) Blanc (B) Weiß (B)	2,5 m	20 pcs	0,35 kg

* Conservare al riparo dalla luce solare ed a temperature <40°C Keep away from sunlight and store at temperatures <40°C
 Conserver à l'abri du rayonnement solaire et à des températures <40 °C Vor Sonnenlicht geschützt und bei Temperaturen <40°C lagern

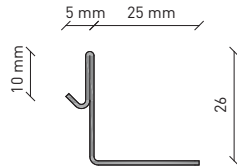
**SL25 IR16**

Padana-Grid

Codice articolo Item code Code piece Artikel	Materiale Material Matériel Material	Colore Colour Couleur Farbe	Lunghezza Length Longueur Länge	Pezzi per fascio Pcs per bundle Piece par faisceau Stücke je Bündel	Peso ML Weight LM Poids ML Gewicht LM
SL25 IR16	Acciaio inox * Stainless Steel * Acier inox * Edelstahl *	Lucido Polished Poli Glanzend	1,48 m	1 pc	1,0 kg

* AISI 316L – BA EN 1.4404

Classe di corrosività C4 Corrosion Class C4 Catégorie de corrosivité C4 Korrosionsklasse C4

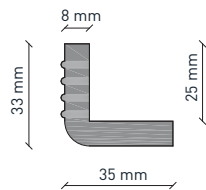
**0500 100S**

Padana-Grid

Codice articolo Item code Code piece Artikel	Materiale Material Matériel Material	Colore Colour Couleur Farbe	Lunghezza Length Longueur Länge	Pezzi per scatola Pcs per bundle Piece par faisceau Stücke je Bündel	Peso pezzo Weight PC Poids PC Gewicht PC
0500 100S	Ceramica Ceramic Céramique Keramik	Bianco 100 Tundra (smaltato) White 100 Tundra (glazed) Blanc 100 Tundra (émaillé) Weiß 100 Tundra (glasierte)	0,243 m	36 pcs	0,25 kg

ANCORAGGI IN ACCIAIO INOX PER CORSIE GALLEGGIANTI STAINLESS STEEL ANCHORS FOR FLOATING LANES
ANCRAGES EN ACIER INOX POUR COULOIRS FLOTTANTS VERANKERUNGEN AUS ROSTFREIEM STAHL FÜR SCHWIMMBAHNLEINEN

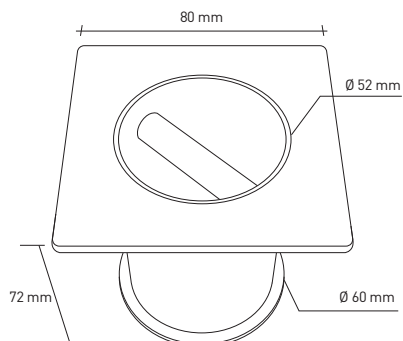

AANC 041A

Padana-Grid

Ancoraggio da parete (per cemento armato) realizzato in acciaio inossidabile AISI-316 da incassare sulle testate della vasca per il posizionamento delle corsie galleggianti.

Wall anchorage (for concrete) made of stainless steel AISI-316 to be set on headwalls of pool to fix floating lanes.

Ancrage de paroi (pour béton) en acier inoxydable AISI-316 à positionner sur le quai de départ pour fixer les couloirs flottants.

Wandverankerung (für Beton) aus rostfreiem Edelstahl AISI-316 zum einbetten in die Stirnwände für die Schwimmbahnleinen.

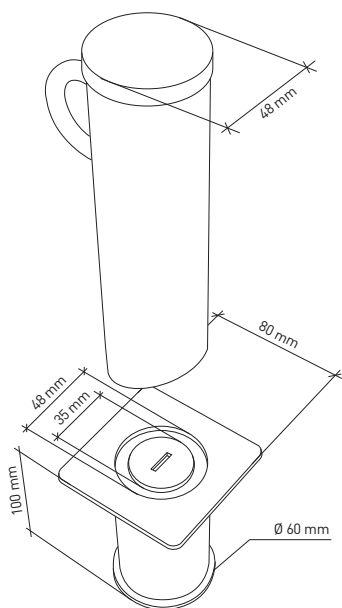

APAL 055A

Padana-Grid



AANC 051A

Padana-Grid

Ancoraggio da pavimento (per cemento armato) e paletto estraibile (art. APAL-055A) realizzati in acciaio inossidabile AISI-316 da incassare sul bordo vasca per il posizionamento delle corsie galleggianti.

La base di questo ancoraggio serve anche per fissare placche di virata, indicatori di virata e falsa partenza e scalette amovibili.

Pool deck anchor (for concrete) and removable post (Item APAL-055A) made of stainless steel AISI-316 to be set on pool deck to fix floating lanes. The same anchorage can be used to fix turning panels, false start and backstroke warning indicators as well as removable ladders.

Ancrage au sol (pour béton) et piquet amovible (Art. APAL-055A) en acier inoxydable AISI-316 à positionner sur la tête de bassin pour fixer les couloirs flottants. Le même ancrage peut être utilisé pour fixer les plaques de retour, les lignes de virage et faux départ et les échelles amovibles.

Bodenverankerung (für Beton) und ausziehbare Riegel (Art. APAL-055A) aus rostfreiem Edelstahl AISI-316 zum einbetten in dem Beckenumgang für die Schwimmbahnleinen. Die gleiche Verankerung kann man für Befestigung von Wendepfatten, Rückenwende und Fehlstartleinen sowie Beckensteigleitern verwenden.

**BOCCHETTE DI SCARICO PER CANALETTA DI VASCA WATER OUTLETS FOR SCUM CHANNEL
EVACUATIONS EAUX DE BASSIN WASSERABLAUF FÜR ÜBERFLUTUNGSRINNE**

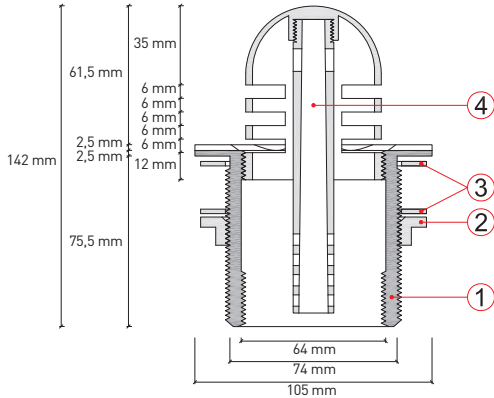

- 1 Base bocchetta Base of water outlet Base du siphon Basis Wasserablauf
- 2 Ghiera di bloccaggio Tightening screw Vis de serrage Spannschraube
- 3 Guarnizioni in plastica Plastic gaskets Joints en plastique Kunststoffdichtungen
- 4 Griglia di pre-filtraggio silenziosa Silent pre-filtering grating Grille de pre-filtrage silencieuse Geräuscharmes Vorfiltergitter

Bocchetta in materiale plastico ABS da 2,5" con scarico diametro 64 mm (capacità 120 litri/minuto), griglia di pre-filtraggio e sistema antigorgoglio.

Siphon en matériel plastique ABS de 2,5" avec évacuation de 64 mm de diamètre (débit 120 litres/minute) , grille de pre-filtrage et système anti-bruit.



ASSV ABSG

Padana-Grid

ABS Plastic water outlets of 2,5" with drain pipe of 64 mm diameter (capacity 120 litres/minute), pre-filtering grid and anti-noise system.

Wasserabläufe aus Kuhnstoff ABS von 2,5" mit Ablauf von 64 mm (120 Liter/Minute), Vorfilter und Belüfter.

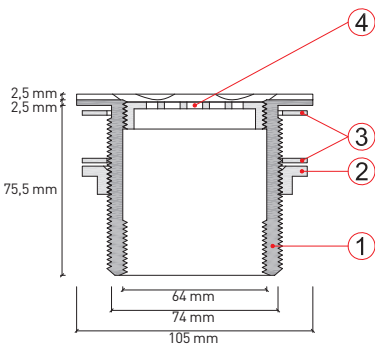

- 1 Base bocchetta Base of water outlet Base du siphon Basis Wasserablauf
- 2 Ghiera di bloccaggio Tightening screw Vis de serrage Spannschraube
- 3 Guarnizioni in plastica Plastic gaskets Joints en plastique Kunststoffdichtungen
- 4 Griglia di pre-filtraggio Pre-filtering grating Grille de pre-filtrage Vorfiltergitter

Bocchetta in materiale plastico ABS da 2,5" di colore grigio (RAL 7040) con griglia di pre-filtraggio e con scarico di diametro 64 mm (capacità 70 litri/minuto).

Siphon de 2,5" en matériel plastique ABS, couleur gris (RAL 7040) avec évacuation de 64 mm diamètre (débit 70 litres/minute) et grille de pre-filtrage.



AS22 ABSG

Padana-Grid

ABS plastic water outlet of 2,5" grey color (RAL 7040) with pre-filtering grating and drain pipe of 64 mm diameter (capacity 70 liters/minute).

Wasserablauf von 2,5" aus Kunststoff ABS , Farbe grau RAL 7040 mit Ablauf von 64 mm Durchmesser (70 Liter/Minute) und Vorfilter.

Padana Deck_Sport&Fun canalette per esterni vasca

CHANNELS FOR POOL DECKS
CANIVEAUX DE PLAGE
BECKENUMGANGSRINNEN

Le canalette sono necessarie in tutti gli ambienti piscina e servono a raccogliere l'acqua nelle aree intorno alle vasche; sia quella dispersa dall'attività natatoria degli utenti che quella necessaria al lavaggio dei pavimenti.

Un insieme di pezzi speciali e sistemi dedicati a questo tipo di finiture permette di recuperare l'acqua sia con sistemi puntuali sia creando canalizzazioni complete con e senza griglie di copertura.

The use of channels is necessary in all pools to collect water on pool deck; both the water scattered by the swimming activities and the one needed to wash the floors.

A line of fittings and systems designed specifically for this type of finish can be used to recover water through a system of channels with or without covering grating.

Le recours à des systèmes de caniveaux s'impose dans toutes les piscines pour récupérer l'eau que les baigneurs amènent sur les plages mais aussi les eaux de lavage des sols.

Une ligne de pièces spéciales et systèmes spécialement conçues pour ce type de finitions permet de récupérer l'eau moyennant un système de caniveaux sans ou avec grille de recouvrement.

Die Rinnen sind in allen Schwimmbadbereichen erforderlich und dienen der Sammlung des Wassers in den umgebenden Beckenumgängen; dabei wird sowohl das beim Schwimmen von den Badegästen verspritzte Wasser als auch das zur Fußbodenreinigung verwendete Wasser aufgesammelt.

Ein dieser Art der Endbearbeitungen gewidmeter Formteilsatz ermöglicht die Rückgewinnung des Wassers, sowohl mittels punktueller Systeme als auch anhand der Verlegung kompletter Kanalisierungen mit und ohne Abdeckroste.



Mod.CP 001

CANALETTA PIANA E SCARICO A QUATTRO PENDENZE ANTISCIVOLO NON-SLIP FLAT CHANNEL AND INDEPENDENT WATER OUTLET
CANIVEAU PLAT ET CUNETTE DE'ECOLEMENT ANTIDERAPANTS NON-SLIP FLACHRINNE UND FREIES WASSERABLAUF

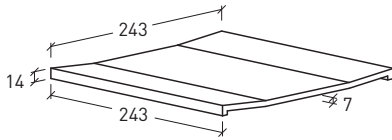

4500

Padana-Deck 8 pc/box 1,10 kg/pc 4 pc/ml

ELEMENTI - Grip*



010 Talco



011 Avorio



060 Cemento

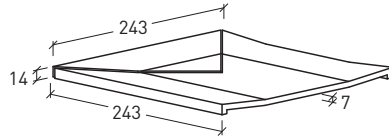

4503

Padana-Deck 8+8 pc/box 01,10 kg/pc

ELEMENTI - Grip*



010 Talco



011 Avorio



060 Cemento

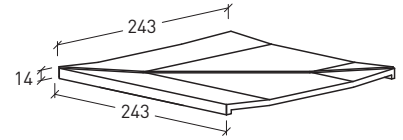

4508

Padana-Deck 2 pc 45° 8+8 pc/box 1,10 kg/pc

ELEMENTI - Grip*



010 Talco



011 Avorio



060 Cemento

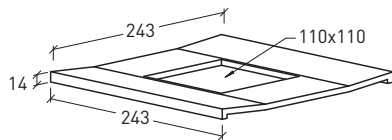

4509

Padana-Deck 8 pc/box 1,00 kg/pc

ELEMENTI - Grip*



010 Talco



011 Avorio



060 Cemento

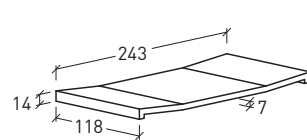

4520

Padana-Deck 16 pc/box 0,60 kg/pc 8 pc/ml

ELEMENTI - Grip*



010 Talco



011 Avorio



060 Cemento

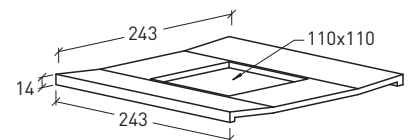

4609

Padana-Deck 8 pc/box 1,00 kg/pc

ELEMENTI - Grip*



010 Talco



011 Avorio



060 Cemento

* Colori 020 Onda, 021 Mare e 070 Ebano solo su richiesta
Colours 020 Onda, 021 Mare and 070 Ebano on request only
Coloris 020 Onda, 021 Mare et 070 Ebano uniquement sur demande
Farben 020 Onda, 021 Mare und 070 Ebano nur Auf Anfrage

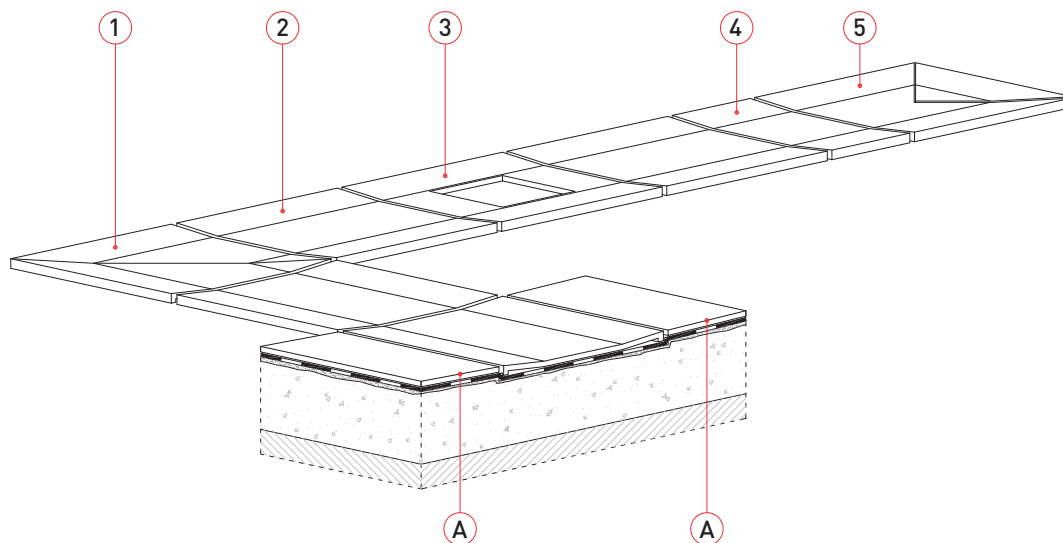

A piastrella spiaggia pool deck tile carreau de plage beckenumgang-fliese

Per le bocchette di scarico da applicare a questo sistema vedi pag. 75
For the water outlets suitable to this system see pages 75
Pour les siphons de ce système voir pages 75
Für die Wasserabläufe dieses Systems siehe Seiten 75

Mod.CP 002

CANALETTE CON GRIGLIE DI COPERTURA CHANNELS WITH GRATINGS CANIVEAUX AVEC GRILLES RINNEN MIT ABDECKROSTE

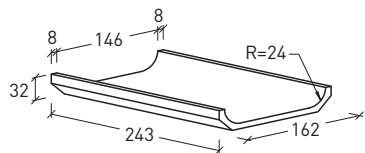

4700

Padana-Deck 10 pc/box 0,80 kg/pc 4 pc/ml

LANDSCAPE - Satin



100 Tundra

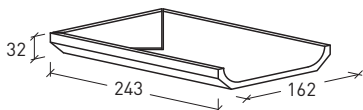

4703

Padana-Deck 5+5 pc/box 0,80 kg/pc

LANDSCAPE - Satin



100 Tundra

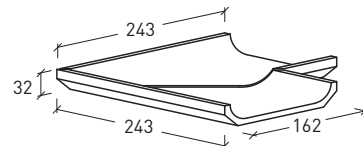

4708

Padana-Deck 2 pc 45° 5+5 pc/box 1,00 kg/pc

LANDSCAPE - Satin



100 Tundra

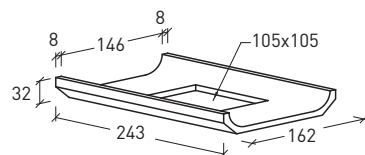

4709

Padana-Deck 10 pc/box 0,70 kg/pc

LANDSCAPE - Satin



100 Tundra

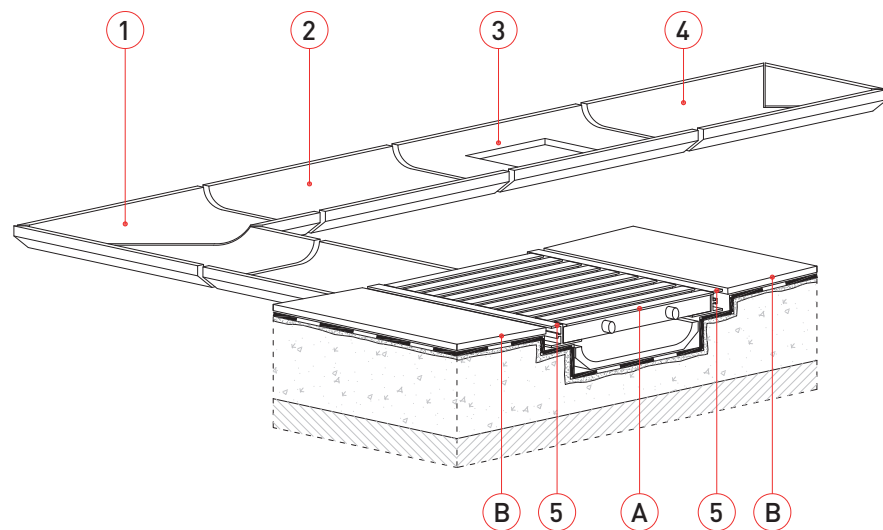

A griglia in pvc grating in pvc grille en pvc pvc rost

B piastrella spiaggia pool deck tile carreau de plage beckenumgang-fliese

Per le bocchette di scarico da applicare a questo sistema vedi pag. 75
 For the water outlets suitable to this system see pages 75
 Pour les siphons de ce système voir pages 75
 Für die Wasserabläufe dieses Systems siehe Seiten 75

Mod.CP 003

CANALETTE CON GRIGLIE DI COPERTURA CHANNELS WITH GRATINGS CANIVEAUX AVEC GRILLES RINNEN MIT ABDECKROSTE

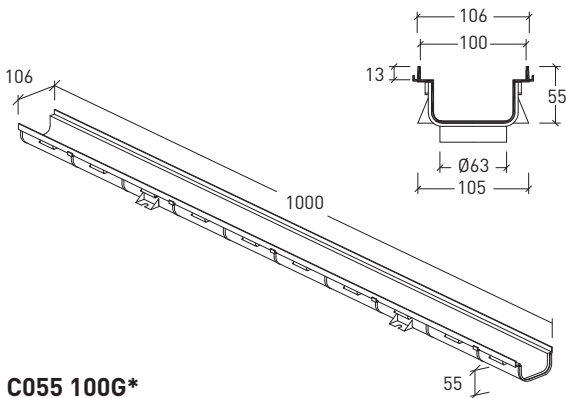

C055 100G*

Padana-Grid 12 pc/box 0,9 kg/pc

Canaletta in PVC con scarico verticale Ø 40 mm o Ø 63 mm **
PVC channel with vertical outlet Ø 40 mm or Ø 63 mm
Caniveau en PVC avec évacuation verticale Ø 40 mm ou Ø 63 mm
PVC Rinne mit vertikalem Wasserablauf Ø 40 mm oder Ø 63 mm

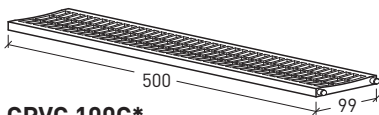

GPVC 100G*

Padana-Grid 1 pc/box 0,4 kg/pc

Griglia in Pvc / Pvc grating / Grille en Pvc / Rost aus Pvc

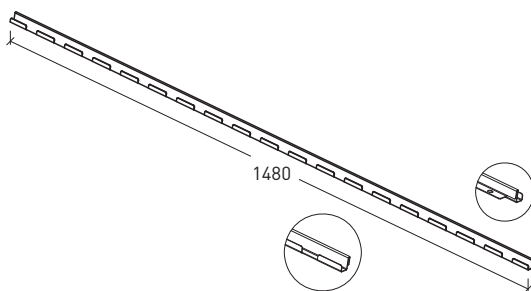

GK03 4A15***

Padana-Grid 1 pc/box 0,55 kg/pc

Profilo laterale inox per canaletta Pvc
Stainless steel lateral profile for Pvc channel
Profil latéral inox pour caniveau en Pvc
Seitenprofile aus Edelstahl für Rinne aus Pvc

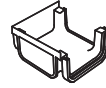

A055 100G*

Padana-Grid 10 pc/box 0,12 kg/pc

Angolo/incrocio a 3 o 4 vie in PVC con scarico verticale Ø 40 mm o Ø 80 mm **
PVC corner/ T or X junction with vertical outlet Ø 40 mm o Ø 80 mm
Angle/jonction en T ou en X en PVC avec évacuation verticale Ø 40 mm o Ø 80 mm
PVC Ecke T oder X förmige Kreuzung Ø 40 mm o Ø 80 mm



T055 100G*

Padana-Grid 25 pc/box 0,05 kg/pc

Testata in PVC con scarico orizzontale Ø 50 mm **
PVC stop-end with horizontal outlet Ø 50 mm
About en PVC avec évacuation horizontale Ø 50 mm
Endstück aus PVC mit horizontalem Wasserablauf Ø 50 mm

* Conservare al riparo dalla luce solare ed a temperature < 40°C
Keep away from sunlight and store at temperatures <40°C
Conserver à l'abri du rayonnement solaire et à des températures <40 °C
Vor Sonnenlicht geschützt und bei Temperaturen <40°C lagern

** Scarico da forare in cantiere (solo se necessario)
outlet to be drilled on the job site (only when necessary)
Évacuation à percer en chantier (uniquement si nécessaire)
Wasserablauf auf der Baustelle zu schneiden (erforderlichenfalls)

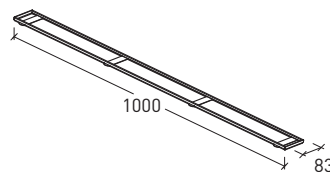

GK03 4B10***

Padana-Grid 1 pc/box 1,4 kg/pc

Vaschetta portapiastrelle inox
Stainless steel tray for ceramic tiles
Bac inox pour carreaux
Fliesenträger aus Edelstahl

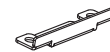

GK03-4CPP ***

Padana-Grid 1 pc/box 1,4 kg/pc

Testata per vaschetta inox
Step end for stainless steel tray
About pour bac inox
Endstück für Fliesenträger aus Edelstahl

*** Articoli realizzati con acciaio inox AISI 316L-BA - EN 1.4404 (Lucido) / Classe di corrosività C4
Items made with stainless steel AISI 316L-BA - EN 1.4404 (Polished) / Corrosion Class C4
Références fabriquées en acier inox AISI 316L-BA - EN 1.4404 (Poli) / Catégorie de corrosivité C4
Artikel aus Edelstahl AISI 316L-BA - EN 1.4404 (Glanzend) / Korrosionsklasse C4

Mod.CP003-GK03 - Modulo 100

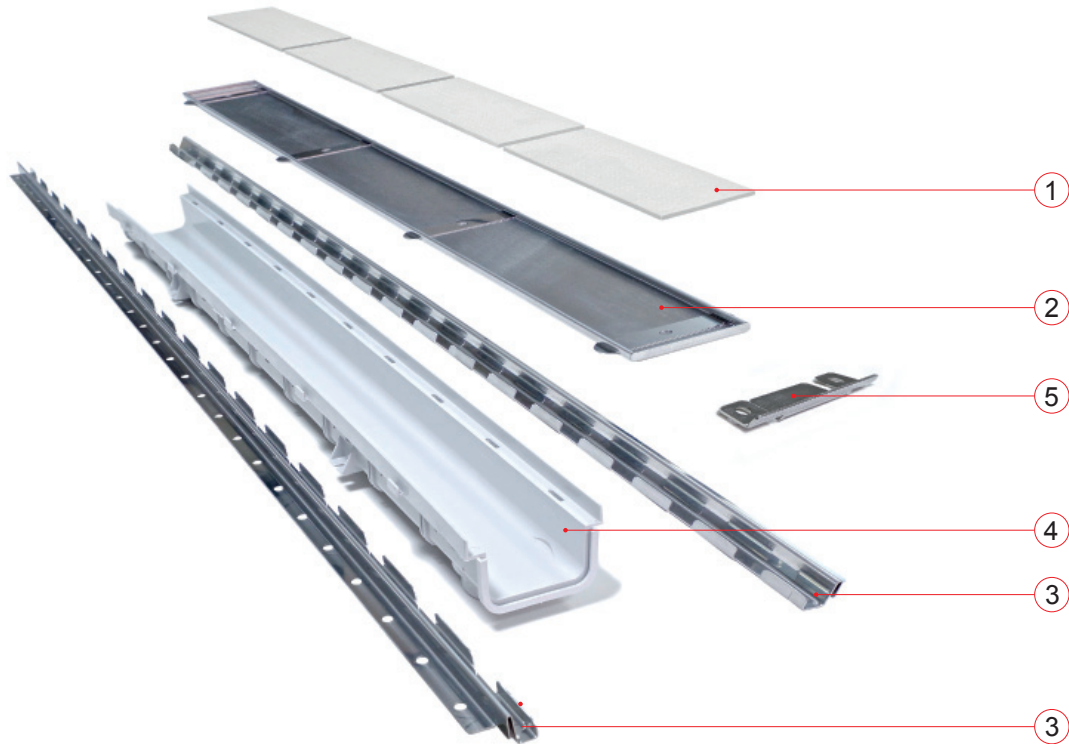

Griglia ceramica amovibile / Removable ceramic grating / Grille céramique amovible / Abnehmbare keramische Roste

1 Piastrelle da tagliare in cantiere Tiles to be cut on job site Carreaux à découper en chantier Fliesen auf die Baustelle zu schneiden

2 GK03 4B10







3 GK03 4A15

4 C055 100G







5 GK03 4CPP



ELEMENTI - Matt

		
010 Talco	011 Avorio	021 Mare
		
060 Cemento	061 Basalto	070 Ebano

ELEMENTI - Pinhead

		
010 Talco	011 Avorio	021 Mare
		
060 Cemento	061 Basalto	070 Ebano

ELEMENTI - Roccia

	
010 Talco	011 Avorio

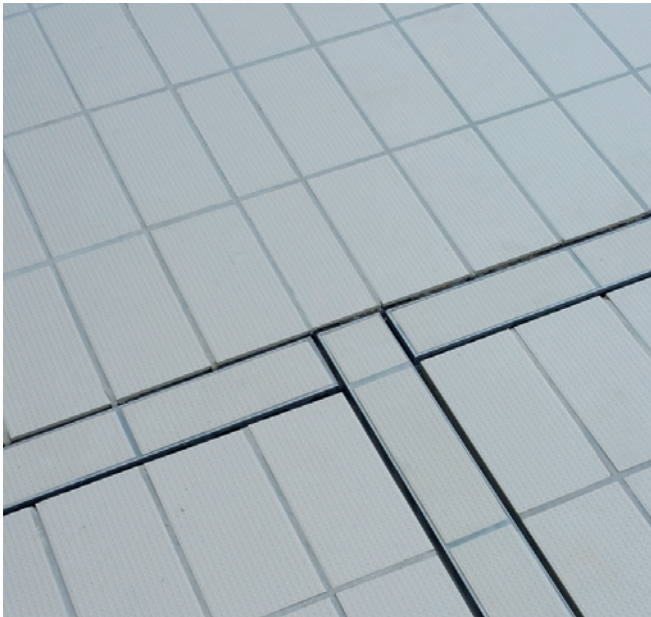

Mod. CP003-GK03 - Modulo 100

Mod.CP003-PVC

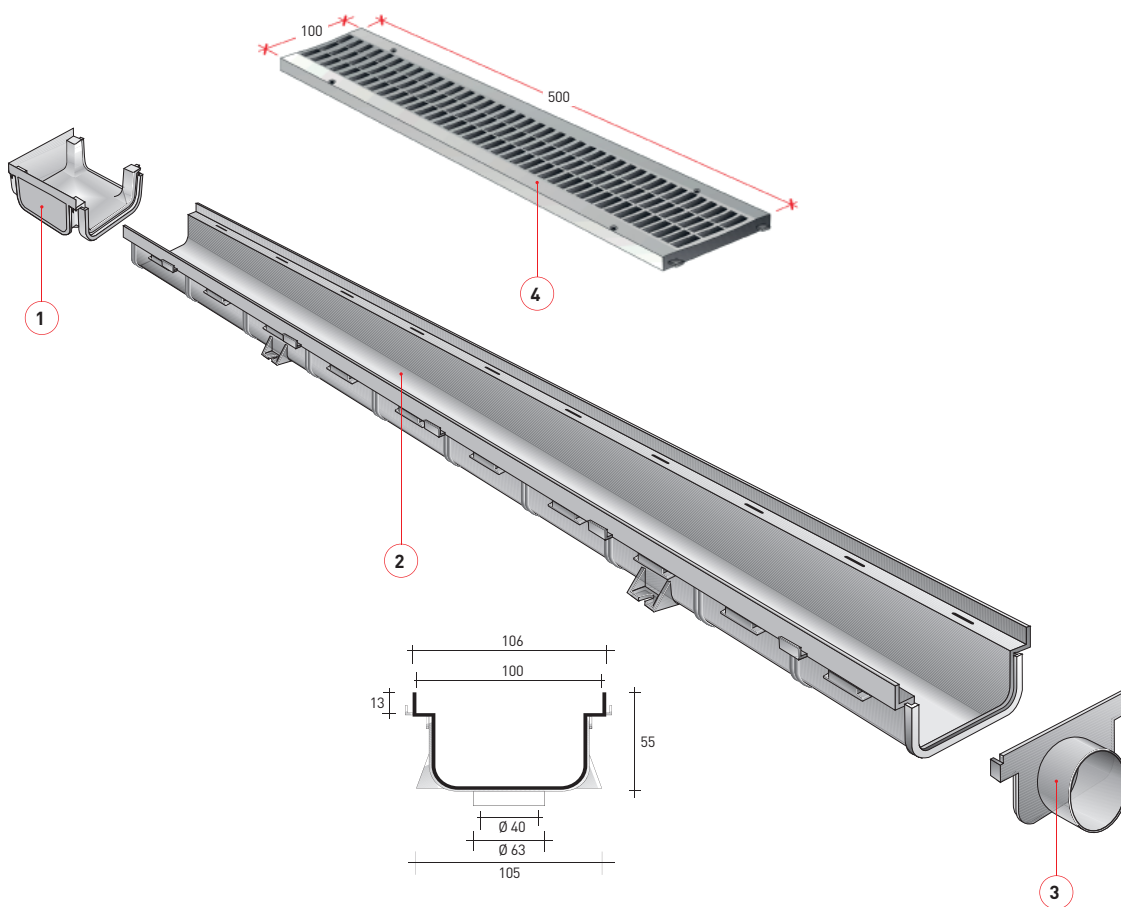

- 1 A055 100G
- 2 C055 100G
- 3 T055 00G
- 4 GPVC 100G

**BOCCHETTE DI SCARICO PER CANALETTE DI ESTERNO VASCA WATER OUTLETS FOR DECK CHANNELS EVACUATIONS CANIVEAUX DE PLAGE
WASSERÄBLAUF FÜR BECKENUMGÄNGSRINNEN**

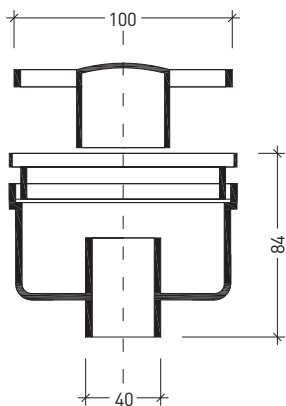

AS12 040G

Padana-Deck

Bocchetta in ABS grigio 100x100 mm con scarico verticale diametro 40 mm

Water outlet in ABS grey colour 100x100 mm with vertical drain pipe 40 mm diameter.

Siphon en ABS gris 100x100 mm avec évacuation verticale 40 mm diamètre.

Wasserablauf 100x100 mm aus grauem ABS mit vertikalem Ablauf 40 mm Durchmesser.

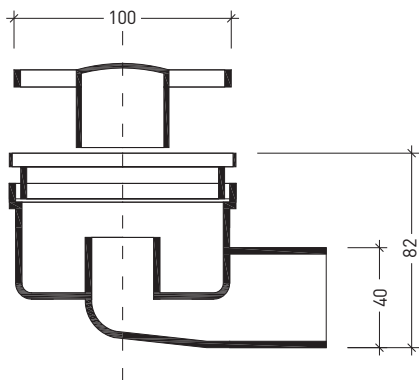

AS13 040G

Padana-Deck

Bocchetta in ABS grigio 100x100 mm con scarico orizzontale diametro 40 mm

Water outlet in ABS grey colour 100x100 mm with horizontal drain pipe 40 mm diameter.

Siphon en ABS gris 100x100 mm avec évacuation horizontale 40 mm diamètre.

Wasserablauf 100x100 mm aus grauem ABS mit horizontalem blauf 40 mm Durchmesser.

**BOCCHETTE DI SCARICO IMPERMEABILIZZATE PER CANALLETTE DI ESTERNO VASCA WATERPROOFING WATER OUTLETS FOR DECK CHANNELS
EVACUATIONS ETANCHES POUR CANIVEAUX DE PLAGE ABGEDICHTETE WASSERABLÄUFE FÜR BECKENUMGANGSRINNEN**

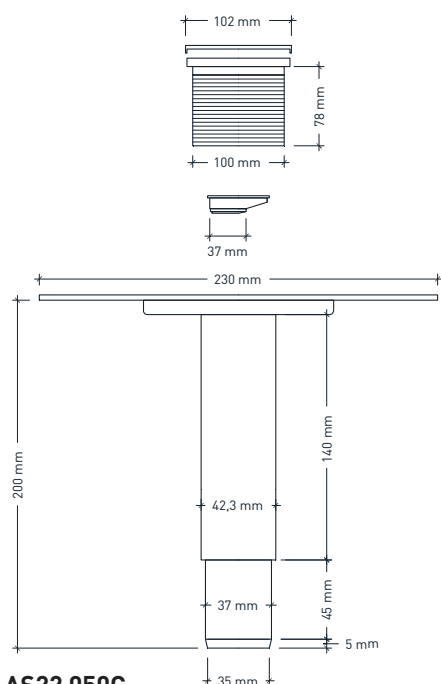
**AS22 050G**

Padana-Deck

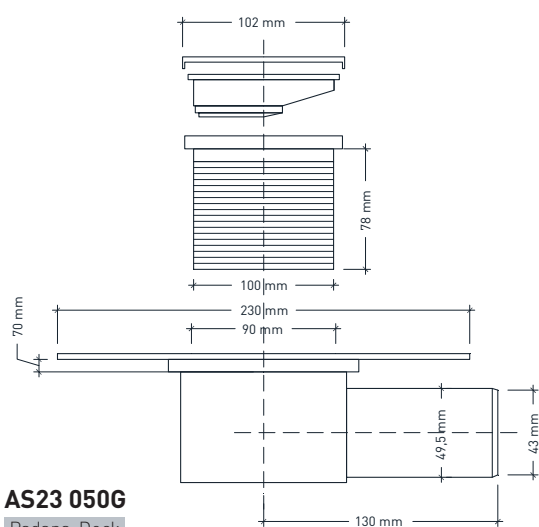
**AS23 050G**

Padana-Deck



Le bocchette di scarico AS22 050G (scarico verticale) e AS23 050G (scarico orizzontale) sono capaci di assicurare la continuità con l'impermeabilizzazione del pavimento circostante grazie al processo di termo fusione che unisce il telo impermeabile con la flangia della bocchetta. Entrambi i modelli sono dotati di scarico con diametro di 35 mm, della prolunga intagliabile per la gestione degli spessori, del tappo antiodore e della elegante griglia in acciaio inox AISI 304 100x100 mm.

The water outlets AS22 050G (vertical) and AS23 050G (horizontal) are able to ensure continuity of waterproofing on pool decks thanks to the waterproofing membrane duly connected with lower part of the outlets. Both models have are equipped with 35 mm drain pipe, with an adjustable extension to manage different thicknesses of concrete, with anti-odour -cap and with an elegant stainless steel grid AISI 304 100x100 mm.

Les siphons AS22 050G (vertical) et AS23 050G (horizontal), garantissent la continuité de l'étanchéité de la plage grâce à la membrane soudé à la partie inférieure des siphons. Les deux modèles sont équipés d'une sortie de 35 mm, d'un rallonge à couper par rapport à l'épaisseur de la chape, d'un coupe-odeurs et d'une élégante grille en acier inox AISI 304 100x100 mm.

Die Wasserabläufe AS22 050G (vertikal) und AS23 050G (horizontal) gewährleisten die Kontinuität mit der Abdichtung des umliegenden Bodens und dies der wasserdichten Membran dankend. Beide Typen sind ausgestattet mit Düse zu 35 mm Durchmesser, einstellbarer Verlängerung um unterschiedlichen Höhen zu regeln, Geruchskappe und eleganter Gitter aus Edelstahl AISI 304 100x100 mm.

Bordi vasca

POOL BORDERS
TETES DE BASSIN
BECKENKÖPFE

La piscina è una costruzione ad elevato contenuto tecnico prestazionale che richiede un approccio progettuale ed una esecuzione cantieristica estremamente accurata: dai sistemi per il recupero acqua al rivestimento in sicurezza degli elementi architettonici.

Quelle che seguono sono alcune proposte dei principali sistemi di bordo vasca completi di pezzi speciali ed accessori ma l'ufficio tecnico della divisione Swimming Pool di Casalgrande Padana è disponibile a sviluppare soluzioni diverse e personalizzate.

Pools are highly technical and performance structures that require extremely accurate design planning and site execution to achieve a perfect final result.

Following is a summary range of different types of pool borders equipped with fittings and accessories, although Casalgrande Padana's Swimming Pool division is available to develop alternative and customized solutions.

La piscine est avant tout une construction très technique qui exige une programmation et une prescription précises afin de pouvoir réaliser un ouvrage parfait : des systèmes de récupération de l'eau aux revêtements sécurisés des éléments architecturaux.

Les suivants ne sont que des exemples des divers types de têtes de bassin équipées de pièces spéciales et accessoires, bien que la division technique Swimming Pool de Casalgrande Padana soit disponible à développer des solutions alternatives et personnalisées.

Ein Schwimmbad ist eine Konstruktion mit einem hohen technischen Gehalt, die einen planerischen Ansatz und eine extrem akkurate Baustellenausführung erforderlich macht: von den Wasseraufbereitungsanlagen bis hin zur sicheren Verkleidung der architektonischen Elemente.

Infolge einige Vorschläge zu den wesentlichen Beckenrandsystemen mit Formteilen und Zubehör. Das Ingenieurbüro der Abteilung Swimming Pool von Casalgrande Padana steht jedoch zur Entwicklung unterschiedlicher und individueller Lösungen zur Verfügung.



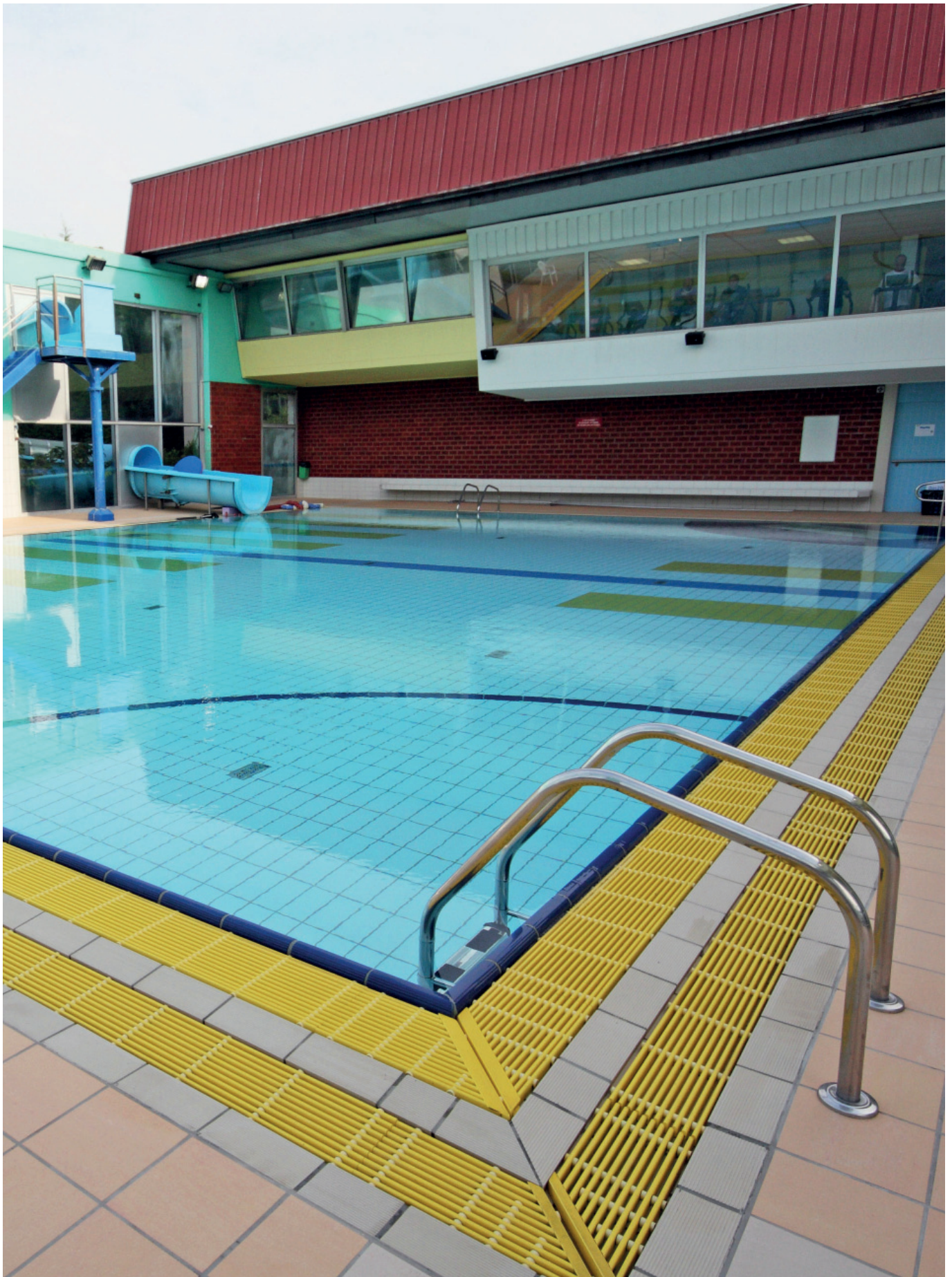

Sistema finlandese

FINNISH SYSTEM
SYSTEME FINLANDAIS
SYSTEM FINNLAND

Il bordo vasca Finlandese è un sistema a sfioro superficiale con prelievo continuo e canaletta di recupero dell'acqua per il ricircolo.

Questo bordo vasca può essere realizzato con pezzi speciali "tradizionali" che comportano una preparazione del sottofondo cementizio adeguatamente sagomato. In questo caso il minor costo dei pezzi utilizzati deve però tener conto di maggiori oneri per la preparazione del supporto in cemento, della impermeabilizzazione e della posa.

Più semplice e rapida è invece la soluzione con gli esclusivi pezzi speciali Trim-Box dove tutti i pezzi del sistema hanno lo stesso spessore e una perfetta modularità. Questo permette di realizzare sagome in c.a. più semplici e facilita la posa dei pezzi speciali.

The Finnish pool border is an overflow system with continuous water collection and a channel to bring water to the re-circulation system.

This type of pool border may be designed with traditional fittings that imply a suitably shaped concrete screed to be installed. The lower cost of the fittings is however, generally offset by additional costs for preparing, concrete, waterproofing and for installation of fittings.

Conversely, the exclusive Trim-Box fittings account for a much easier and quick solution, as they all feature the same thickness and are perfectly modular. As such they allow simpler concrete structures and make easier the installation of fittings.

La tête de bassin finlandaise est un système à débordement par surverse et goulotte de récupération de l'eau pour son recyclage.

Ce type de tête de bassin est réalisé par des pièces spéciales « traditionnelles » qui entraînent la préparation du béton correctement modelé.

Le cout inférieur des pièces utilisées est toutefois compensé par des frais supplémentaires de préparation du béton, d'exécution de l'étanchéité et de la pose.

D'ailleurs, les pièces spéciales Trim-Box à épaisseur égale offrent une solution plus simple et rapide grâce à leur parfaite modularité, ce qui permet de simplifier la réalisation des supports en béton et la pose de ces pièces.

Die Finnische Rinne ist ein Überlaufsystem mit Schwallwasserkanal für die Wasseraufbereitung.

Dieser Beckenrand kann mit "traditionellen" Formteilen verlegt werden, die eine Vorbereitung des Zementuntergrundes mittels angemessener Formung erforderlich machen.

In diesem Fall müssen jedoch obgleich der geringeren Kosten der verwendeten Teile der Mehraufwand bei der Vorbereitung des Zementträgers, bei der Abdichtung sowie beim Verlegen berücksichtigt werden.

Einfacher und schneller ist hingegen eine Verwendung der exklusiven Formteile Trim-Box. Alle Teile dieses Systems haben die gleiche Stärke sowie eine perfekte Modularbauweise. Das gestattet die Konstruktion von einfacheren Profilen aus Stahlbeton und vereinfacht das Verlegen der Formteile.

sistema finlandese / finnish system / système finlandais / system finland



BORDO FINLANDESE TRADIZIONALE SENZA AGGRAPPO – SUPERFICIE PINHEAD FINNISH POOL BORDER WITHOUT FINGER GRIP – SURFACE PINHEAD
TÊTE FINLANDAISE TRADITIONNELLE SANS ACCROCHE DOIGTS – FINITION PINHEAD BECKENKOPFEN FINNLAND OHNE HANDFASS – OBERFLÄCHE PINHEAD

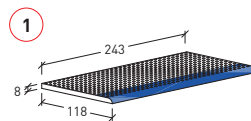
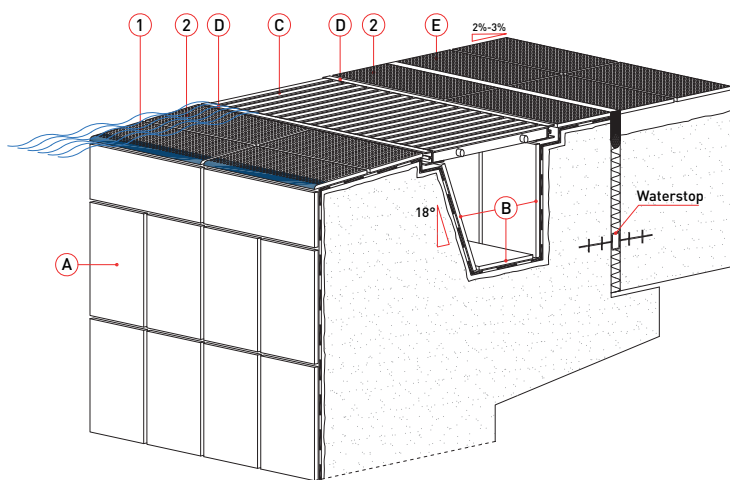

3356 Banda blu

ELEMENTI - Pinhead



010 Talco 011 Avorio

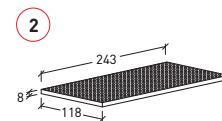

1100

ELEMENTI - Pinhead

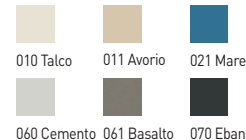

010 Talco 011 Avorio 021 Mare
060 Cemento 061 Basalto 070 Ebano

mod. FEP 1100.0

- A LANDSCAPE - Satin_interno vasca / pool tank / interieur bassin / becken
- B LANDSCAPE - Satin_canaletta di ricircolo / overflow channel / caniveau eau bassin / rinne
- C PADANA GRID_griglia in pvc / grating in pvc / grille en pvc / pvc rost
- D PADANA GRID_angolare in pvc / pvc grating support / corniere en pvc / pvc rost traeger
- E ELEMENTI - Pinhead_esterno vasca / pool surround / plage / beckenumgang

BORDO FINLANDESE TRADIZIONALE CON AGGRAPPO – SUPERFICIE PINHEAD FINNISH POOL BORDER WITH FINGER GRIP – SURFACE PINHEAD
TÊTE FINLANDAISE TRADITIONNELLE AVEC ACCROCHE DOIGTS – FINITION PINHEAD BECKENKOPF FINNLAND MIT HANDFASS – OBERFLÄCHE PINHEAD

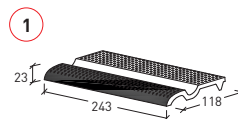
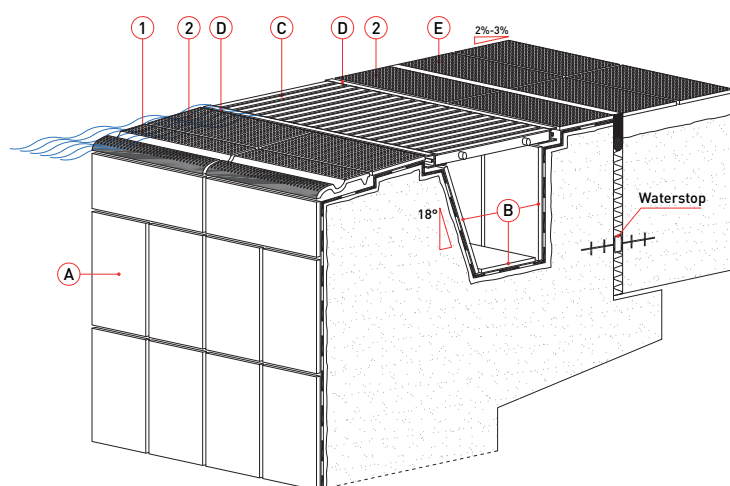

7300 Banda Nera

ELEMENTI - Pinhead



010 Talco 060 Cemento

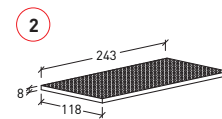

1100

ELEMENTI - Pinhead



010 Talco 011 Avorio 021 Mare
060 Cemento 061 Basalto 070 Ebano

mod. FCP 1101.0

- A LANDSCAPE - Satin_interno vasca / pool tank / interieur bassin / becken
- B LANDSCAPE - Satin_canaletta di ricircolo / overflow channel / caniveau eau bassin / rinne
- C PADANA GRID_griglia in pvc / grating in pvc / grille en pvc / pvc rost
- D PADANA GRID_angolare in pvc / pvc grating support / corniere en pvc / pvc rost traeger
- E ELEMENTI - Pinhead_esterno vasca / pool surround / plage / beckenumgang

BORDO FINLANDESE TRADIZIONALE CON AGGRAPPO – SUPERFICIE RIGATA FINNISH POOL BORDER WITH FINGER GRIP – SURFACE RIGATA / TÊTE FINLANDAISE TRADITIONNELLE AVEC ACCROCHE DOIGTS – FINITION RIGATA BECKENKOPF FINNLAND MIT HANDFASS – OBERFLÄCHE RIGATA

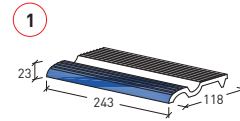
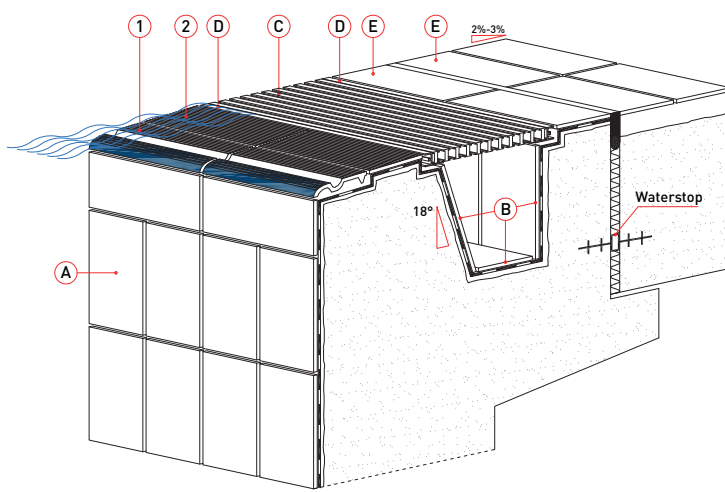

7200 Banda Blu

LANDSCAPE - Rigata

100 Tundra

ELEMENTI - Rigata

010 Talco

011 Avorio

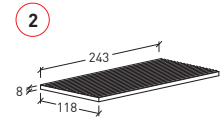

3200

LANDSCAPE - Rigata

100 Tundra

200 Bay

202 Ocean

ELEMENTI - Rigata

010 Talco

011 Avorio

021 Mare

mod. FCC 1101.0

- A LANDSCAPE - Satin_interno vasca / pool tank / interieur bassin / becken
- B LANDSCAPE - Satin_canaletta di ricircolo / overflow channel / caniveau eau bassin / rinne
- C PADANA GRID_griglia in pvc / grating in pvc / grille en pvc / pvc rost
- D PADANA GRID_angolare in pvc / pvc grating support / corniere en pvc / pvc rost traeger
- E ELEMENTI - Matt_esterno vasca / pool surround / plage / beckenumgang

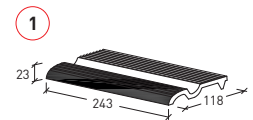
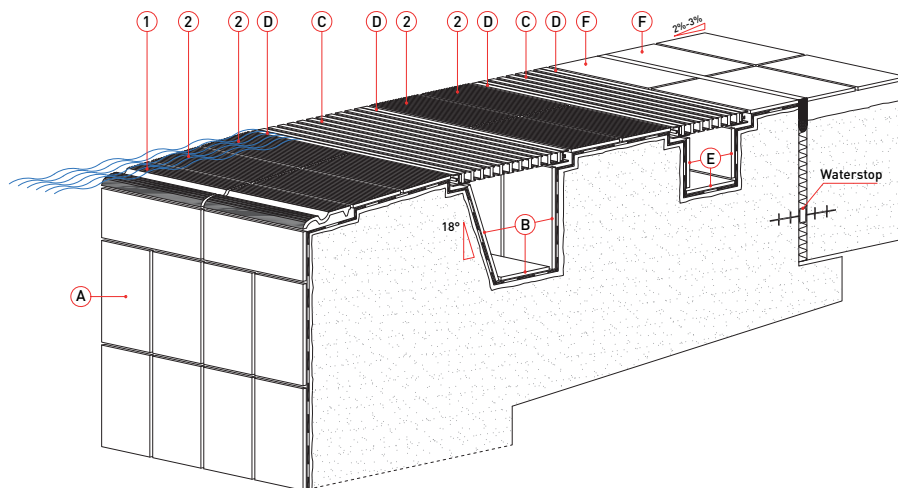

7200 Banda Nera

LANDSCAPE - Rigata

100 Tundra

ELEMENTI - Rigata

010 Talco

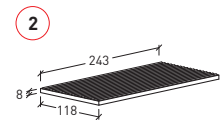

3200

LANDSCAPE - Rigata

100 Tundra

200 Bay

202 Ocean

ELEMENTI - Rigata

010 Talco

011 Avorio

021 Mare

mod. FCC 2200.0

- A LANDSCAPE - Satin_interno vasca / pool tank / interieur bassin / becken
- B LANDSCAPE - Satin_canaletta di ricircolo / overflow channel / caniveau eau bassin / rinne
- C PADANA GRID_griglia in pvc / grating in pvc / grille en pvc / pvc rost
- D PADANA GRID_angolare in pvc / pvc grating support / corniere en pvc / pvc rost traeger
- E LANDSCAPE - Satin_canaletta esterna / external channel / caniveau exterior / aussenrinne
- F ELEMENTI - Matt_esterno vasca / pool surround / plage / beckenumgang

BORDO FINLANDESE TRIM-BOX – SUPERFICIE RIGATA FINNISH POOL BORDER WITH FINGER GRIP – SURFACE RIGATA
TÊTE FINLANDAISE TRADITIONNELLE AVEC ACCROCHE DOIGTS – FINITION RIGATA BECKENKOPF FINNLAND MIT HANDFASS – OBERFLÄCHE RIGATA

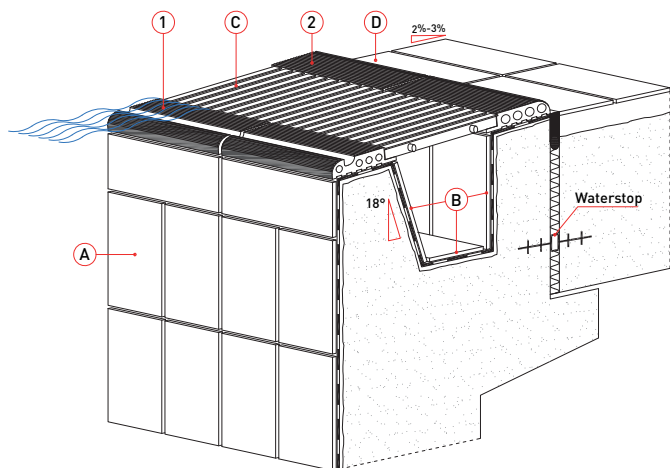

mod. FTR 0121.2
TRIM BOX

- A** LANDSCAPE - Satin_interno vasca / pool tank / interieur bassin / becken
- B** LANDSCAPE - Satin_canaletta di ricircolo / overflow channel / caniveau eau bassin / rinne
- C** PADANA GRID_griglia in pvc / grating in pvc / grille en pvc / pvc rost
- D** ELEMENTI - Matt_esterno vasca / pool surround / plage / beckenumgang

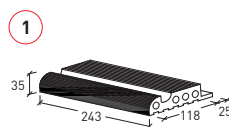

7800 Banda Nera

Trim-Box

LANDSCAPE - Rigata



100 Tundra

ELEMENTI - Rigata



010 Talco

P106-0242

Polyfill cilindro / cylinder / cilindre / Zylinder

(4 pcs)*

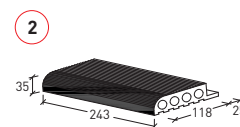

9546 Banda Nera

Trim-Box

LANDSCAPE - Rigata



100 Tundra

ELEMENTI - Rigata



010 Talco

P102-0242

Polyfill cilindro / cylinder / cilindre / Zylinder

(4 pcs)*

* Vedi pagina: See page: Voir page: Siehe Seite: 42

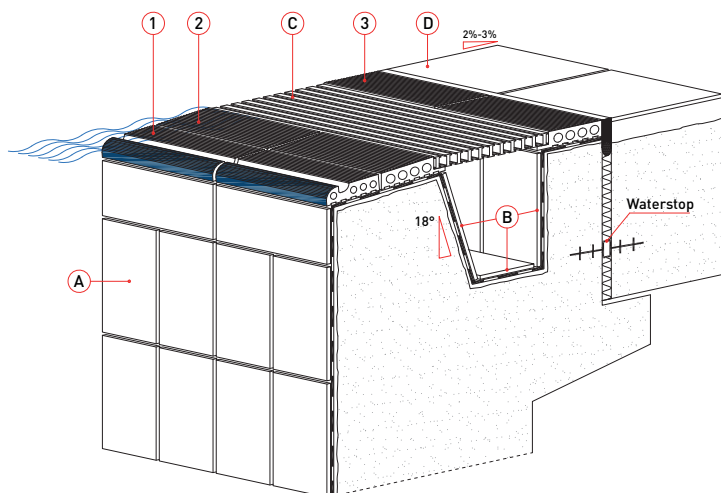

mod. FTR 1121.0
TRIM BOX

- A** LANDSCAPE - Satin_interno vasca / pool tank / interieur bassin / becken
- B** LANDSCAPE - Satin_canaletta di ricircolo / overflow channel / caniveau eau bassin / rinne
- C** PADANA GRID_griglia in pvc / grating in pvc / grille en pvc / pvc rost
- D** ELEMENTI - Matt_esterno vasca / pool surround / plage / beckenumgang

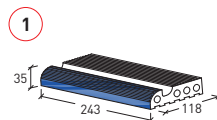

7500 Banda Blu

Trim-Box

LANDSCAPE - Rigata



100 Tundra

ELEMENTI - Rigata



010 Talco

P106-0242

Polyfill cilindro / cylinder / cilindre / Zylinder

(4 pcs)*

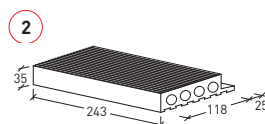

8800

Trim-Box

LANDSCAPE - Rigata



100 Tundra

ELEMENTI - Rigata



010 Talco

P102-0242

Polyfill cilindro / cylinder / cilindre / Zylinder

(4 pcs)*

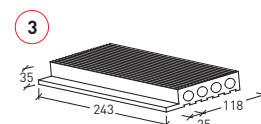

8600

Trim-Box

LANDSCAPE - Rigata



100 Tundra

ELEMENTI - Rigata



010 Talco

P102-0242

Polyfill cilindro / cylinder / cilindre / Zylinder

(4 pcs)*

* Vedi pagina: See page: Voir page: Siehe Seite: 42

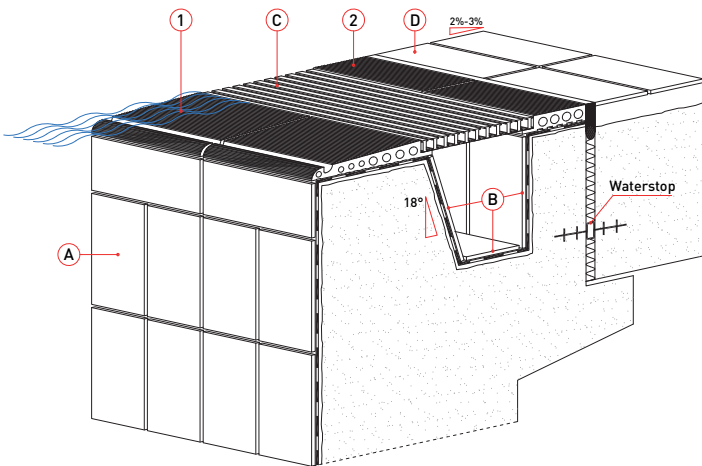
**mod. FTR 0121.3****TRIM BOX**

- A** LANDSCAPE -Satin_interno vasca / pool tank / interieur bassin / becken
B LANDSCAPE - Satin_canaletta di ricircolo / overflow channel / caniveau eau bassin / rinne
C PADANA GRID_griglia in pvc / grating in pvc / grille en pvc / pvc rost
D ELEMENTI -Matt_esterno vasca / pool surround / plage / beckenumgang

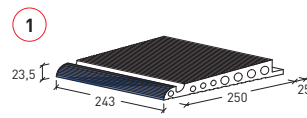
**7700 Banda Blu**

Trim-Box

ELEMENTI - Rigata

010 Talco

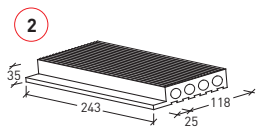
P213-0242Polyfill cilindro / cylinder / cilindre / Zylinder
(4 pcs)***P106-0242**Polyfill cilindro / cylinder / cilindre / Zylinder
(4 pcs)***8600**

Trim-Box

LANDSCAPE - Rigata

100 Tundra

ELEMENTI - Rigata

010 Talco

P102-0242Polyfill cilindro / cylinder / cilindre / Zylinder
(4 pcs)*

* Vedi pagina: See page: Voir page: Siehe Seite: 42

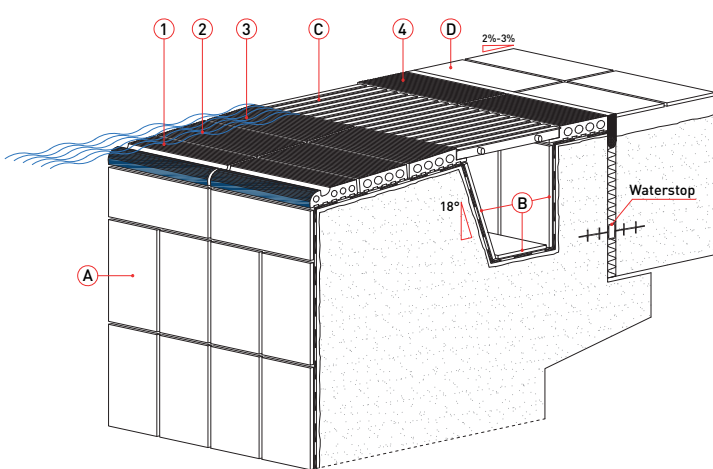
**mod. FTR 2121.0****TRIM BOX**

- A** LANDSCAPE - Satin_interno vasca / pool tank / interieur bassin / becken
B LANDSCAPE - Satin_canaletta di ricircolo / overflow channel / caniveau eau bassin / rinne
C PADANA GRID_griglia in pvc / grating in pvc / grille en pvc / pvc rost
D ELEMENTI - Matt_esterno vasca / pool surround / plage / beckenumgang

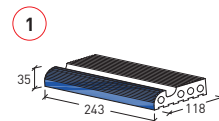
**7500 Banda Blu**

Trim-Box

LANDSCAPE - Rigata

100 Tundra

ELEMENTI - Rigata

010 Talco

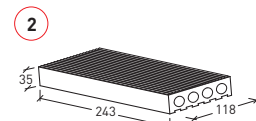
P106-0242Polyfill cilindro / cylinder / cilindre / Zylinder
(4 pcs)***8100**

Trim-Box

LANDSCAPE - Rigata

100 Tundra

ELEMENTI - Rigata

010 Talco

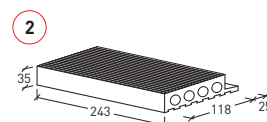
P102-0242Polyfill cilindro / cylinder / cilindre / Zylinder
(4 pcs)***8800**

Trim-Box

LANDSCAPE - Rigata

100 Tundra

ELEMENTI - Rigata

010 Talco

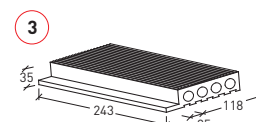
P102-0242Polyfill cilindro / cylinder / cilindre / Zylinder
(4 pcs)***8600**

Trim-Box

LANDSCAPE - Rigata

100 Tundra

ELEMENTI - Rigata

010 Talco

P102-0242Polyfill cilindro / cylinder / cilindre / Zylinder
(4 pcs)*

* Vedi pagina: See page: Voir page: Siehe Seite: 42

Sistema Wiesbaden a pavimento

WIESBADEN SYSTEM - HIGH LEVEL
SYSTEME WIESBADEN SURFLÖT
SYSTEM WIESBADEN HOCHLIEGEND

Il bordo vasca Wiesbaden a pavimento viene utilizzato in genere per vasche indoor quando, per esigenze di spazio, si ha la necessità di contenere la larghezza complessiva del bordo vasca.

Per questo tipo di bordo si possono utilizzare canalette in ceramica monolitiche.

Decisamente più interessante e flessibile risulta invece la soluzione con i pezzi speciali Trim-Box che consentono di dimensionare a piacere la larghezza della canaletta, di creare il lato inclinato per ridurre il rumore dell'acqua e di usare pezzi con colori diversi.

The Wiesbaden high-level system is usually used for indoor pools where, for reasons of space, a reduction of the total width of the pool border is required.

For this kind of pool borders it is possible to use monolithic ceramic channels.

The Trim-Box solution, in turn, is definitely more interesting and flexible, since it allows any width of the channel, a sloping side to reduce the noise of water and use pieces of different colours.

En général, le système Wiesbaden surfloet est utilisé pour bassins d'intérieur où une réduction de la largeur totale de la tête est exigée.

Pour ce type de tête, des goulottes céramiques monobloc.

La solution avec pièces spéciales Trim-Box est toutefois plus intéressante et flexible, vu qu'elle permet de créer une goulotte dimensionnée en largeur selon les exigences, en plus d'introduire un pan coupé réduisant le bruit de l'eau et d'habiller avec pièces en couleurs différentes.

Die Wiesbadener Rinne mit hochliegendem Wasserspiegel wird normalerweise bei Innenpools verwendet, besteht aus Patzgründen die Notwendigkeit, die Gesamtbreite des Beckenrandes zu beschränken.

Für diese Art von Beckenrand Keramik-Rinnen verwendet werden.

Wesentlich interessanter und flexibler ist hingegen die Lösung mit Trim-Box-Formteilen, die eine beliebige Dimensionierung der Rinnenbreite, die Konstruktion einer Seitenneigung zur Reduzierung des Wasserrauschens und die Verwendung von verschiedenfarbigen Teilen ermöglicht.

sistema wiesbaden a pavimento / wiesbaden system - high level /
système wiesbaden surflot / system wiesbaden hochliegend



Sistema wiesbaden a pavimento Trim-Box Wiesbaden system - high level Trim-Box Système wiesbaden surflot Trim-Box System wiesbaden hochliegend Trim-Box

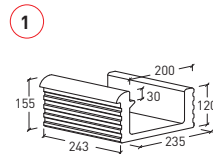
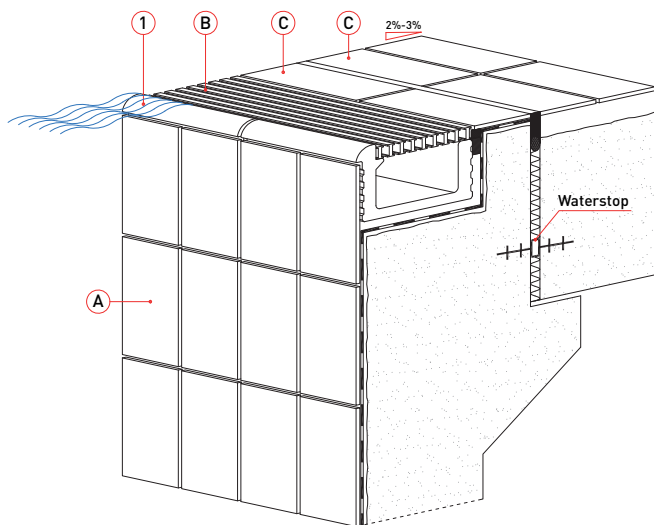

6600
LANDSCAPE - Satin
 100 Tundra

mod. WSC 0121.0

- A LANDSCAPE - Satin_interno vasca / pool tank / interieur bassin / becken
- B PADANA GRID_griglia in pvc / grating in pvc / grille en pvc / pvc rost
- C ELEMENTI - Matt_esterno vasca / pool surround / plage / beckenumgang

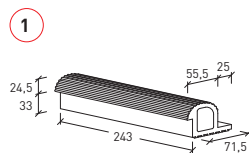
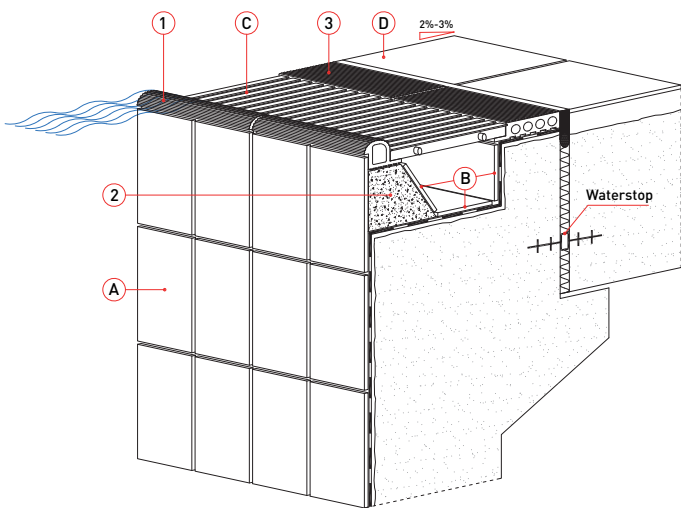

6550
Trim-Box
ELEMENTI - Rigata
 010 Talco 021 Mare

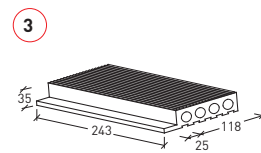

8600
Trim-Box
LANDSCAPE - Rigata
 100 Tundra

P104-0242
 Polyfill **profilo / profile / profil / Profil**
(1 pc)*

ELEMENTI - Rigata
 010 Talco

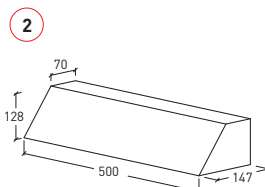

6415
Betonbuild

P102-0242
 Polyfill **cilindro / cylinder / cilindre / Zylinder**
(4 pcs)*

mod. WSC CLS
TRIM-BOX

- A LANDSCAPE - Satin_interno vasca / pool tank / interieur bassin / becken
- B LANDSCAPE - Satin_canaletta di ricircolo / overflow channel / caniveau eau bassin / rinne
- C PADANA GRID_griglia in pvc / grating in pvc / grille en pvc / pvc rost
- D ELEMENTI - Matt_esterno vasca / pool surround / plage / beckenumgang

* Vedi pagina: See page: Voir page: Siehe Seite: 42

sistema wiesbaden a pavimento / wiesbaden system - high level /
système wiesbaden surflot / system wiesbaden hochliegend

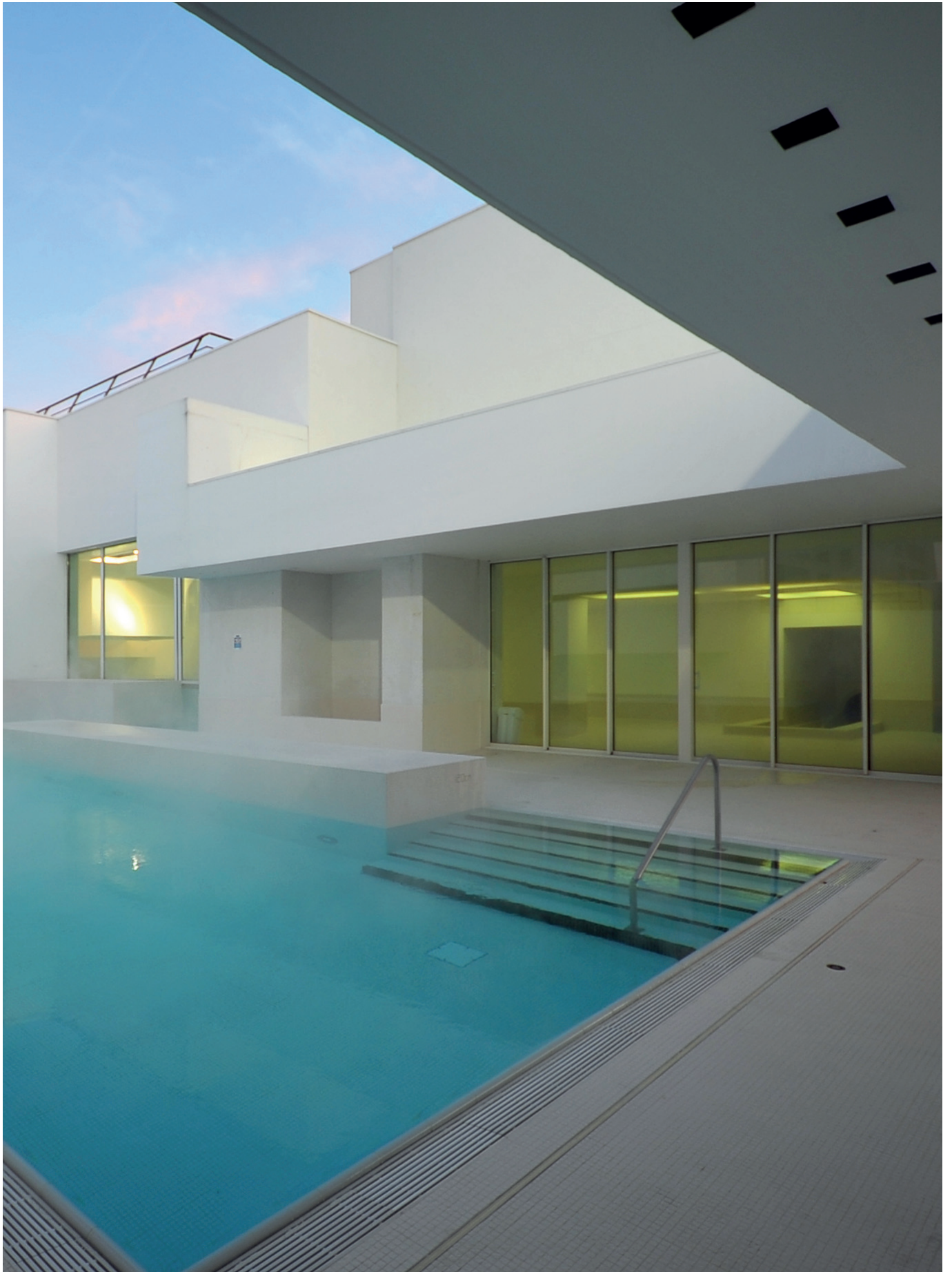

Sistema Wiesbaden a parete

WIESBADEN SYSTEM - LOW LEVEL
SYSTEME WIESBADEN EN PAROI
SYSTEM WIESBADEN TIEFLIEGEND

Il sistema Wiesbaden nella versione a parete lascia completamente libero il bordo superiore della vasca che quindi non necessita di particolari pezzi speciali di finitura.

E' un sistema di vecchia concezione che oggigiorno viene installato prevalentemente per vasche particolari come quelle terapeutiche o di arrivo scivoli.

The Wiesbaden low-level system, leaves the upper wall of the pool border completely free and do not require any particular fitting.

This is a old-fashioned system almost exclusively used for specific pools such as therapeutic or slide-equipped pools.

Le système Wiesbaden en paroi laisse la partie supérieure du bassin libre, qui n'exige, par conséquent, aucune pièce spéciale de finition particulier.

Il s'agit d'un système aujourd'hui utilisé presque exclusivement pour des bassins particuliers tels que ceux thérapeutiques ou les bassins de réception toboggan.

Die Wiesbadener Rinne mit tiefliegendem Wasserspiegel lässt den oberen Beckenrand vollkommen frei. Dieser benötigt daher keine besonderen Beckenrandteile.

Es handelt sich um ein veraltetes System, das heutzutage vorwiegend in besonderen Becken, wie Therapie- oder Rutschbecken, installiert wird.



sistema wiesbaden a parete / wiesbaden system - low level /
système wiesbaden en paroi / system wiesbaden tiefliegend

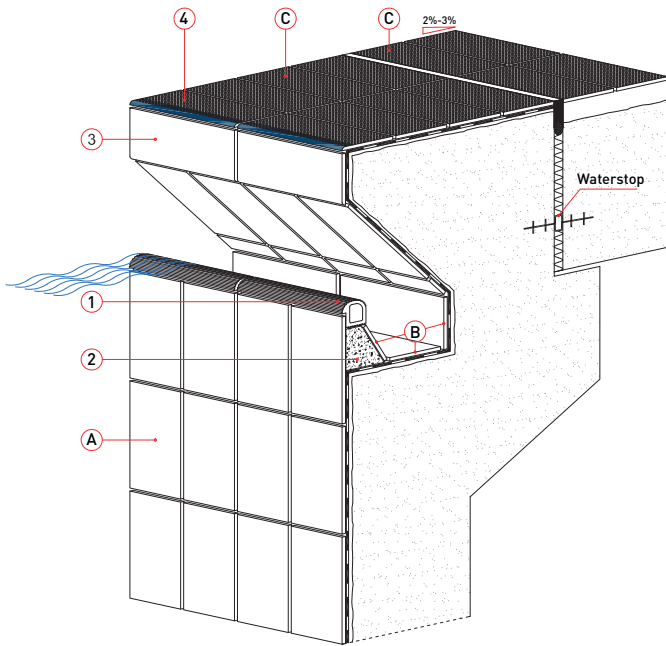

mod. WSP 0131.17

TRIM-BOX

- A LANDSCAPE - Satin_interno vasca / pool tank / interieur bassin / becken
- B LANDSCAPE - Satin_canaletta di ricircolo / overflow channel / caniveau eau bassin / rinne
- C ELEMENTI - Pinhead_esterno vasca / pool surround / plage / beckenumgang

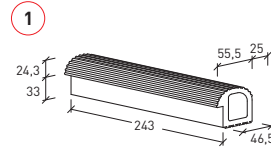

6050
Trim-Box
ELEMENTI - Rigata
010 Talco 021 Mare

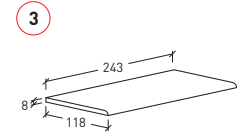

1106
LANDSCAPE - Satin
100 Tundra 200 Bay 202 Ocean

P104-0242
Polyfill profilo / profile / profil / Profil (1 pc)*

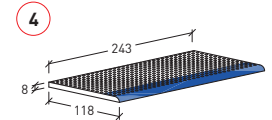

3356 Banda Blu
ELEMENTI - Pinhead
010 Talco 011 Avorio

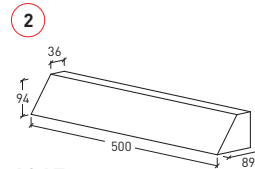

6315
Betonbuild

* Vedi pagina: See page: Voir page: Siehe Seite: 42

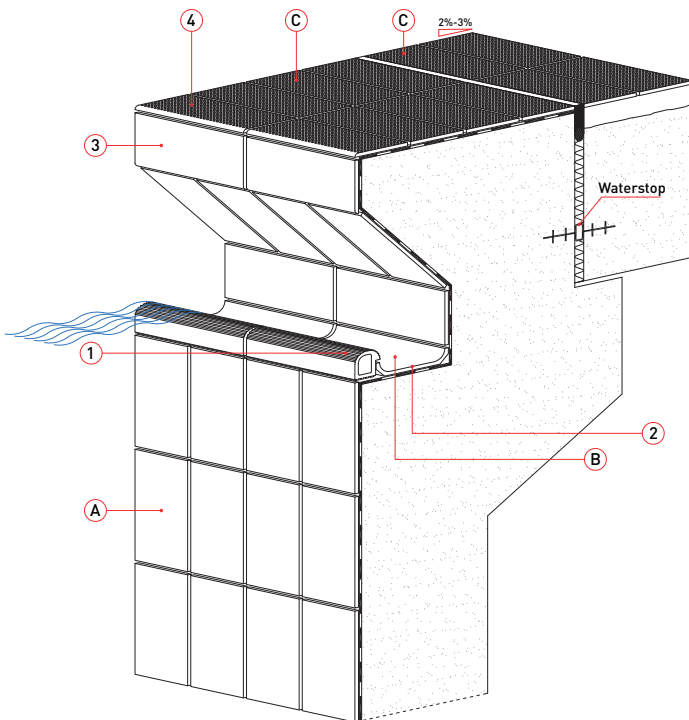

mod. WSP 0131.7

TRIM-BOX

- A LANDSCAPE - Satin_interno vasca / pool tank / interieur bassin / becken
- B LANDSCAPE - Satin_canaletta di ricircolo / overflow channel / caniveau eau bassin / rinne
- C ELEMENTI - Pinhead_esterno vasca / pool surround / plage / beckenumgang

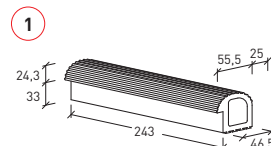

6050
Trim-Box
ELEMENTI - Rigata
010 Talco 021 Mare

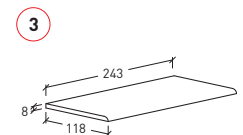

1106
LANDSCAPE - Satin
100 Tundra 200 Bay 202 Ocean

P104-0242
Polyfill profilo / profile / profil / Profil (1 pc)*

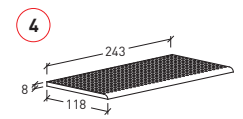

1106
ELEMENTI - Pinhead
010 Talco 011 Avorio 021 Mare
060 Cemento 061 Basalto 070 Ebano

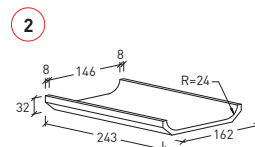

4700
Padana-Deck

LANDSCAPE - Satin
100 Tundra

* Vedi pagina: See page: Voir page: Siehe Seite: 42

Sistema St. Moritz

ST. MORITZ SYSTEM
SYSTEME ST. MORITZ
SYSTEM ST. MORITZ

Il bordo vasca St. Moritz è in genere utilizzato per vasche terapeutiche oppure quando, per ragioni tecniche, è necessario avere una parte della vasca fuori terra.

Le sua funzionalità si presta inoltre a creare suggestivi effetti cascata anche in vasche ludiche e ricreative.

La canaletta di recupero dell'acqua sottostante allo sfioro può essere poi realizzata sia con pezzi tradizionali che con pezzi speciali del sistema Trim-Box.

The St. Moritz system is mainly used for therapeutic pools or when, due to technical requirements, a part of the pool must remain above ground level.

Its functionality is also perfect to fashion suggestive effects in leisure and recreational pools.

The channel underneath the overflow can be made both with traditional fittings or Trim-Box system pieces.

La tête de bassin St. Moritz est surtout utilisée pour les bassins thérapeutiques ou lors des exigences techniques imposent des piscines hors sol.

Sa fonctionnalité permet aussi de créer de suggestifs effets cascade pour les bassins ludiques.

La goulotte de récupération de l'eau au-dessous du débordement peut être réalisée avec des pièces traditionnelles ou des pièces spéciales du système Trim-Box.

Die St. Moritz-Rinne wird im Allgemeinen für Therapiebecken verwendet oder wenn es aus technischen Gründen erforderlich ist, dass ein Teil des Beckens aus dem Boden herausragt.

Dank ihrer Funktionsweise eignet sie sich außerdem in Spiel- und Freizeitbecken zur Erzeugung faszinierender Wasserfalleffekte.

Die unter dem Überlauftrand liegende Schwallwasserrinne kann sowohl mit traditionellen Teilen als auch mit Formteilen des Trim-Box-Systems verwirklicht werden.



sistema St. Moritz / St. Moritz system /
système St. Moritz / system St. Moritz

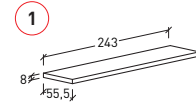
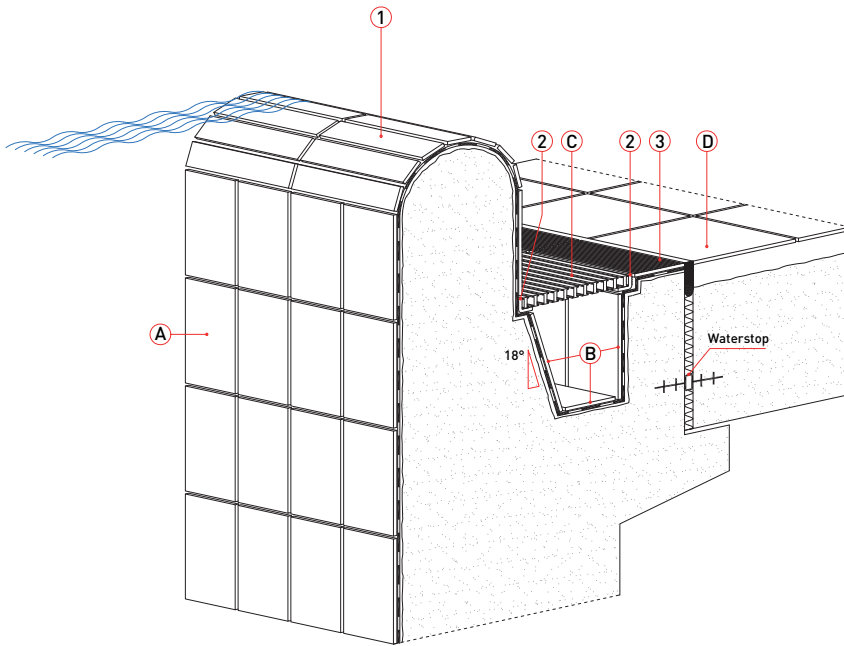

LANDSCAPE - Satin

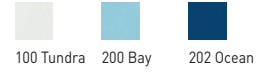

2

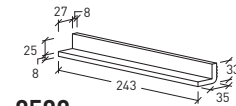

0500

Padana-Grid

LANDSCAPE - Satin



3

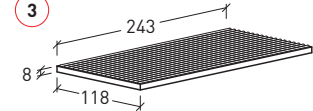

3200

LANDSCAPE - Rigata



ELEMENTI - Rigata



mod. SM 0101.1

- A LANDSCAPE - Satin_interno vasca / pool tank / interieur bassin / becken
- B LANDSCAPE - Satin_canaletta di ricircolo / overflow channel / caniveau eau bassin / rinne
- C PADANA GRID_griglia in pvc / grating in pvc / grille en pvc / pvc rost
- D LANDSCAPE - Satin_esterno vasca / pool surround / plage / beckenumgang

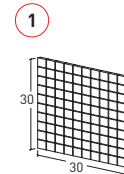
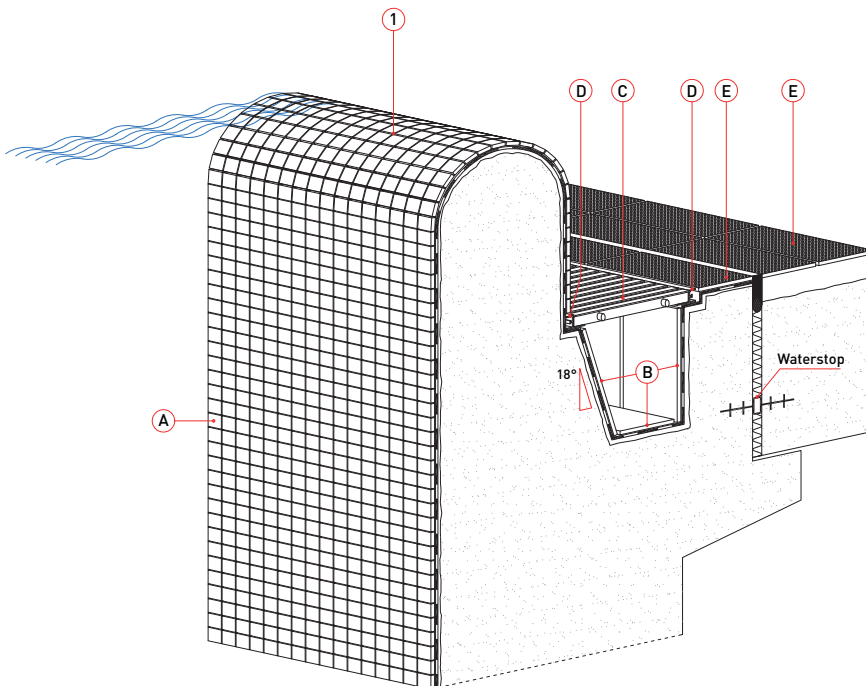

2700 - MOSAICI LS Uni

LANDSCAPE - Satin



Vedi pagina: See page: Voir page: Siehe Seite: 28

mod. SM 0101.2

- A LANDSCAPE - Satin_interno vasca / pool tank / interieur bassin / becken
- B LANDSCAPE - Satin_canaletta di ricircolo / overflow channel / caniveau eau bassin / rinne
- C PADANA GRID_griglia in pvc / grating in pvc / grille en pvc / pvc rost
- D PADANA GRID_angolare in pvc / pvc grating support / corniere en pvc / pvc rost traeger
- E ELEMENTI - Pinhead_esterno vasca / pool surround / plage / beckenumgang

Sistema Skimmer

SKIMMER SYSTEM
SYSTEME SKIMMERS
SYSTEM SKIMMER

Il sistema a Skimmer ha una funzionalità diversa da quella delle piscine con sfioro superficiale e viene in genere utilizzato per piscine private o comunque di piccole dimensioni.

Le funzioni del pezzo di bordo vasca sono essenzialmente quelle di evitare che l'acqua presente sul piano vasca entri nella piscina e di fornire un aggrappo agli utilizzatori.

The skimmer system has a different function from overflow systems and is normally used for private or reduced-size pools.

The edging pieces serve essentially as finger grip and to prevent water from the pool deck entering into the pool.

Le système à skimmer a une fonction différente par rapport à celle des piscines à débordement de surface et il est normalement utilisé pour les piscines privées ou, en tout cas, aux dimensions réduites.

La pièce de bordure sert essentiellement d'accroche-doigts et à empêcher à l'eau de plage de pénétrer dans la piscine.

Das Skimmer-System hat eine Funktionsweise, die sich von der Funktion der Schwimmbecken mit ständiger Abnahme des Oberflächenwassers unterscheidet, und wird im Allgemeinen in privaten oder kleinen Schwimmbecken verwendet.

Der Beckenkopf hat hauptsächlich die Funktion zu verhindern, dass das auf der Beckenplatte vorhandene Wasser in den Pool zurück läuft, sowie dem Badegast als Handfasse zu dienen.



sistema skimmer / skimmer system /
système skimmers / system skimmer

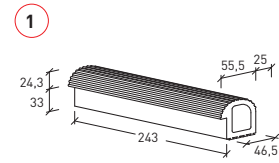
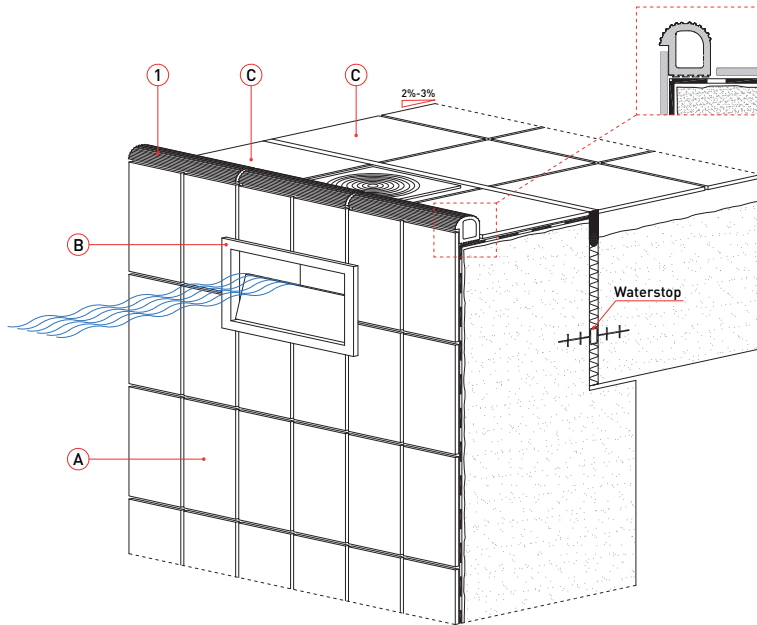

6050

Trim-Box

ELEMENTI - Rigata

010 Talco 021 Mare

P104-0242

Polyfill profilo / profile / profil / Profil
(1 pc)*

* Vedi pagina: See page: Voir page: Siehe Seite: 42

mod. SK 6050

TRIM-BOX

- A LANDSCAPE - Satin_interno vasca / pool tank / interieur bassin / becken
- B Skimmer
- C ELEMENTI - Matt_esterno vasca / pool surround / plage / beckenumgang

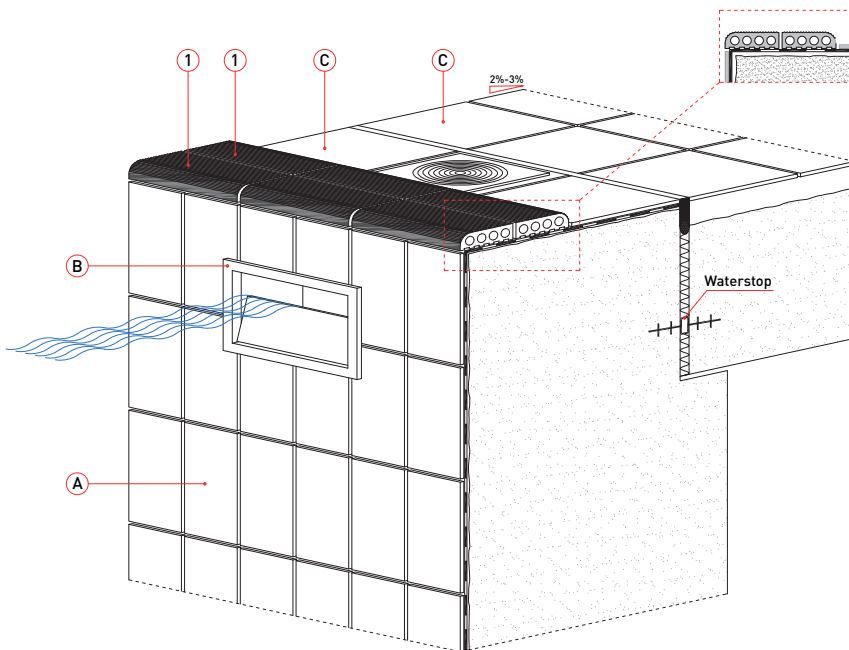

9046 Banda Nera

Trim-Box 6 pc/box 1,8 kg/pc 4 pc/ml

LANDSCAPE - Rigata

100 Tundra

ELEMENTI - Rigata

010 Talco

P102-0242

Polyfill cilindro / cylinder / cilindre / Zylinder
(4 pcs)*

* Vedi pagina: See page: Voir page: Siehe Seite: 42

mod. SK 9046

TRIM-BOX

- A LANDSCAPE - Satin_interno vasca / pool tank / interieur bassin / becken
- B Skimmer
- C ELEMENTI - Matt_esterno vasca / pool surround / plage / beckenumgang

Muretti di testata

STARTING HEADWALLS
QUAIS DE DEPART
STIRNWÄNDE

I muretti di testata, generalmente disposti sui lati corti delle vasche sportive, sono una modalità costruttiva spesso preferita in quanto più economici rispetto ai bordi a sfioro.

I muretti di testata hanno generalmente una larghezza di 50 cm, un'altezza dal livello dell'acqua di 30 cm ed una superficie con grado di antiscivolo a piedi nudi di gruppo C.

È consigliabile realizzare muretti di larghezza non inferiore a 35/40 cm per consentire la collocazione dei blocchi di partenza prefabbricati.

Per avere un miglior risultato estetico e per ottimizzare i tempi e i costi si suggerisce che larghezza e lunghezza dei muretti siano modulari a piastrelle e a pezzi speciali interi.

Starting headwalls arranged on the short sides of sports pools are generally used because they are cheaper compared to overflow.

Starting headwalls usually are 50-cm wide, with a height of about 30 cm on water level and a group C non-slip barefoot surface coefficient.

It is recommended to make sure the headwalls are no less than 35/40 cm wide in order to have the necessary space to install the prefabricated starting blocks.

To have a better aesthetic result and optimise times and costs, it is suggested that headwall width and length be modular to full tiles and fittings.

Les quais de départ, d'habitude disposés sur les cotés courts des bassins sportifs sont assez utilisés car ils sont normalement plus économiques par rapport à la majorité des têtes de bassin à débordement.

Les quais de départ ont d'habitude une largeur de 50 cm, une hauteur minimale de 30 cm sur le niveau d'eau et une surface horizontale avec un coefficient antidérapant pieds nus de group C.

On peut prévoir des largeurs inférieures mais on recommande au moins une largeur de 35/40 cm pour disposer de la place nécessaire à poser les plots de départ préfabriqués.

Pour les réaliser, il est préférable que largeur et longueur soient modulaires, à carreaux et/ou pièces spéciales entières, dans le but d'optimiser temps et couts de construction et d'obtenir un résultat esthétique supérieur.

Die Stirnwände, die sich normalerweise an den kurzen Seiten der Sportschwimmbecken befinden, stellen eine aufgrund der geringeren Kosten im Vergleich zu den Überlaufändern häufig bevorzugte Bauweise dar.

Die Stirnwände haben im Allgemeinen eine Breite von 50 cm, eine Höhe über dem Wasserspiegel von 30 cm und eine Oberfläche mit einem Rutschfestigkeitskoeffizienten der Gruppe C bei barfußigem Betreten.

Die Konstruktion von Stirnwänden mit einer Mindestbreite von 35/40 cm ist empfehlenswert, damit die vorgefertigten Startblöcke plaziert werden können.

Für ein besseres ästhetisches Ergebnis und zur Optimierung der Zeiten und der Kosten wird eine modulare Breite und Länge der Stirnwände aus Fliesen und ganzen Formteilen empfohlen.



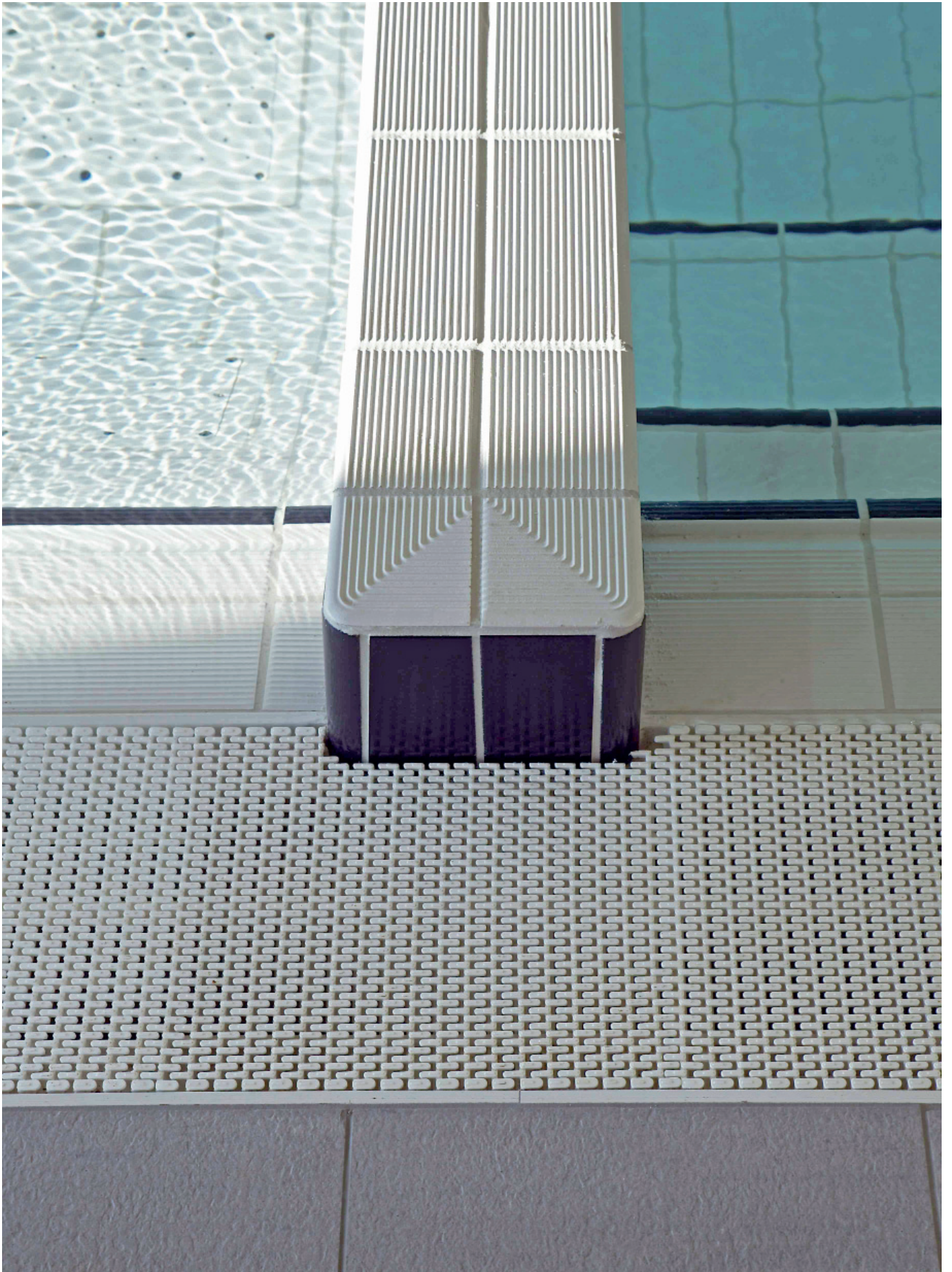

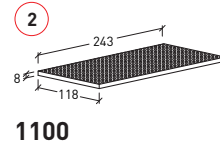
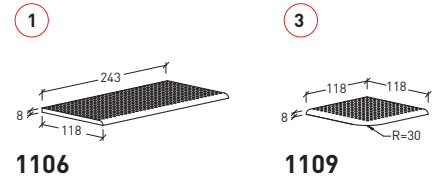
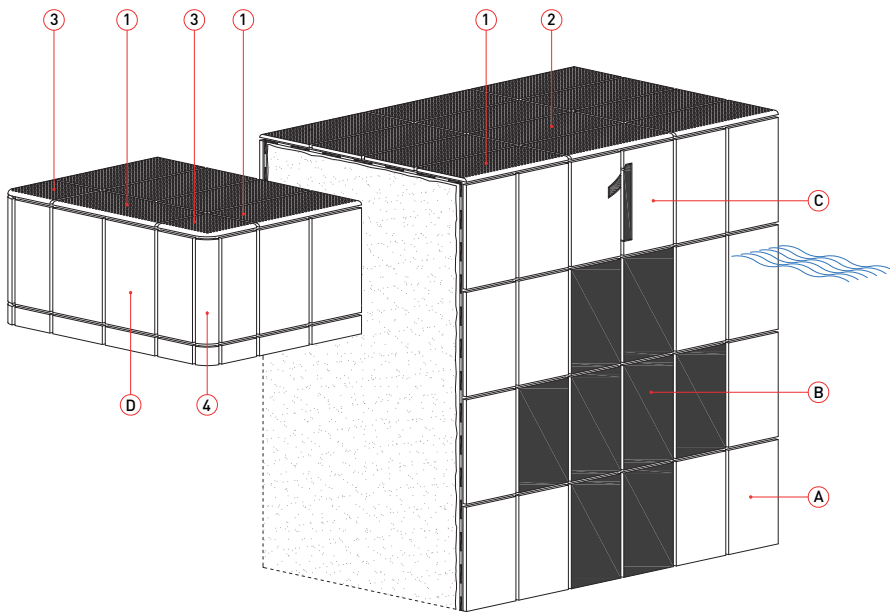

ELEMENTI - Pinhead

010 Talco	011 Avorio	021 Mare
060 Cemento	061 Basalto	070 Ebano

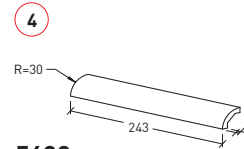

5630

LANDSCAPE - Satin

100 Tundra	200 Bay	202 Ocean
501 Bahama	700 Lava	701 Artic

mod. QD 50.4

- A** LANDSCAPE - Friction_fascia di virata / turning area / zone de virage / wendeflaeche
- B** LANDSCAPE - Friction_vie di corsa / marking lanes / ligne de nage / bahnmarkierungen
- C** LANDSCAPE_piastrelle numerate / numbered tiles / carreau numerote / nummerierte platte
- D** LANDSCAPE - Satin_rivestimento esterno / external wall / revetement exterieur / wandbekleidung

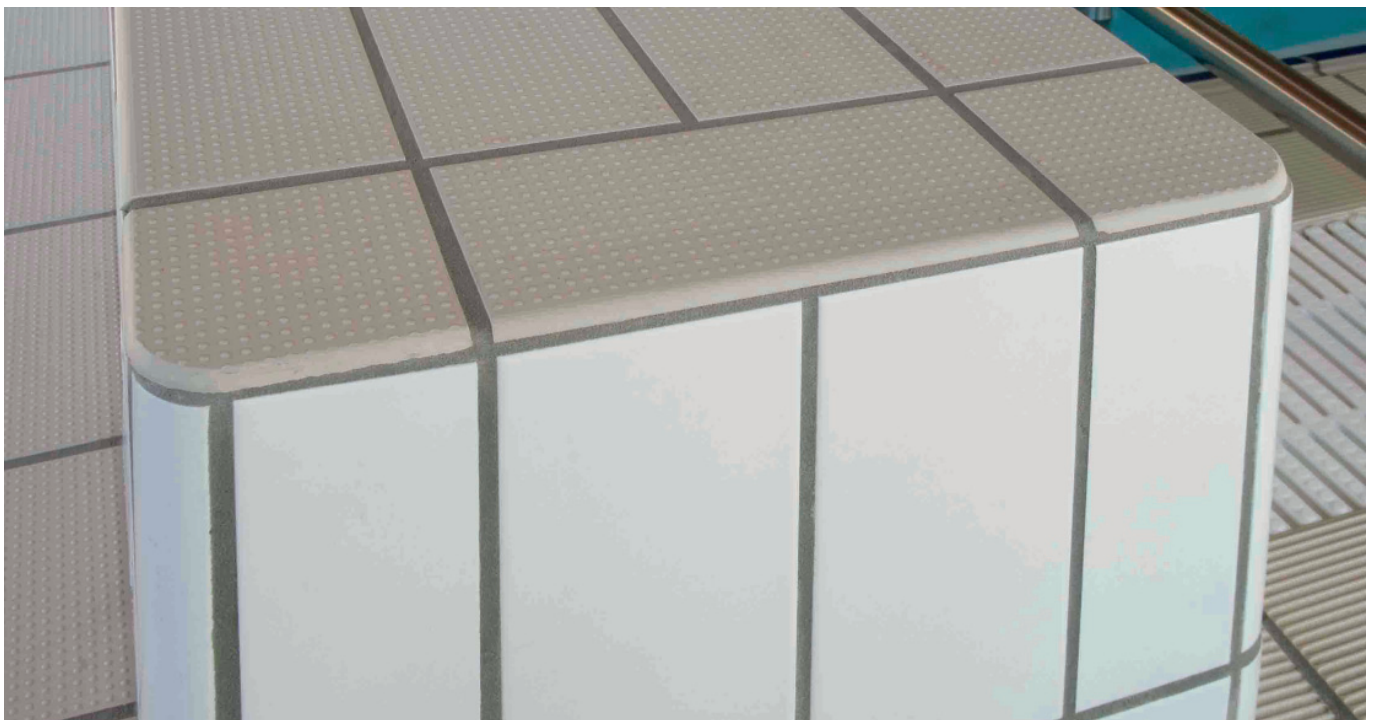

muretti di testata / starting headwalls / quais de départ / stirnwände

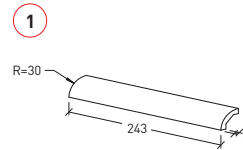
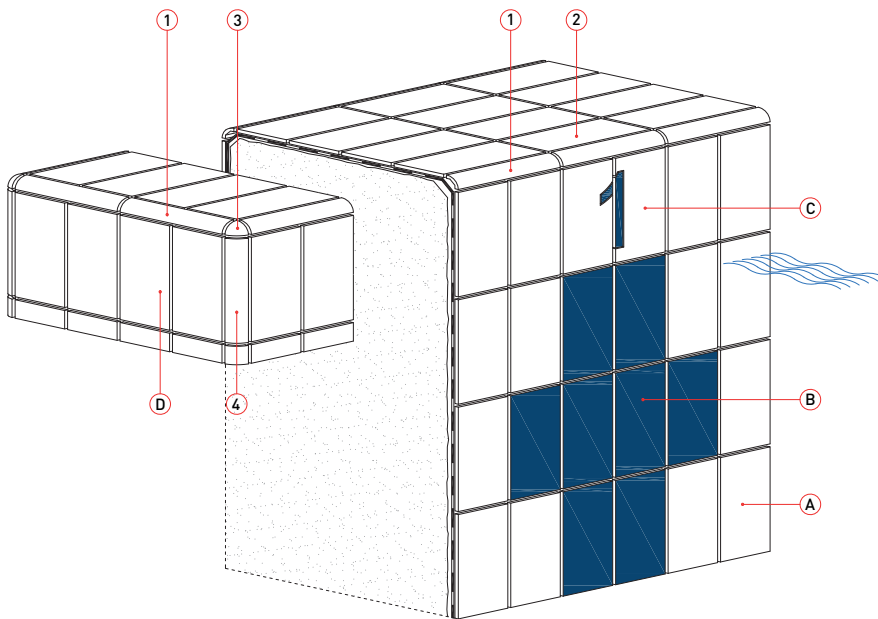
**5630**

LANDSCAPE - Grip

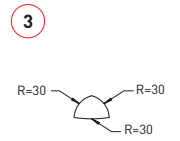
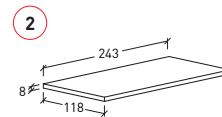
**5607****1100**

LANDSCAPE - Grip

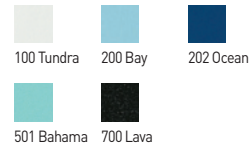
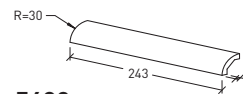
**4****5630**

LANDSCAPE - Satin

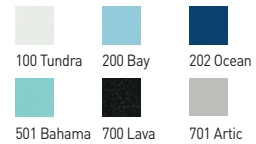
**mod. QD 56.0**

- A** LANDSCAPE - Friction_fascia di virata / turning area / zone de virage / wendeflaeche
B LANDSCAPE - Friction_vie di corsa / marking lanes / ligne de nage / bahnmarkierungen
C LANDSCAPE_piastrelle numerate / numbered tiles / carreau numerote / nummerierte platte
D LANDSCAPE - Satin_rivestimento esterno / external wall / revetement exterieur / wandbekleidung



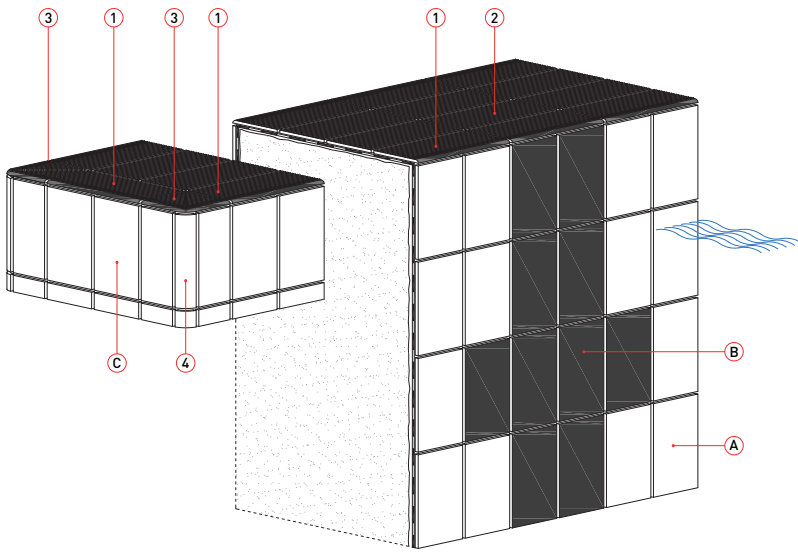

mod.QD 50.8

- A** LANDSCAPE - Friction_fascia di virata / turning area / zone de virage / wendeflaeche
- B** LANDSCAPE - Friction_vie di corsa / marking lanes / ligne de nage / bahnamarkierungen
- C** LANDSCAPE - Satin_rivestimento esterno / external wall / revetement exterieur / wandbekleidung

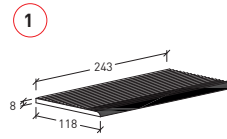

3346 Banda Nera

LANDSCAPE - Rigata



ELEMENTI - Rigata

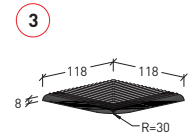

3349 Banda Nera

LANDSCAPE - Rigata



ELEMENTI - Rigata

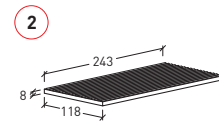

3200

LANDSCAPE - Rigata



ELEMENTI - Rigata

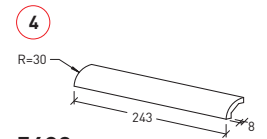

5630

LANDSCAPE - Satin

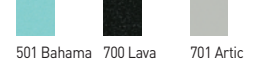

muretti di testata / starting headwalls / quais de départ / stirnwände

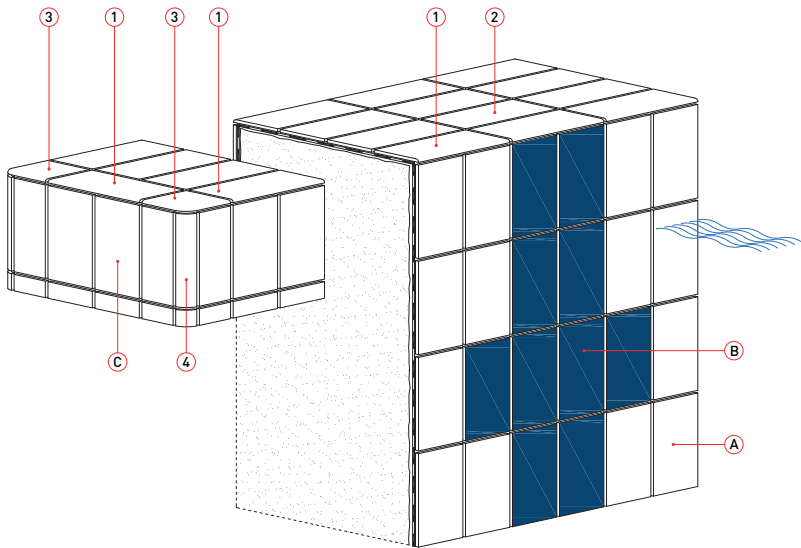

mod. QD 50.9

- A LANDSCAPE - Friction_fascia di virata / turning area / zone de virage / wendeflaeche
- B LANDSCAPE - Friction_vie di corsa / marking lanes / ligne de nage / bahnmrkierungen
- C LANDSCAPE - Satin_rivestimento esterno / external wall / revetement exterieur / wandbekleidung

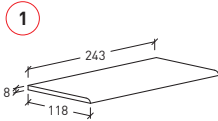

1106

LANDSCAPE - Grip

- 100 Tundra
- 200 Bay
- 202 Ocean
- 700 Lava

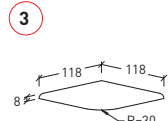

1109

LANDSCAPE - Grip

- 100 Tundra
- 200 Bay
- 202 Ocean
- 700 Lava

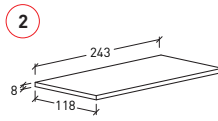

1100

LANDSCAPE - Grip

- 100 Tundra
- 200 Bay
- 202 Ocean
- 501 Bahama
- 700 Lava

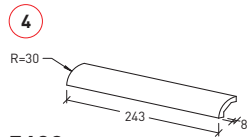

5630

LANDSCAPE - Satin

- 100 Tundra
- 200 Bay
- 202 Ocean
- 501 Bahama
- 700 Lava
- 701 Artic

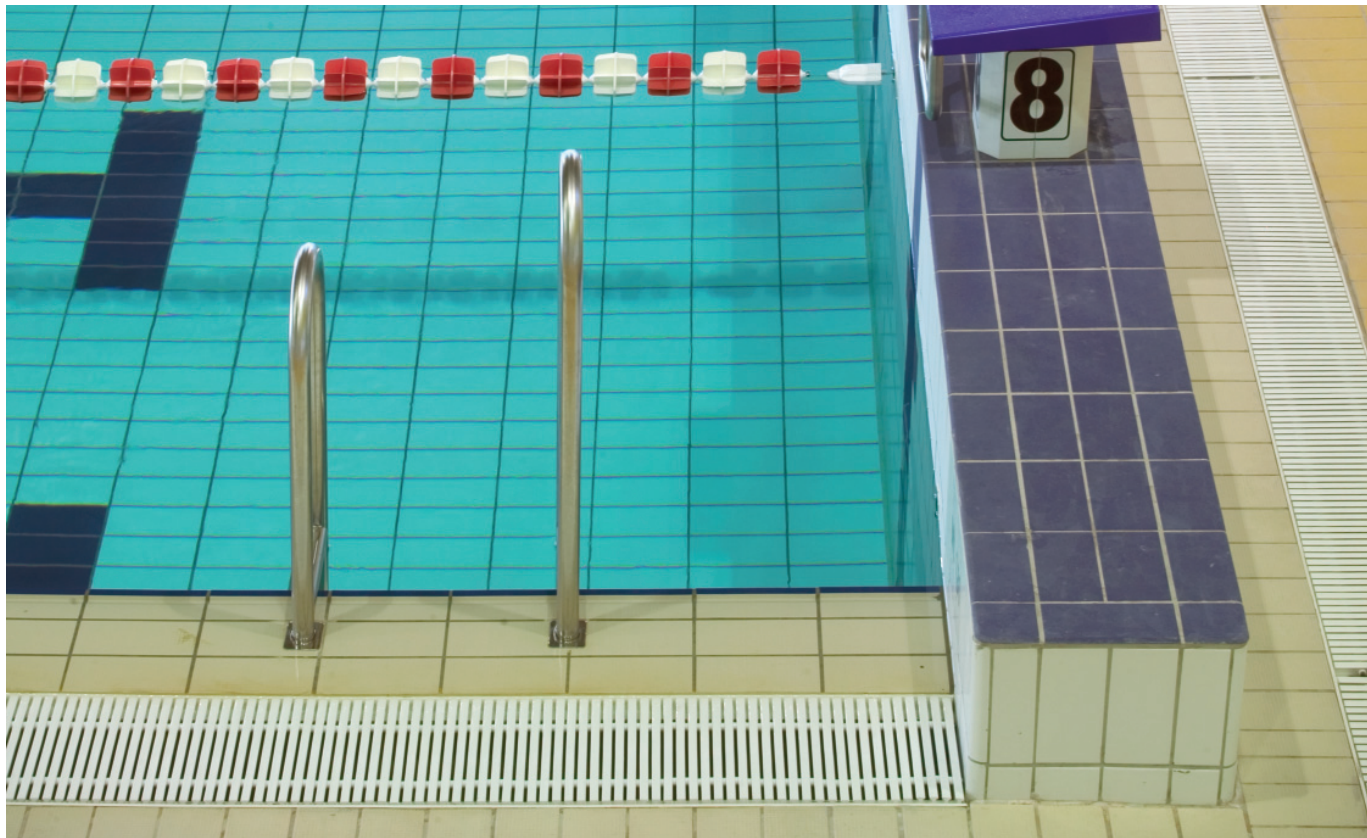

Scale e gradini

STAIRS AND STEPS
ESCALIERS ET MARCHES
TREPPEN UND STUFEN

La normativa esige che le scale e i gradini degli impianti natatori abbiano una superficie con un grado di antiscivolosità a piedi nudi di gruppo B quando sono esterni alle vasche e di gruppo C quando sono immersi in acqua.

Per ragioni di sicurezza si deve sempre evitare la presenza di spigoli vivi o taglienti e, per le scale immerse in acqua, è necessario sempre prevedere strisce di colore a contrasto sulla parte terminale delle pedate per evidenziare il cambio di profondità tra un gradino e l'altro.

L'ampia gamma di pezzi speciali e di tipologie di superfici permette di realizzare moduli con pedate di 25 cm, 27,5 cm, 30 cm, 37,5 cm e 50 cm senza necessità di operare nessun taglio.

In public pools, the regulation recommends that stairs and steps have a group B barefoot non-slip surface coefficient if they are located outside of water and group C when immersed into water.

For security reasons when it comes to submerged stairs, it is also very important to avoid sharp edges and to provide for contrasting colour stripes on the end-portion of the steps in order to signal the change of depth between one and the next.

The wide range of fittings and available surface types allows for steps of 25 cm, 27.5 cm, 30 cm, 37.5 cm and 50 cm without any cut.

Dans les piscines recevant du public, la norme prévoit que les escaliers et les marches aient une surface antidérapante pieds nus de group B s'ils sont situés hors d'eau et de group C quand immergés dans l'eau.

Pour des raisons de sécurité il est aussi très important d'éviter les arêtes vives et, en ce qui concerne les escaliers plongés dans l'eau, de réaliser les nez-de-marche avec marquage de sécurité pour mieux voir la différence de profondeur.

L'ample gamme des pièces spéciales et des surfaces disponibles permet de réaliser des marches de 25 cm, 27,5 cm, 30 cm, 37,5 cm et 50 cm sans aucune coupe.

Die Bestimmungen fordern, dass die sich außerhalb der Becken befindenden Treppen und Stufen der Schwimmanlagen eine Oberfläche mit einem Rutschfestigkeitskoeffizienten der Gruppe B bei barfüßigem Betreten haben müssen, während die unter Wasser liegenden Treppen und Stufen einen Rutschfestigkeitskoeffizienten der Gruppe C aufweisen müssen.

Aus Sicherheitsgründen sind scharfe oder schneidende Kanten stets zu vermeiden, und bei den Unterwassertreppen müssen die Enden der Trittstufen immer mit kontrastierenden Farbstreifen versehen sein, um die Tiefenänderung zwischen beiden Stufen hervorzuheben.

Das breite Sortiment an Formteilen und Oberflächenausführungen ermöglicht die Konstruktion von Teilen mit Trittstufen von 25 cm, 27,5 cm, 30 cm, 37,5 cm und 50 cm, ohne dabei Schnitte vornehmen zu müssen.



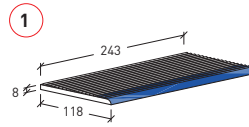
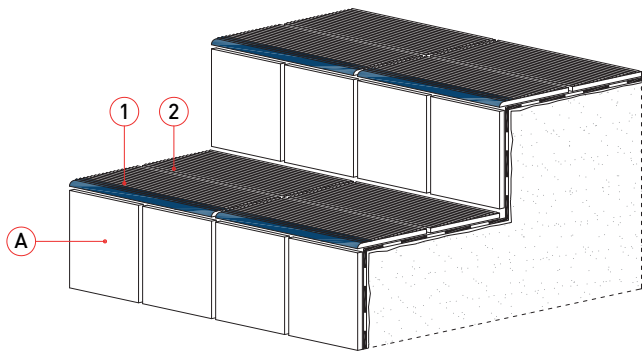

3346 Banda Blu

LANDSCAPE - Rigata

100 Tundra

ELEMENTI - Rigata

010 Talco

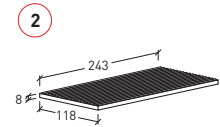

3200

LANDSCAPE - Rigata

100 Tundra 200 Bay 202 Ocean

ELEMENTI - Rigata

010 Talco 011 Avorio 021 Mare

mod. SC 25.0

A LANDSCAPE - Satin / ELEMENTI - Matt_alzata / riser / contremarche / setzstufe

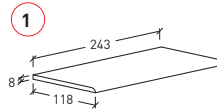
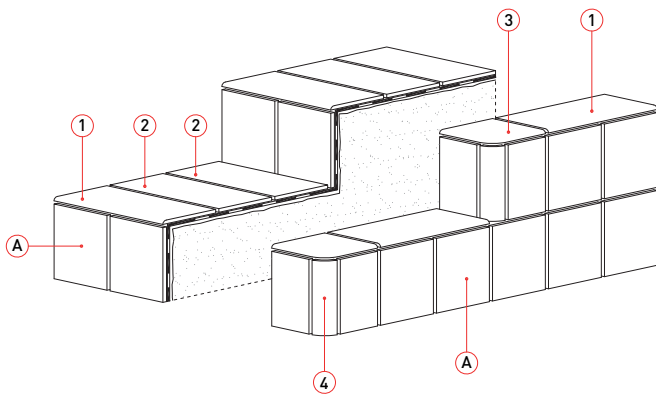

1106

LANDSCAPE - Grip

100 Tundra 200 Bay 202 Ocean

700 Lava

ELEMENTI - Matt

010 Talco 011 Avorio 021 Mare

060 Cemento 061 Basalto 070 Ebano

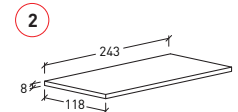

1100

LANDSCAPE - Grip

100 Tundra 200 Bay 202 Ocean

501 Bahama 700 Lava

ELEMENTI - Matt

010 Talco 011 Avorio 021 Mare

060 Cemento 061 Basalto 070 Ebano

mod. SC 37.0

A LANDSCAPE - Satin / ELEMENTI - Matt_alzata / riser / contremarche / setzstufe



1109

LANDSCAPE - Grip

100 Tundra 200 Bay 202 Ocean

ELEMENTI - Matt

010 Talco 011 Avorio 021 Mare

060 Cemento 061 Basalto 070 Ebano

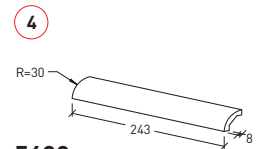

5630

LANDSCAPE - Satin

100 Tundra 200 Bay 202 Ocean

501 Bahama 700 Lava 701 Artic

ELEMENTI - Matt

010 Talco 011 Avorio 060 Cemento

scale e gradini / stairs and steps / escaliers et marches / treppen und stufen

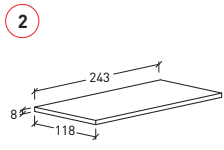
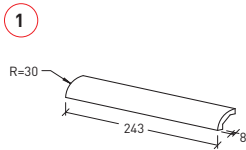
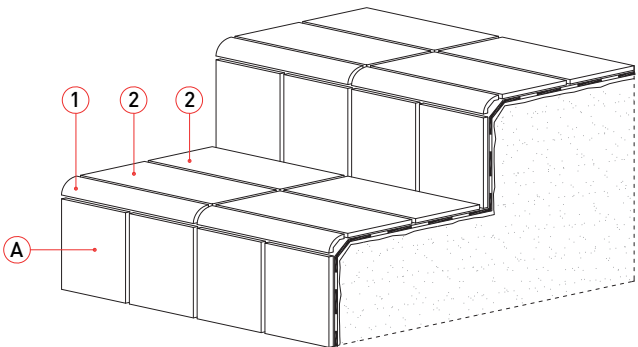

5630

LANDSCAPE - Grip

- 
 100 Tundra
- 
 202 Ocean
- 
 700 Lava

ELEMENTI - Matt



- 
 010 Talco
- 
 011 Avorio
- 
 060 Cemento

1100

LANDSCAPE - Grip

- 
 100 Tundra
- 
 200 Bay
- 
 202 Ocean

ELEMENTI - Matt

- 
 501 Bahama
- 
 700 Lava

ELEMENTI - Matt

- 
 010 Talco
 - 
 011 Avorio
 - 
 021 Mare
- 
 060 Cemento
 - 
 061 Basalto
 - 
 070 Ebanò

mod. SC 27.2

A LANDSCAPE - Satin / ELEMENTI - Matt_alzata / riser / contremarche / setzstufe



Gradini di riposo

RESTING STEPS
REPOSE PIEDS
RASTSTUFEN

La normativa FINA prevede la possibilità di avere superfici di appoggio (gradini di riposo) situati lungo una o più pareti della vasca ad un minimo di 1,20 m. sotto il livello dell'acqua e con una larghezza variabile fra 10 cm e 15 cm.

Per ragioni di sicurezza è consigliabile che i gradini di riposo abbiano una superficie antiscivolo, siano di un colore a contrasto ed abbiano il bordo arrotondato.

Nel caso di vasche dedicate alla pallanuoto è richiesto che il gradino di riposo sia incassato nella parete.

The FINA standard allows to build supporting structures (resting steps) on one or more walls of the pool at a minimum depth of 1.20 meters below water level, with a width from 10 cm to 15 cm.

For security reasons it is very important that the footrest have a non-slip surface, a contrasting colour from the walls of the pool and rounded edges.

For water polo pools, it is necessary that the footrests be recessed into the walls.

Les normes de la FINA autorisent la réalisation d'une marche pour s'appuyer (repose-pieds) sur une ou plusieurs parois du bassin à 1,20 mètres de profondeur minimum, avec une largeur de 10 cm à 15 cm.

Pour des raisons de sécurité il est très important que les repose-pieds aient une surface antidérapante, de groupe C avec bord arrondi et marquage de sécurité.

En cas de bassins de water-polo, il faut que les repose-pieds soient encastrés dans les parois.

Die FINA-Bestimmungen sehen die Konstruktionsmöglichkeit verschiedener Stützflächen (Raststufen) entlang einer Beckenwand oder mehrerer Beckenwände mindestens 1,20 m unter dem Wasserspiegel und mit einer variablen Breite zwischen 10 cm und 15 cm vor.

Aus Sicherheitsgründen ist es empfehlenswert, dass die Raststufen eine rutschfeste Oberfläche haben, mit einer Kontrastfarbe gekennzeichnet sind und eine abgerundete Kante aufweisen.

Bei für den Wasserball bestimmten Schwimmbecken muss die Raststufe in die Wand eingebaut sein.



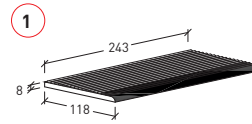
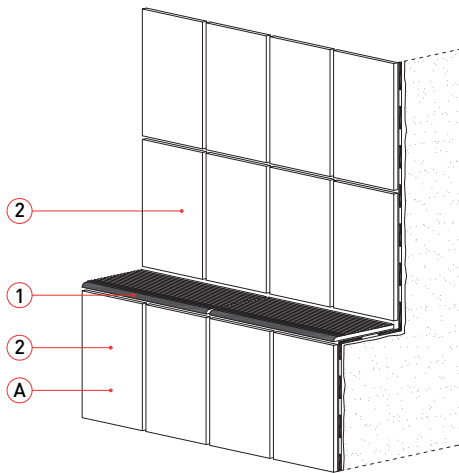

3346 Banda Nera

LANDSCAPE - Rigata

100 Tundra

ELEMENTI - Rigata

010 Talco

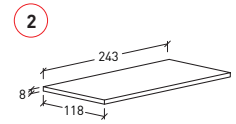

1100

LANDSCAPE - Satin

100 Tundra 200 Bay 202 Ocean
 501 Bahama 700 Lava 701 Artic
 101 Beach

mod. RP 013

A LANDSCAPE - Satin
 interno vasca / pool tank / interieur bassin / becken

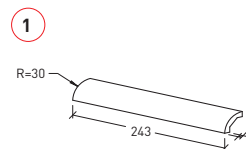
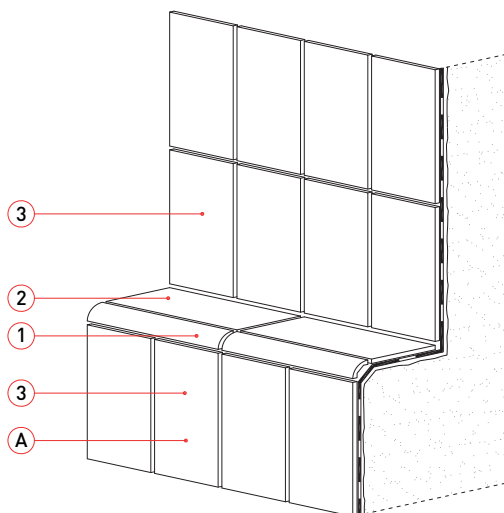

5630

LANDSCAPE - Grip

100 Tundra 202 Ocean 700 Lava

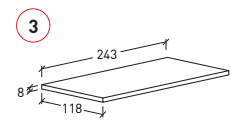

1100

LANDSCAPE - Satin

100 Tundra 200 Bay 202 Ocean
 501 Bahama 700 Lava 701 Artic
 101 Beach

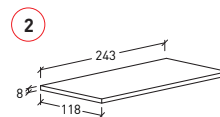

1100

LANDSCAPE - Grip

100 Tundra 200 Bay 202 Ocean
 501 Bahama 700 Lava

mod. RP 008

A LANDSCAPE - Satin
 interno vasca / pool tank / interieur bassin / becken

Muretti

FENCES
MURETS
MAUERN

Muretti, isole, aiuole sono complementi architettonici con funzioni estetiche e pratiche per delimitare spazi con diverse destinazioni d'uso che trovano sempre maggior gradimento nei grandi centri natatori.

Per questi elementi costruttivi è necessario evitare la presenza di spigoli vivi e creare sempre forme arrotondate e/o smussate.

Qualora le superfici orizzontali siano percorse a piedi nudi è necessario prevedere l'uso di materiali con specifica superficie antiscivolo.

Concrete fences, benches and flowerbeds are architectural elements with aesthetic and practical functions to separate spaces that have different uses. These are becoming more and more appreciated in large swimming facilities.

For these elements it is important to eliminate sharp edges by ensuring the use of rounded fittings.

In case the horizontal parts of these fences are treaded upon with bare feet, it is necessary to consider the use of non-slip ceramic tiles to prevent accidents.

Murets, jardiniers et îlots sont des compléments avec des fonctions esthétiques et pratiques de délimitation des espaces qui trouvent de plus en plus place dans les grands centres nautiques.

Pour ces éléments, il faut éliminer les arêtes vives en prévoyant le recours à des formes arrondies.

Au cas où les surfaces horizontales seraient parcourues à pieds nus, il faut également prévoir l'emploi de carreaux spécialement conçues avec fonction antidérapante.

Mauern, Inseln und Beete sind architektonische Ergänzungen mit ästhetischen und praktischen Funktionen, die der Begrenzung der Bereiche mit unterschiedlichen Verwendungszwecken dienen und die in den großen Schwimmbädern immer mehr Zuspruch finden.

An diesen Bauteilen müssen scharfe Kanten vermieden und stets gerundete und/oder abgekantete Formen verwendet werden.

Werden die waagerechten Flächen barfuß betreten, sind Materialien mit einer spezifischen rutschfesten Oberfläche zu verwenden.



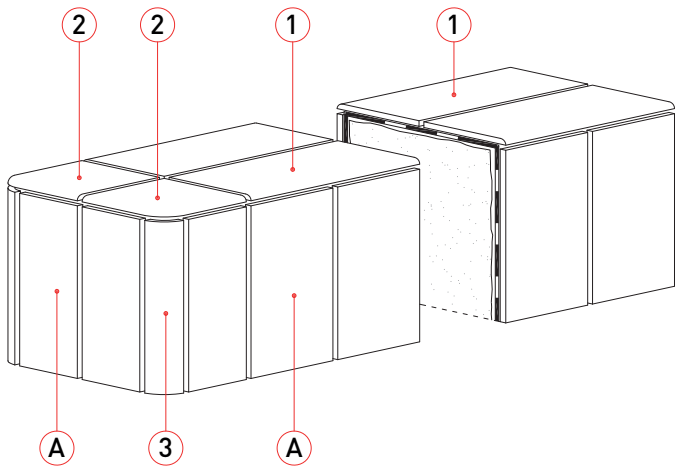

mod. MU 25.0

A LANDSCAPE - Satin_rivestimento / wall tiling / revetement / wandfliesen

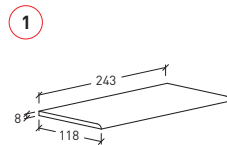

1106

LANDSCAPE - Satin



ELEMENTI - Matt

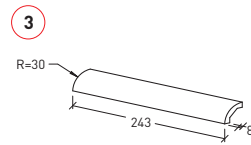
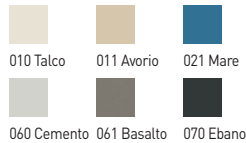

5630

LANDSCAPE - Satin

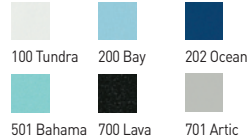

LANDSCAPE - Grip



ELEMENTI - Matt

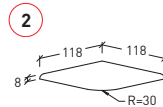

1109

LANDSCAPE - Satin



LANDSCAPE - Grip

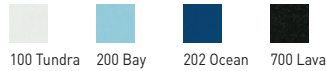

ELEMENTI - Matt

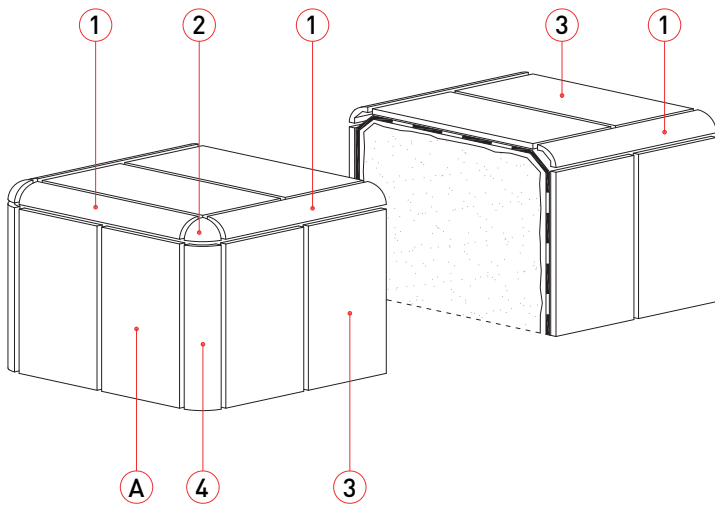
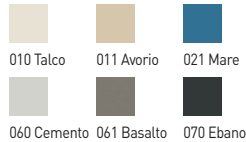

mod. MU 25.4

A LANDSCAPE - Satin_rivestimento / wall tiling / revetement / wandfliesen

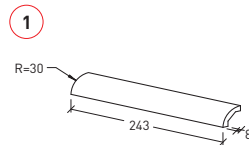

5630

LANDSCAPE - Grip

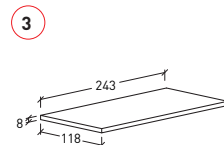

1100

LANDSCAPE - Grip

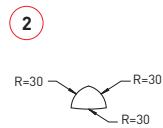
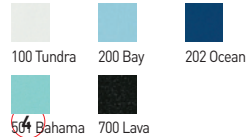

5607

LANDSCAPE - Grip

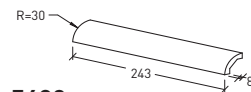

5630

LANDSCAPE - Satin

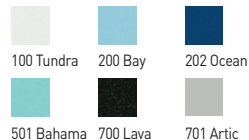

Angoli e spigoli

IN CORNERS AND OUT CORNERS
 ANGLES SORTANTS ET RENTRANTS
 ECKEN UND KANTEN

Nelle piscine, impianti natatori e nei locali accessori è opportuno, se non addirittura necessario, che ogni elemento architettonico abbia sagome e forme sempre arrotondate.

Questo consente di prevenire possibili incidenti dovuti a spigoli vivi e di facilitare le operazioni di pulizia e disinfezione nel caso di angoli.

Pools, swimming facilities and adjacent areas such as showers and locker rooms usually require the use of rounded profiles to avoid accidents due to sharp edges in case of out-corners and simplify cleaning and disinfection in case of in-corners.

Les piscines, les installations de natation et les locaux accessoires exigent le recours à des formes et des profils arrondis, ce qui permet d'éviter tout accident imputable aux arêtes vives et de simplifier le nettoyage et la désinfection de celles-ci.

In den Schwimmbädern, den Schwimmanlagen und den Nebenräumen ist es angemessen, wenn nicht sogar notwendig, dass ein jedes architektonisches Element stets abgerundete Profile und Formen hat.

Das ermöglicht die Vermeidungen von Unfällen, die durch scharfe Kanten verursacht werden, und erleichtert die Reinigung und Desinfektion der Ecken.

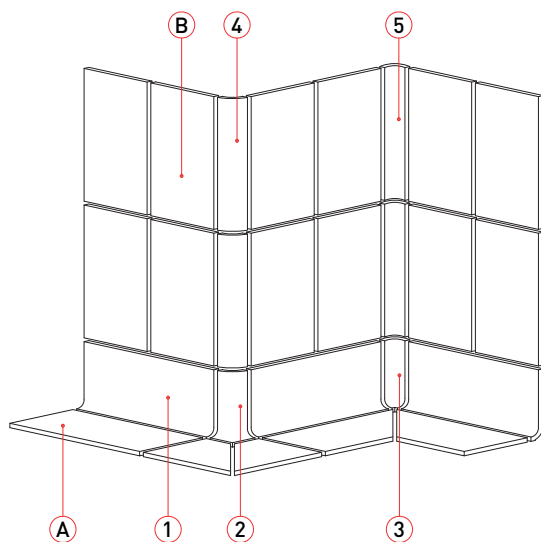

mod. FI 023

- A ELEMENTI - Matt/Pinhead_pavimento / floor / carrelage de sol / bodenfliesen
- B LANDSCAPE - Satin_rivestimento / wall tiling / revetement / wandfliesen

1

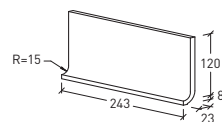

4200

LANDSCAPE - Satin



100 Tundra

2

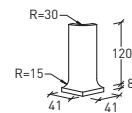

4227

3

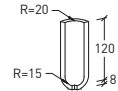

4228

4

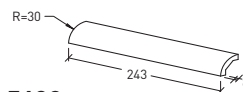

5630

LANDSCAPE - Satin



100 Tundra



200 Bay



202 Ocean



501 Bahama



700 Lava



701 Artic

5

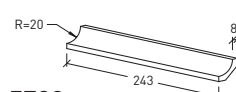

5730

angoli e spigoli / in corners and out corners / angles sortants et rentrants / kanten und ecken

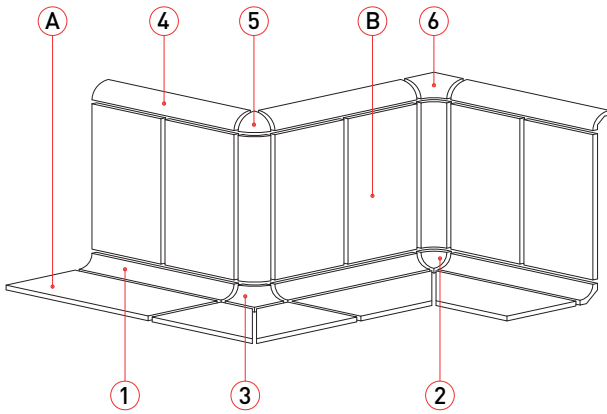

mod. FI 021

- A ELEMENTI - Matt/Pinhead_pavimento / floor / carrelage de sol / bodenfliesen
- B LANDSCAPE - Satin_rivestimento / wall tiling / revetement / wandfliesen

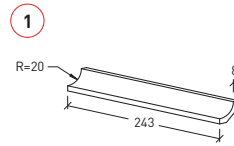

5730

LANDSCAPE - Satin

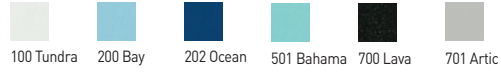

ELEMENTI - Matt

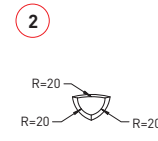

5603

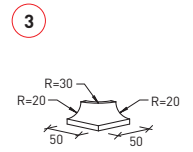

5604

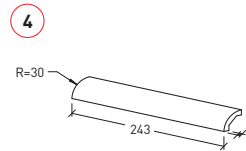

5630

LANDSCAPE - Satin

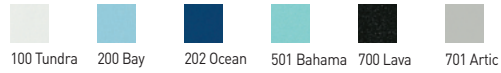

ELEMENTI - Matt

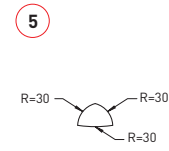

5607

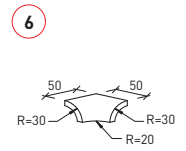

5608

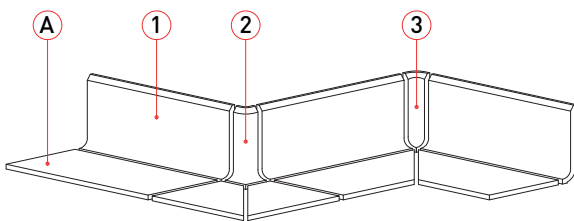

mod. FI 001

- A ELEMENTI - Matt/Pinhead_pavimento / floor / carrelage de sol / bodenfliesen

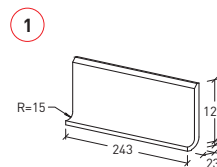

4100

LANDSCAPE - Satin



ELEMENTI - Matt

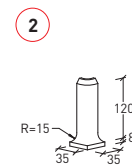
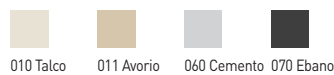

4127

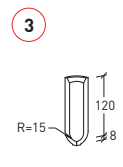

4128

Vasche lavapiedi

FEET WASHERS
PEDILUVES
DURCHSCHREITBECKEN

I regolamenti sanitari e di igiene delle piscine pubbliche obbligano l'accesso alle vasche unicamente attraverso vaschette lava piedi che hanno in genere profondità variabile dai 10 ai 20 cm.

Queste possono essere di tipo tradizionale, cioè incassate nel pavimento, oppure a conca con accesso facilitato per permettere l'attraversamento anche ai disabili motori muniti di carrozzine.

Il livello dell'acqua è generalmente mantenuto costante lasciando traboccare l'eccesso in una canaletta o in una apposita piletta.

Il fondo di queste vasche deve essere realizzato con materiale antiscivolo di gruppo C a piedi nudi.

Sanitary measures oblige access to public pools through feet washers to clean and disinfect feet of users. The depth of feet washers is normally between 10 and 20 cm.

These feet washers may be conventional, i.e. embedded in the floor, or as a curved hollow to enable access to users on wheelchairs too.

The water level is normally kept by a system of overflow that leave excess water to flow in a suitable channel or water outlet.

The bottom of these feet washer has to be done with Group C barefoot non-slip tiles.

Les mesures sanitaires prévoient que l'accès aux bassins des piscines publiques passe obligatoirement par des pédiluves afin de nettoyer et désinfecter les pieds. La profondeur des pédiluves est normalement entre 10 cm et 20 cm.

Ces pédiluves peuvent être de type traditionnel, à savoir encastrés dans la plage, ou à pentes inversées normalisées à 5% maximales avec accès facilité pour les personnes en fauteuil roulant.

Le niveau de l'eau est normalement gardé par un système de trop-plein avec caniveau ou bonde spécifique.

Le fond des pédiluves doit être réalisé avec des carreaux antidérapants pieds nus de groupe C.

Die sanitären und hygienischen Bestimmungen für öffentliche Schwimmbäder machen einen ausschließlichen Zugang zu den Schwimmbecken über Durchschreitbecken mit einer allgemeinen Tiefe zwischen 10 und 20 cm obligatorisch.

Diese können traditioneller Art, d.h. in den Fußboden eingebaut, oder muldenförmig sein, um somit auch den Zugang für motorisch behinderte Personen im Rollstuhl zu erleichtern.

Der Wasserspiegel wird im Allgemeinen konstant gehalten und das überschüssige Wasser läuft in eine Rinne oder in einen eigens dazu vorgesehenen Beckenauslauf ab. Der Boden dieser Becken muss aus rutschfestem Material der Gruppe C bei barfüßigem Betreten sein.



vasche lavapiedi / foot washers / pédiluves / durchschreitbecken

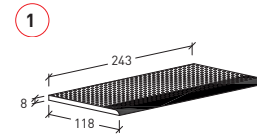
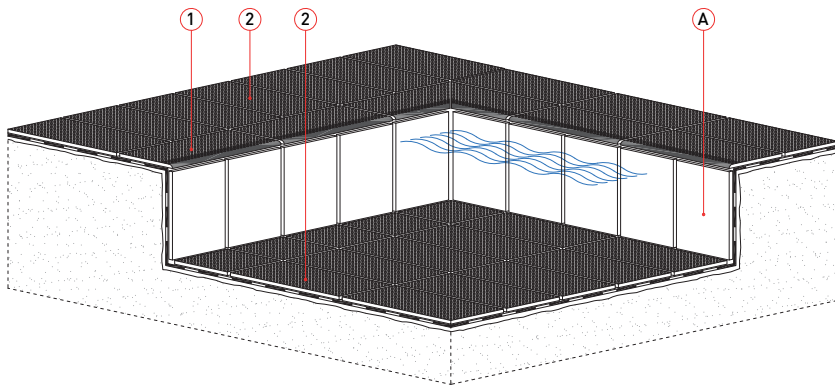

3356 Banda Nera

ELEMENTI - Pinhead

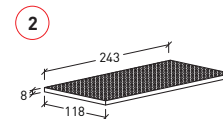

1100

ELEMENTI - Pinhead

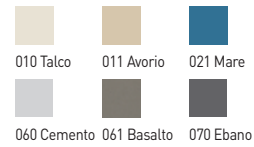

mod. PE 005

A LANDSCAPE - Satin / ELEMENTI - Matt_rivestimento / wall tiling / revetement / wandfliesen

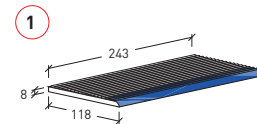
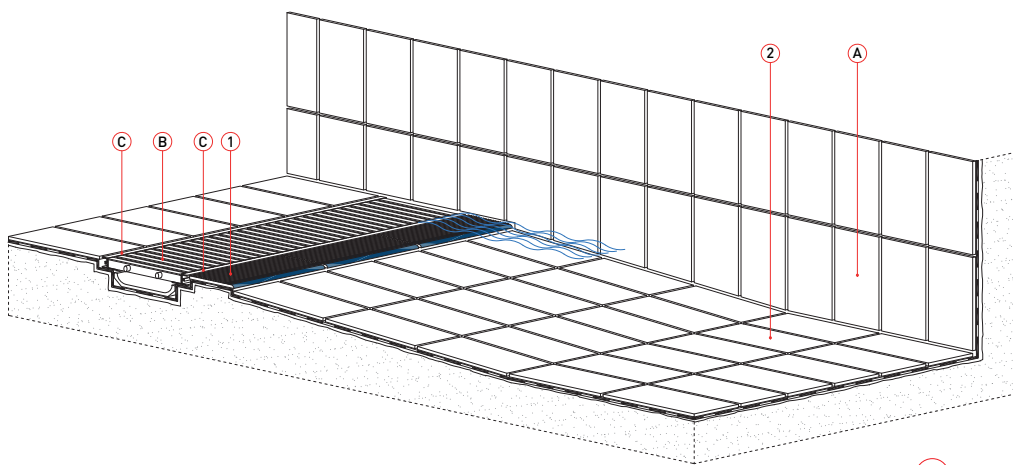

3346 Banda Blu

LANDSCAPE - Rigata

ELEMENTI - Rigata

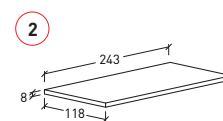

1100

LANDSCAPE - Grip



mod. PE 006

A LANDSCAPE - Satin_rivestimento / wall tiling / revetement / wandfliesen

B PADANA GRID_griglia in pvc / grating in pvc / grille en pvc / pvc rost

C PADANA GRID_angolare in pvc / pvc grating support / corniere en pvc / pvc rost traeger

Panche e sedute

SITTING AND LAYING BENCHES
BANQUETTES
BÄNKE UND LIEGEN

La presenza di vasche ricreative o ludiche è sempre più frequente negli impianti natatori per offrire momenti di svago e relax agli utenti.

Per consentire di godere appieno degli effetti rilassanti e tonificanti dell'acqua queste vasche vengono poi corredate con diversi tipi di getti massaggianti e da sdrai e/o sedute immerse nell'acqua.

Diventa pertanto preferibile ed opportuno che questi elementi costruttivi abbiano forme ergonomiche che favoriscano il confort e che assicurino finiture arrotondate per prevenire gli infortuni.

Recreational and fun pools are becoming more popular in swimming facilities to provide relaxation and leisure to users.

To help take full advantage of the toning and relaxing effects of water, these pools are equipped with various water jets, underwater deckchairs and seats.

It is therefore advisable that the structures of these elements be, wherever possible, ergonomic in order to ensure the comfort of bathers and with rounded edges to prevent accidents.

Les bassins récréatifs ou ludiques sont de plus en plus nombreux dans les installations de natation pour offrir des moments de détente et relaxation aux usagers.

Pour permettre de bénéficier pleinement des effets tonifiants et relaxants de l'eau, ces bassins sont équipés de différentes buses d'hydro-massage et/ou de banquettes plongées dans l'eau.

Il est donc recommandable que les structures de ces éléments soient, dans la mesure du possible, ergonomiques pour le confort des baigneurs et avec des arêtes arrondies pour prévenir les accidents.

Man findet immer häufiger Spiel- und Freizeitbecken in den Schwimmanlagen, die den Badegästen Momente der Erholung und Entspannung ermöglichen.

Damit die entspannende und belebende Wirkung des Wassers voll ausgeschöpft werden kann, sind diese Becken mit verschiedenen Arten von Schwallstrahlen und mit Liegen und/oder Sitzgelegenheiten unter Wasser ausgestattet.

Diese Bauteile sollten daher möglichst und zweckmäßigerweise ergonomische Formen haben, die den Komfort begünstigen und abgerundete Oberflächenausführungen zur Unfallvermeidung gewährleisten.

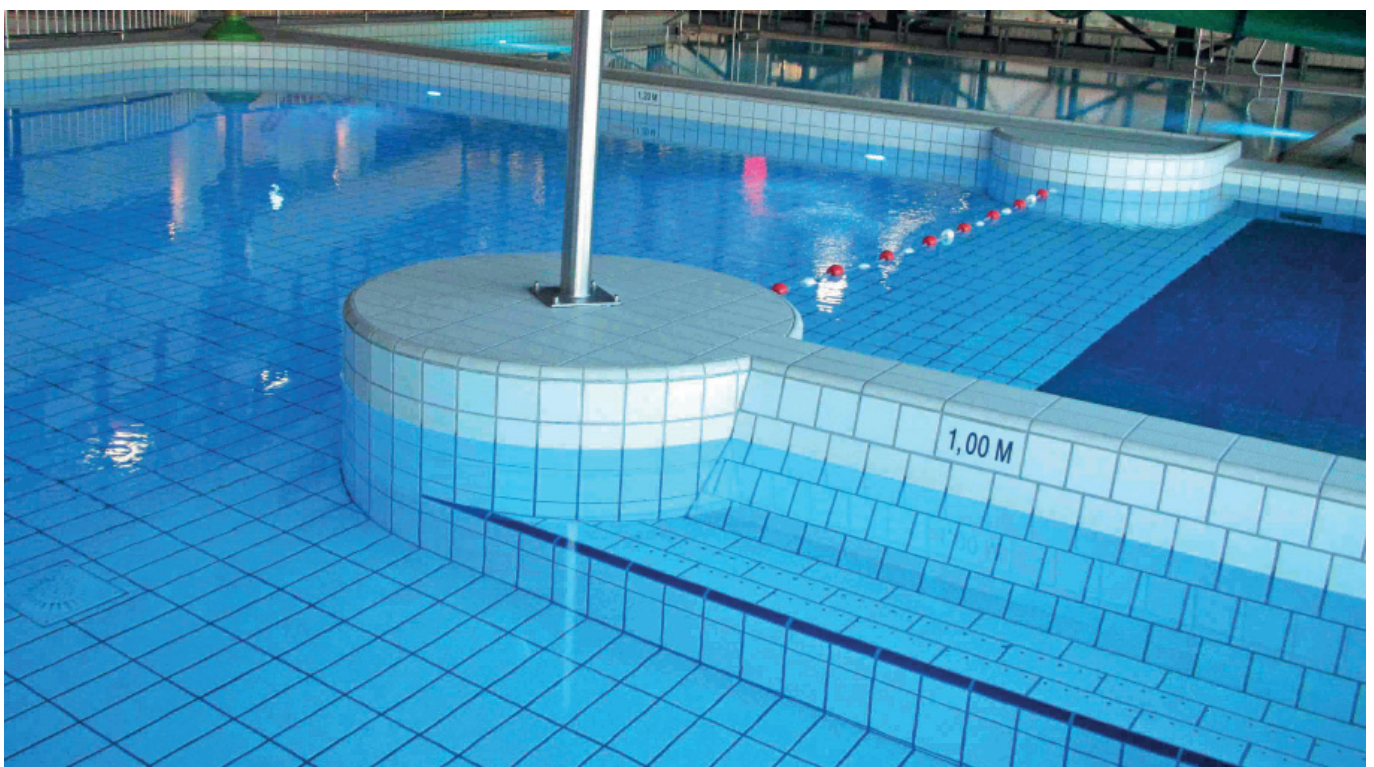



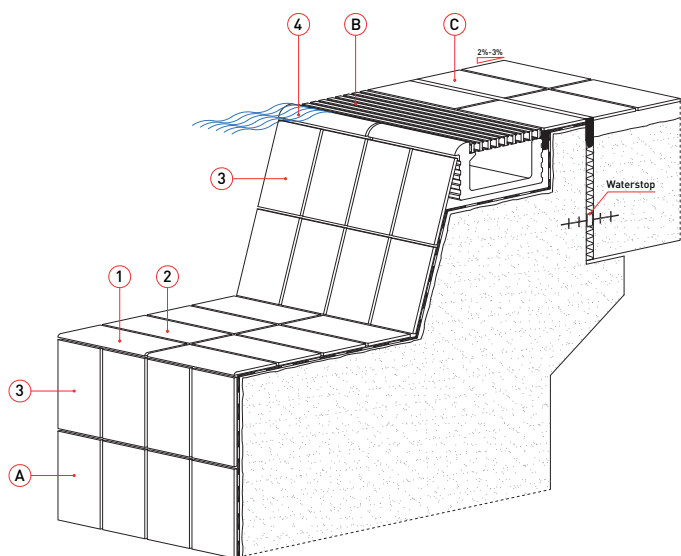

BA 004

- A LANDSCAPE - Satin_interno vasca / pool tank / interieur bassin / becken
- B PADANA GRID_griglia in pvc / grating in pvc / grille en pvc / pvc rost
- C ELEMENTI - Matt/Pinhead_esterno vasca / pool surround / plage / beckenumgang

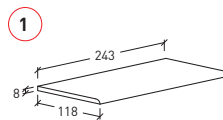

1106

LANDSCAPE - Grip

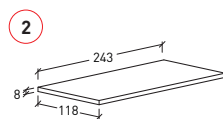
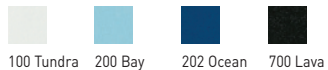

1100

LANDSCAPE - Friction

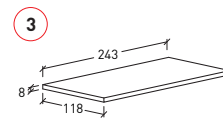
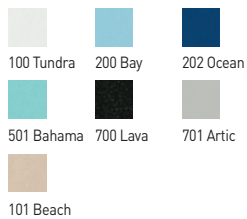

1100

LANDSCAPE - Satin

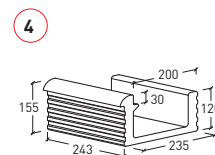
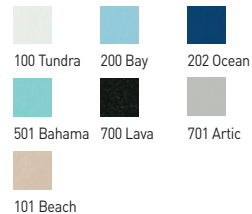

6600

LANDSCAPE - Satin



panche e sedute / sitting and laying benches / banquettes / bänke und liegen

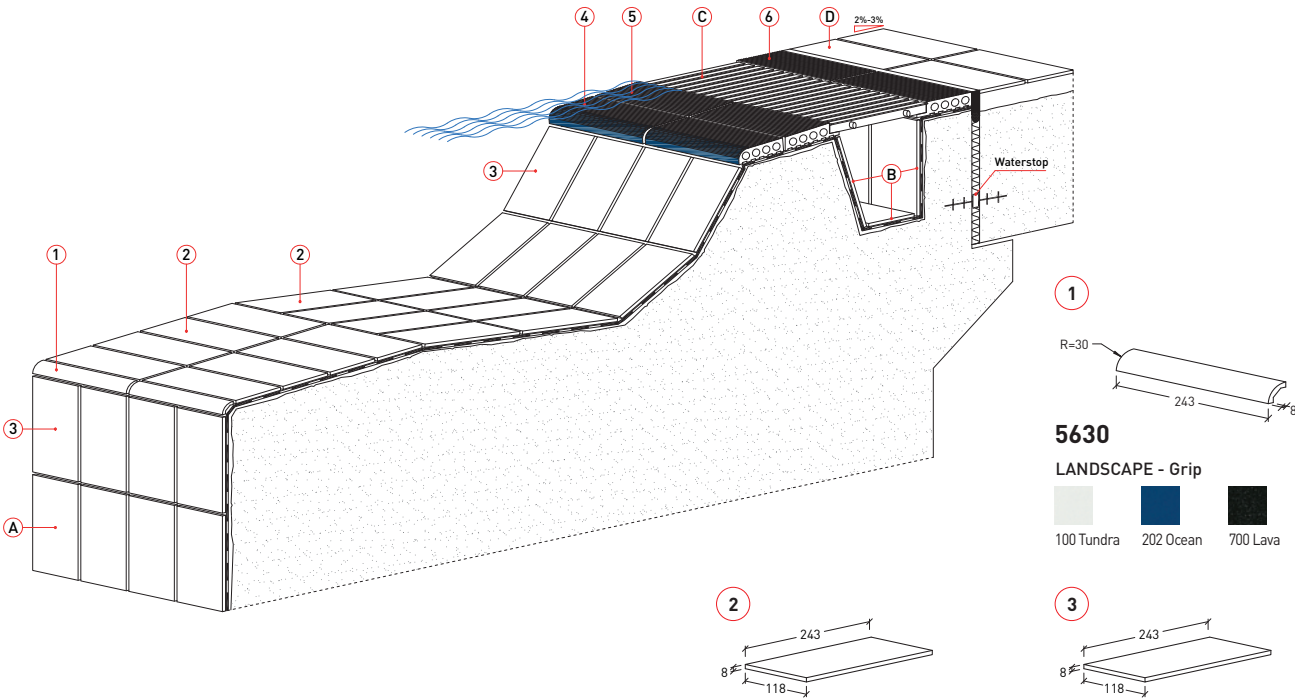

BR 004

- A LANDSCAPE - Satin_interno vasca / pool tank / interieur bassin / becken
- B LANDSCAPE - Satin_canaletta di ricircolo / overflow channel / caniveau eau bassin / rinne
- C PADANA GRID_griglia in pvc / grating in pvc / grille en pvc / pvc rost
- D ELEMENTI - Matt/Pinhead_esterno vasca / pool surround / plage / beckenumgang

5630
LANDSCAPE - Grip

100 Tundra	202 Ocean	700 Lava

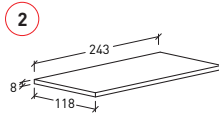

1100
LANDSCAPE - Friction

100 Tundra	200 Bay	202 Ocean
501 Bahama	700 Lava	701 Artic
101 Beach		

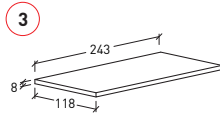

1100
LANDSCAPE - Satin

100 Tundra	200 Bay	202 Ocean
501 Bahama	700 Lava	701 Artic
101 Beach		

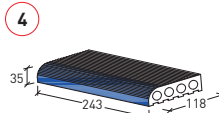

9046 Banda Blu
Trim-Box

P102-0242
Polyfill cilindro / cylinder / cilindre / Zylinder
(4 pcs)*

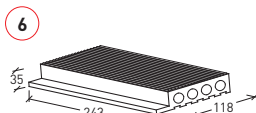

8600
Trim-Box

P102-0242
Polyfill cilindro / cylinder / cilindre / Zylinder
(4 pcs)*

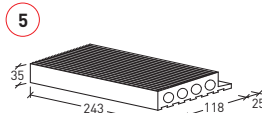

8800
Trim-Box

P102-0242
Polyfill cilindro / cylinder / cilindre / Zylinder
(4 pcs)*

LANDSCAPE - Rigata

100 Tundra
ELEMENTI - Rigata
010 Talco

* Vedi pagina: See page: Voir page: Siehe Seite: 42



WELLNESS & SPA

CERAMICHE PER WELLNESS E SPA

CERAMICS FOR WELLNESS AND SPA

CERAMIQUES POUR WELLNESS ET SPA

KERAMIK FÜR WELLNESS UND SPA

Naturali come l'acqua

AS NATURAL AS WATER
NATURELLES COMME L'EAU
NATÜRLICH WIE DAS WASSER

Le aree wellness, le grandi spa ed i centri benessere sono luoghi progettati per evocare emozioni e stimoli sensoriali; i materiali dei rivestimenti diventano così i mezzi privilegiati ed eletti a creare spazi accoglienti e confortevoli dove l'acqua è protagonista con vigore energetico o rilassante pacatezza.

Casalgrande Padana ha messo a punto una selezione di prodotti in gres porcellanato dalle superfici naturali, dalla tattilità materica e dal cromatismo seducente ad alte prestazioni tecniche per resistere al continuo contatto con l'acqua e l'umidità.

Natura, comfort e benessere, ma anche sicurezza e durata nel tempo. Un solido matrimonio tra tecnologia ed estetica contemporanea che valorizza gli investimenti ed i progetti architettonici del settore wellness.

Wellness centres, large spas and thermal centres are places designed to evoke emotions and stimulate the senses; cladding materials become the privileged elements of choice to create welcoming and comfortable spaces where water is the protagonist, with energising force or relaxing calm.

Casalgrande Padana designed a range of stoneware tiles with natural, highly tactile surfaces with a very appealing colour palette and high technical performance to withstand continuous contact with water and humidity.

Nature, comfort and well being, but also safety and durability over time. That is, a strong combo between technology and contemporary aesthetics to enhance investment and architectural projects in the wellness industry.

Les centres de bien-être, de thalassothérapie et les grands spas sont des lieux conçus pour évoquer des émotions et des stimulations sensorielles ; les matériaux des revêtements deviennent ainsi des moyens privilégiés et prioritaires pour la création d'espaces accueillants et confortables où l'eau est la protagoniste, avec vigueur énergétique ou calme relaxant.

Casalgrande Padana a conçu un éventail de produits en grès cérame aux surfaces naturelles, matériques au touche et au chromatisme séduisant, garantissant des performances techniques élevées pour résister au contact continu avec l'eau et l'humidité.

Nature, confort et bien-être, mais également sécurité et résistance dans le temps. À savoir, une union solide entre technologie et esthétique contemporaine pour valoriser les investissements et les projets architecturaux du secteur du bien-être.

Die Wellnessbereiche, die großen Heilbäder und die Wellnesszentren sind Orte, die mit dem Ziel geplant werden, Gefühle zu erwecken und die Sinne anzuregen; die Materialien der Verkleidungen werden somit zu privilegierten und auserwählten Instrumenten zur Schaffung von einladenden und behaglichen Bereichen, in denen das Wasser mit energischer Kraft oder entspannter Gelassenheit die Hauptrolle spielt.

Casalgrande Padana hat eine Auswahl von Feinsteinzeugprodukten mit matten Oberflächen, materischem Tastempfinden und verführerischen Farbeffekten sowie mit hohen technischen Leistungen erstellt, damit das Produkt dem beständigen Kontakt mit Wasser und Feuchtigkeit standhalten kann.

Natürlichkeit, Komfort und Wohlbefinden, aber auch Sicherheit und langfristige Beständigkeit. Es handelt sich um eine solide Verbindung zwischen der Technologie und der zeitgenössischen Ästhetik, die die Investitionen und die architektonischen Projekte der Wellnessbranche zur Geltung bringt.



Mineral Chrom

PIETRE NATIVE

La serie Mineral Chrom, realizzata in gres fine porcellanato, è frutto di una tecnologia produttiva d'avanguardia in grado di offrire elevate prestazioni ed ampie possibilità compositive.

La texture superficiale è volutamente caratterizzata da lastre con più tonalità cromatiche e da accattivanti effetti tridimensionali in modo che, come in natura, nessuna lastra sia uguale all'altra.

Per consentirne l'impiego in aree asciutte e bagnate oppure per rivestimenti murali, tutti i colori della Serie Mineral Chrom, nei formati 30x30 cm e 30x60 cm, sono disponibili sia con superficie Soft classificata R10-B sia con superficie Naturale classificata R11-B secondo Norma DIN 51097.

Corredata con mosaici, listelli, decori e pezzi speciali di finitura Mineral Chrom diventa idonea per rivestire fondo e pareti di piscine termali, ricreative e private, esterni vasche, solarium, spogliatoi e aree accessorie.

Mineral Chrom è resistente alla flessione, all'usura, all'abrasione, agli attacchi chimici e agli sbalzi termici e pertanto è utilizzabile sia in spazi interni che esterni.

The Mineral Chrom range of fine stoneware tiles is the result of a cutting-edge production technology that provides excellent performance and a wide range of combinations.

The surface texture has been deliberately made of multi-coloured slabs and attractive three-dimensional effects so that no two slabs are identical, as it happens in nature.

In order to have the possibility to properly use Mineral Chrom products in dry and wet areas and for wall applications, all colors sized 30x30 cm and 30x60 cm are available with surface Soft rated R10-B and with surface Naturale rated R11-B according to DIN 51097 Standard.

The range includes mosaics, listellos, decors and fittings and is therefore suitable to tile bottoms and walls of thermal pools, recreational and private pools, pool decks, solariums, locker rooms and adjacent areas.

Mineral Chrom has excellent flexural strength, as well as wear, abrasion, chemical and thermal resistance, so it can be used both indoors and outdoors.

La série Mineral Chrom, réalisée en grès cérame, est le fruit d'une technologie de fabrication de pointe étant en mesure d'offrir des performances élevées et de larges possibilités de composition.

La texture superficielle est délibérément caractérisée par des dalles à plusieurs tons chromatiques et aux effets tridimensionnels captivants de sorte que, tout comme dans la nature, aucune dalle ne soit égale à l'autre.

Pour permettre le bon emploi dans les sols secs et mouillés et/ou pour les habillages muraux, toutes les teintes de la Série Mineral Chrom en format 30x30 cm et 30x60 cm sont disponibles avec finition Soft classée R10-B et finition Naturale classée R11-B selon la norme DIN 51097.

La gamme se complète avec mosaïques, listels, décorations et pièces spéciales qui permettent de réaliser piscines thermales, piscines ludiques et privées, plages de piscine, solariums, vestiaires à l'intérieur et à l'extérieur.

Mineral Chrom est résistant à la flexion, à l'usure, à l'abrasion, aux attaques chimiques et aux chocs thermiques, donc il peut être utilisé aussi bien à l'extérieur qu'à l'intérieur.

Die Serie Mineral Chrom aus Feinsteinzeug ist das Ergebnis einer fortschrittlichen Produktionstechnologie, die hohe Leistungen und umfangreiche Kombinationsmöglichkeiten bietet.

Für die Oberflächentextur wurden bewusst Platten mit mehreren Farbtönen und mit attraktiven dreidimensionalen Wirkungen entwickelt, damit genauso wie in der Natur keine Platte der anderen gleicht.

Alle Farben der Serie Mineral Chrom, in den Formaten 30x30 cm und 30x60 cm, sind in der Oberfläche Soft (R10-B) und Naturale (R11-B) erhaltbar. Dies ermöglicht die Verwendung dieser Platten in Trocken- und Nassbereiche oder als Wandbekleidung.

Ausgestattet mit Mosaiken, Listellos, Dekoren und Formstücken, die Serie Mineral Chrom ist sowohl für die Boden- und Wandverlegung von Thermalbädern, Freizeit- und Privatschwimmbädern, als auch für Freibäder, Sonnenbereiche, Umkleide- und Nebenräume geeignet.

Mineral Chrom ist biegefest und beständig gegen Verschleiß, Abrieb, Chemikalien, Temperaturschwankungen und kann somit sowohl in Innen- wie auch Außenbereichen eingesetzt werden.

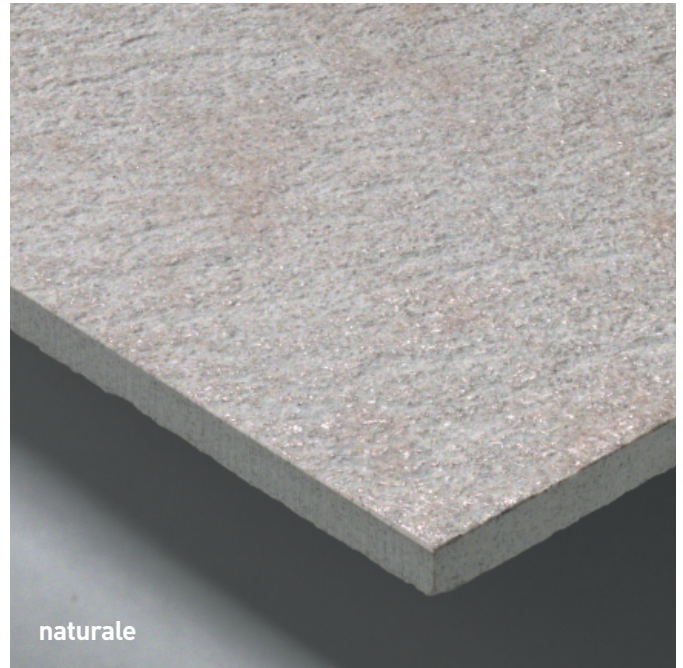
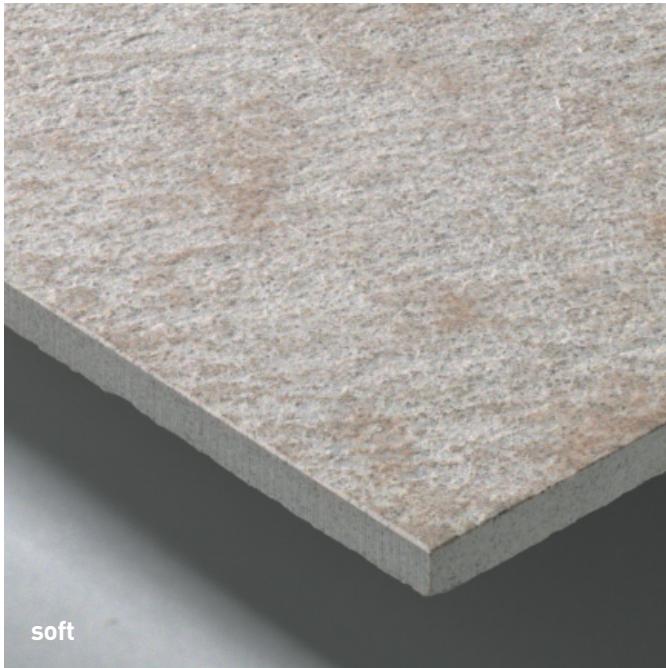

● Soft ^[1]

DIN 51097 B	XP P 05-010 PN 18	
DIN 51130 R 10	XP P 05-010 PC 10	

Formati Sizes
Formats Formate

Superfici Surfaces
Surfaces Oberflächen



cm 30x30
11³/₄"x11³/₄"



mm 9



cm 30x60
11³/₄"x23⁵/₈"



mm 9

● Naturale ^[2]

DIN 51097 B	XP P 05-010 PN 18	
DIN 51130 R 11	XP P 05-010 PC 20	

Rettificate in un unico calibro Rectified version in a single caliber Rectifiés en un unique calibre Boden Sie in einem einzigen Kaliber

^[1] A pavimento: zone asciutte Floor: dry zones Revêtement de sol : zones sèches Boden: trokenzonen

^[2] A pavimento: zone asciutte e zone umide Floor: dry zones and wet zones Revêtement de sol : zones sèches et zones humides
Boden: trokenzonen und feuchenzonen

Caratteristiche tecniche a pagina: Technical features on page: Caractéristiques techniques à la page: Technische Eigenschaften auf Seite: 235

MINERAL CHROM

Mineral White



Mineral Grey



Mineral Black

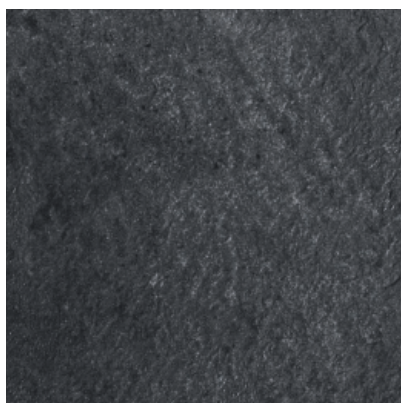

Mineral Beige



Mineral Gold



Mineral Brown



Accentuata
Heavy mixed
Fortement
Starkes

Vedi pagina: See page: Voir page: Siehe Seite: **237**



MINERAL CHROM

MOSAICI*

Mosaico Mineral 3x3 cm



30x30 cm 11^{3/4}"x11^{3/4}"
3x3 cm 1^{1/8}"x1^{1/8}"

Standard su rete
Standard on net
Standard sur trame
Standard auf Netz

Su richiesta con rete davanti
On demand with net on front side
Sur demande avec trame sulla belle face
Auf Anfrage mit Netz auf Vorderseite

Mosaico Mineral 6x6 cm



30x30 cm 11^{3/4}"x11^{3/4}"
6x6 cm 2^{3/8}"x2^{3/8}"

Standard su rete
Standard on net
Standard sur trame
Standard auf Netz

Su richiesta con rete davanti
On demand with net on front side
Sur demande avec trame sulla belle face
Auf Anfrage mit Netz auf Vorderseite

Vedi dettagli a pagina: See details on page: Voir détails à la page: Siehe Details auf Seite: **238**

DECORI**

Composizione A



30x60 cm 11^{3/4}"x23^{5/8}"
Su rete On net Sur trame Auf Netz

GRIGLIE CERAMICHE***

Art. 9842



PIASTRELLE NUMERATE*

Art. D400

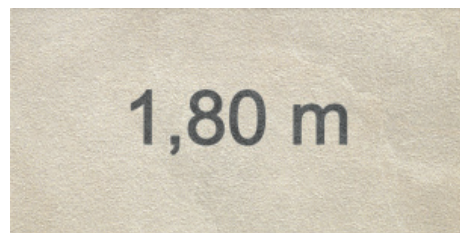

* Disponibile in tutti i colori della serie, superficie Naturale e Soft Available in all the colours of the series, Naturale and Soft surface Disponible dans toutes les couleurs de la série, surface Naturale et Soft Verfügbar in allen Farben, Naturale und Soft Oberfläche

** Disponibile in tutti i colori della serie su superficie Soft Available in all the Soft colours Disponible dans toutes les couleurs pour la surface Soft Verfügbar in allen Farben der Serie, Soft Oberfläche

*** Disponibile in tutti i colori della serie su superficie Naturale Available in all the Naturale colours Disponible dans toutes les couleurs pour la surface Naturale Verfügbar in allen Farben der Serie, Naturale Oberfläche

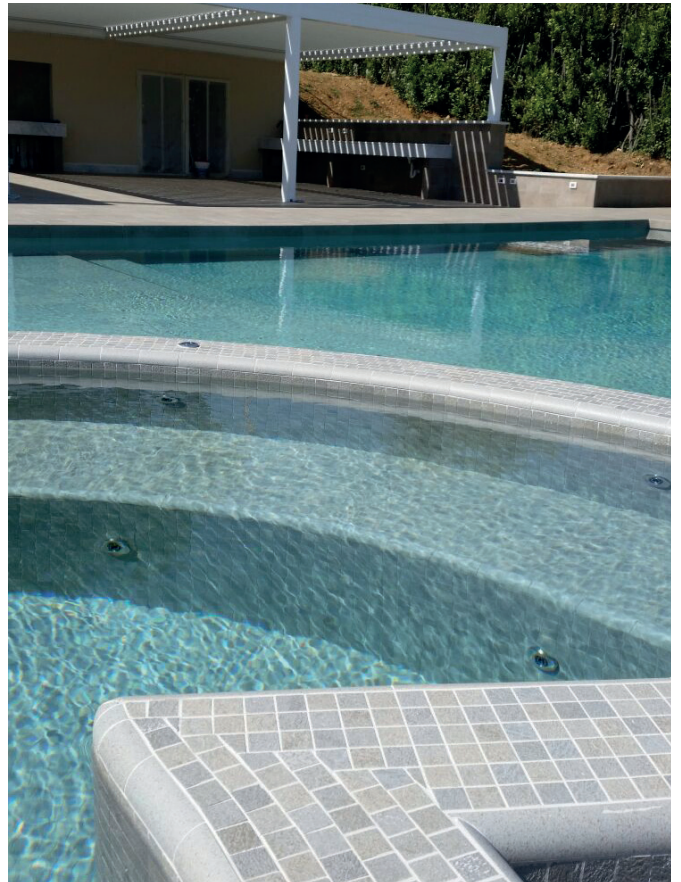
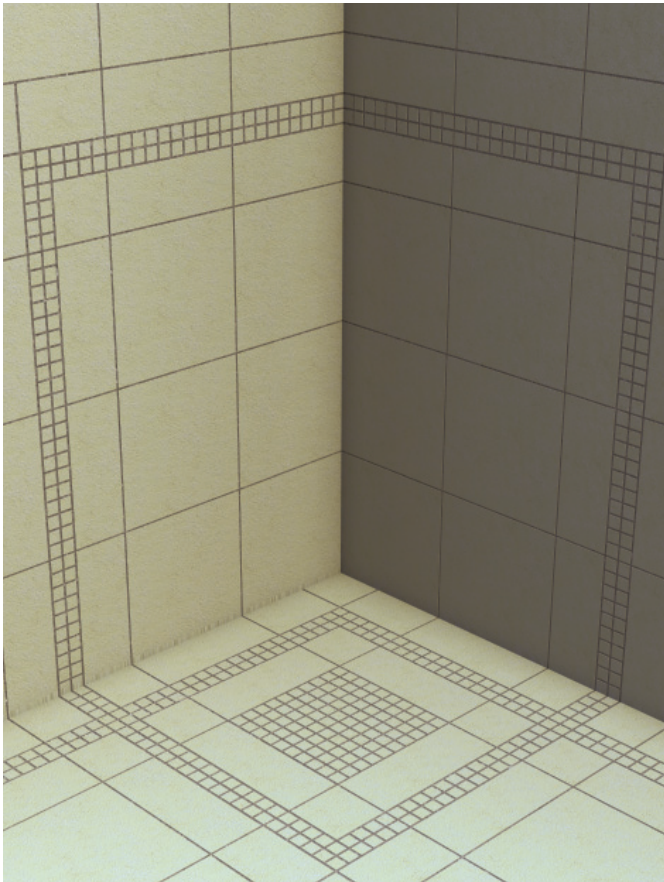

MINERAL CHROM

GRADINI E TERMINALI GRADINO STEP TREADS MARCHES ET NEZ DE MARCHE STUFEN UND TREPPENPLATTEN

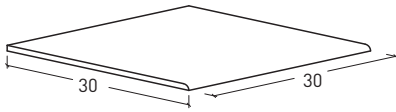

Gradino B.C. 30x30 senza righe

12 pc/box 1,8 kg/pc

MINERAL CHROM - Naturale

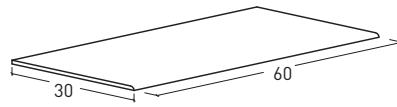

Gradino B.C. 30x60 senza righe

6 pc/box 3,89 kg/pc

MINERAL CHROM - Naturale

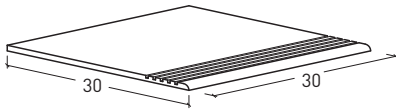

Gradino B.C. 30x30 con righe

12 pc/box 1,8 kg/pc

MINERAL CHROM - Naturale

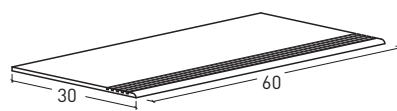

Gradino B.C. 30x60 con righe

6 pc/box 3,89 kg/pc

MINERAL CHROM - Naturale

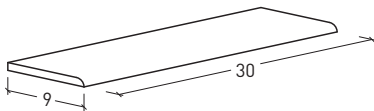

Terminale Gradino B.C. 9x30

28 pc/box 0,5 kg/pc

MINERAL CHROM - Naturale

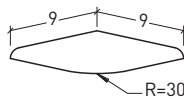

9900 Angolo Terminale Gradino B.C. 9x9

10 pc/box 0,2 kg/pc

MINERAL CHROM - Naturale / Soft



BATTISCOPI SKIRTING BORD ARRONDI SOCKEL

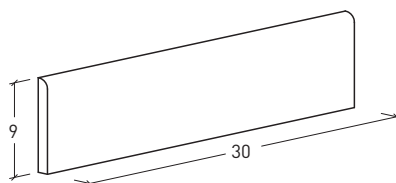

BATTISCOPI B.C. 9x30

28 pc/box 0,5 kg/pc

MINERAL CHROM - Soft



PREZZI SPECIALI SUPERFICIE RIGATA (R11-C) FITTINGS SURFACE RIGATA (R11-C)
PIÈCES FINITION RIGATA (R11-C) (PC20-PN24) FORMSTÜCKE OBERFLÄCHE RIGATA (R11-C)



9870

12 pc/box 1,8 kg/pc

MINERAL CHROM - Naturale



9876

12 pc/box 1,8 kg/pc

MINERAL CHROM - Naturale



SGUSCIE E COPRI SPIGOLI COVES AND QUARTER ROUNDS GORGES ET QUARTS DE ROND HOHLKEHLEN UND RADIALLEISTEN

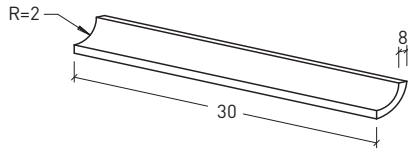

9830

48 pc/box 0,2 kg/pc

MINERAL CHROM

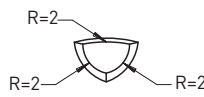

9833

10 pc/box 0,05 kg/pc

MINERAL CHROM

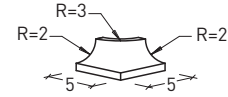

9834

10 pc/box 0,05 kg/pc

MINERAL CHROM

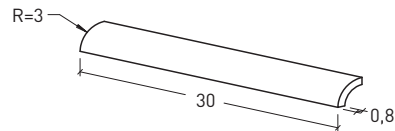

9835

48 pc/box 0,2 kg/pc

MINERAL CHROM

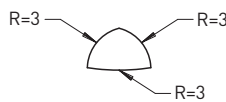

9837

10 pc/box 0,05 kg/pc

MINERAL CHROM

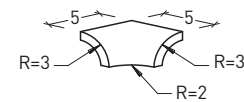

9838

10 pc/box 0,05 kg/pc

MINERAL CHROM



MINERAL CHROM

BORDO FINLANDESE BORDER FINLAND TÊTE DE BASSIN FINLANDAISE BECKENKOPF FINNLAND

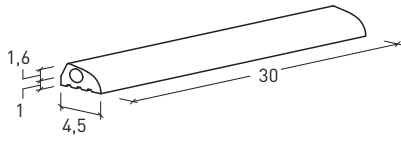

9840

Trim-Box 24 pc/box 0,8 kg/pc

MINERAL CHROM



9870

12 pc/box 1,8 kg/pc

MINERAL CHROM - Naturale



9876

12 pc/box 1,8 kg/pc

MINERAL CHROM - Naturale

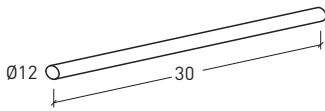

P 214-0296

Polyfill profilo / profile / profil / Profil*

* Vedi pagina: See page: Voir page: Siehe Seite: 42

BORDO WIESBADEN A PAVIMENTO BORDER WIESBADEN HIGH-LEVEL TÊTE DE BASSIN WIESBADEN SURFLOT BECKENKOPF WIESBADEN HOCHLIEGEND

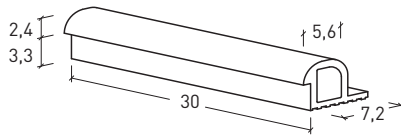

9860

Trim-Box 8 pc/box 0,96 kg/pc

MINERAL CHROM

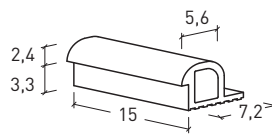

9862

Trim-Box 16 pc/box 0,48 kg/pc

MINERAL CHROM

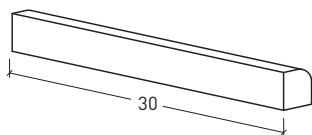

P 310-0296

Polyfill profilo / profile / profil / Profil*

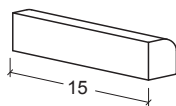

P 311-0147

Polyfill profilo / profile / profil / Profil*

* Vedi pagina: See page: Voir page: Siehe Seite: 42

SUPPORTO BETONBUILD CEMENTITIUS SUPPORT BETONBUILD SUPPORT EN BETON BETONBUILD TRÄGERELEMENT BETONBUILD

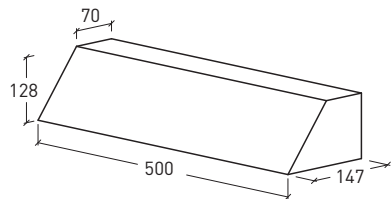

6415

Betonbuild 16,00 kg/pc 2 pc/ml

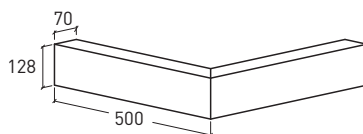

6417

Betonbuild 2 pc 45° 32,00 kg/pc

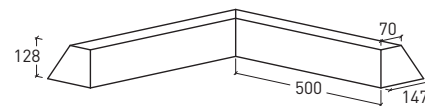

6418

Betonbuild 2 pc 45° 32,00 kg/pc

BORDO WIESBADEN A PARETE BORDER WIESBADEN LOW-LEVEL TÊTE DE BASSIN WIESBADEN EN PAROI BECKENKOPF WIESBADEN TIEFLIEGEND

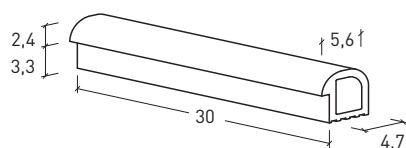

9850

8 pc/box 0,8 kg/pc

MINERAL CHROM

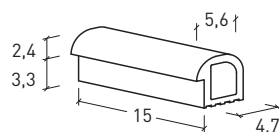

9852

16 pc/box 0,4 kg/pc

MINERAL CHROM

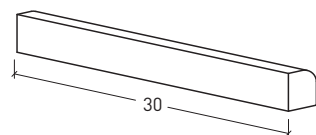

P 310-0296

Polyfill profilo / profile / profil / Profil*

* Vedi pagina: See page: Voir page: Siehe Seite: 42

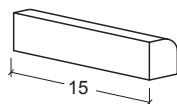

P 311-0147

Polyfill profilo / profile / profil / Profil*

SUPPORTO BETONBUILD CEMENTITIUS SUPPORT BETONBUILD SUPPORT EN BETON BETONBUILD TRÄGERELEMENT BETONBUILD

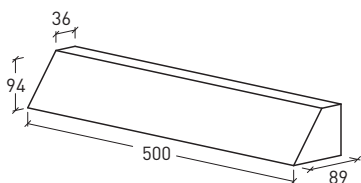

6315

Betonbuild 12,00 kg/pc 2 pc/ml

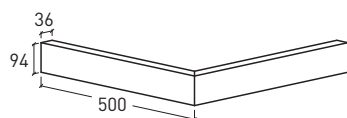

6317

Betonbuild 2 pc 45° 24,00 kg/pc

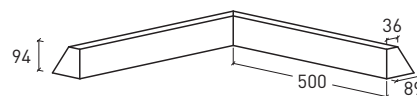

6318

Betonbuild 2 pc 45° 24,00 kg/pc

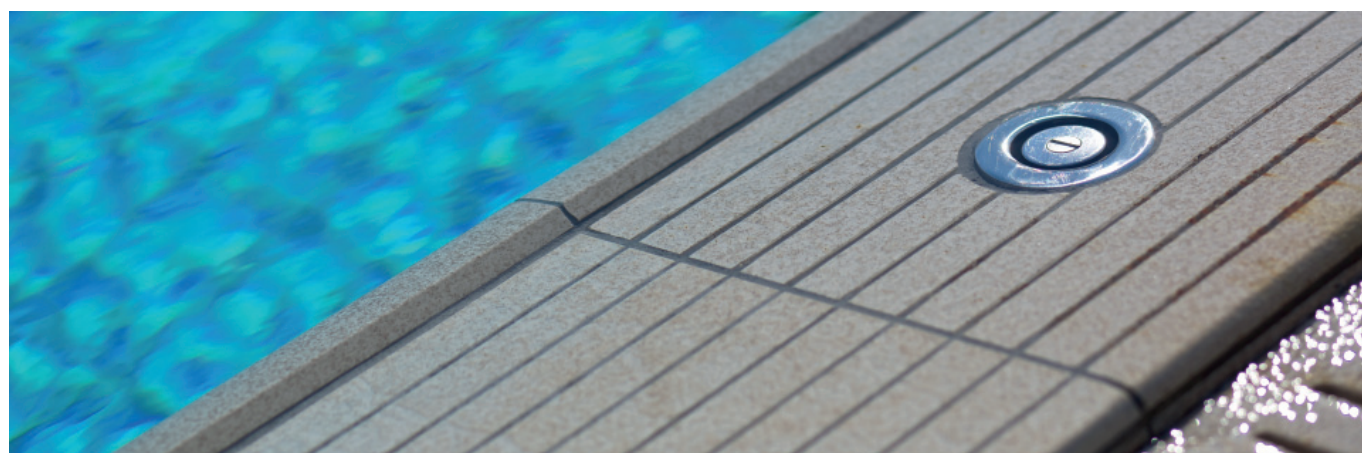

MINERAL CHROM

BORDO VASCA SKIMMER SKIMMER POOL BORDER TÊTE DE BASSIN SKIMMER BECKENKOPF SKIMMER

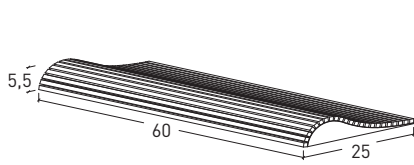

9660 - Pool Wave

1 pc/box 10,0 kg/pc

MINERAL CHROM - Naturale

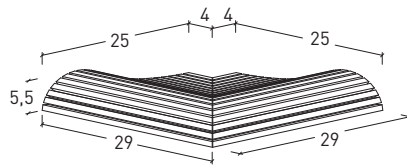

9667 - Pool Wave

2 pc 45° 1+1 pc/box 9,8 kg/pc

MINERAL CHROM - Naturale

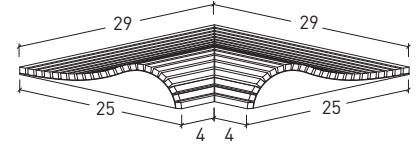

9668 - Pool Wave

2 pc 45° 1+1 pc/box 9,8 kg/pc

MINERAL CHROM - Naturale



GRIGLIE IN CERAMICA PARALLELE PARALLEL CERAMIC GRATINGS GRILLES CÉRAMIQUES PARALLELES PARALLELE ROSTE AUS KERAMIK

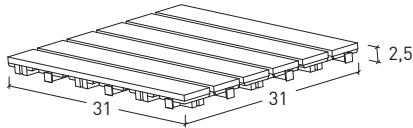

9842 ⁽¹⁾

6 pc/box 2,3 kg/pc

MINERAL CHROM - Naturale

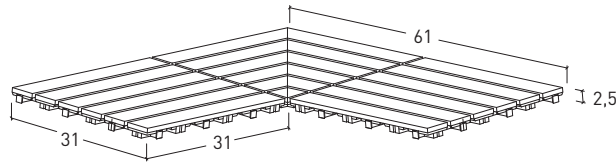

9843 ⁽¹⁾

2 pc 45° 2+2 pc/box 7,9 kg/pc

MINERAL CHROM - Naturale



⁽¹⁾ Idoneità e geometria della griglia da verificare con i professionisti incaricati della progettazione della piscina e dei relativi impianti. Fuga tra griglia e supporto circa 7 mm. Fuga tra ciascun elemento posato circa 3 mm Adequacy and geometry of the grating to be approved by the specialists in charge of the designing of the pool and of the related equipment. Joint between grating and screed approx. 7 mm. Joint between each element laid approx 3 mm Adéquation et géométrie de la grille à bien vérifier par les responsables de la conception de la piscine et des installations associées. Joint entre grille et support d'environ 7 mm. Joint entre chaque élément posé environ 3 mm Eignung und Geometrie des Gitters sind mit den Fachleuten zu überprüfen, die für die Gestaltung des Pools und seiner Systeme verantwortlich sind. Fuge zwischen Gitter und Stütze ca. 7 mm. Fuge zwischen jedem verlegten Element ca. 3 mm

SUPPORTI GRIGLIA GRATING SUPPORTS SUPPORT DE GRILLE ROSTAUFLAGER

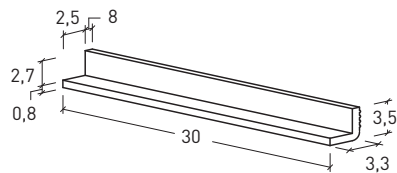

9845

24 pc/box 0,25 kg/pc

MINERAL CHROM

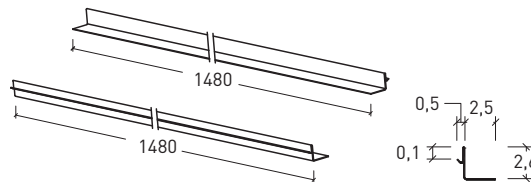

SL25 - IR16*

Supporto griglia in acciaio inox
Stainless steel grating support
Support de grille inox
Rostträger aus Edelstahl

* Articolo realizzato con acciaio inox AISI 316L-BA - EN 1.4404 (Lucido)
Item made with stainless steel AISI 316L-BA - EN 1.4404 (Polished)
Référence fabriquée en acier inox AISI 316L-BA - EN 1.4404 (Poli)
Artikel aus Edelstahl AISI 316L-BA - EN 1.4404 (Glanzend)

PIASTRELLE DI INDICAZIONE MARKING TILES CARREAUX NUMEROTES ANZEIGEFLESSEN

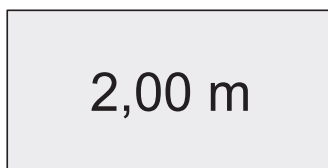
**D400**

Formato 30x60. Carattere Arial Narrow (altezza 7 cm - spessore 7mm)
 Size 30x60. Font Arian Narrow (height 7 cm - width 7 mm)
 Format 30x60. Caractère Arial Narrow (hauteur 7 cm - largeur 7 mm)
 Format 30x60. Schrifttyp Arial Narrow (Schriftöhe 7 cm - Schriftdicke 7 mm)

MINERAL CHROM - Naturale/Soft

Mineral White Mineral Grey Mineral Black



Mineral Beige Mineral Gold Mineral Brown

CANALETTA CERAMICA LINEARE CP007 ASSEMBLATA SU RETE LINEAR CERAMIC CHANNEL CP007 ASSEMBLED ON MESH
 CANIVEAU CERAMIQUE LINEAIRE CP007 ASSEMBLE SUR TREILLIS LINEARKERAMISCHE RINNE CP007 AUF NETS GEKLEBT

Vedi pagina: See page: Voir page: Siehe Seite: **213**

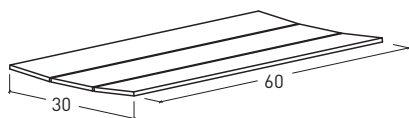
**9795***

Padana-Deck 6 pc/box 10,0 kg/pc

MINERAL CHROM - Naturale

Mineral White Mineral Grey Mineral Black

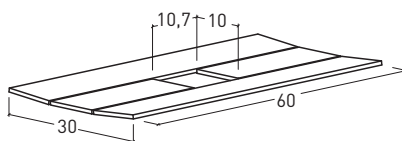

Mineral Beige Mineral Gold Mineral Brown

**9796***

Padana-Deck 6 pc/box 9,8 kg/pc

MINERAL CHROM - Naturale

Mineral White Mineral Grey Mineral Black

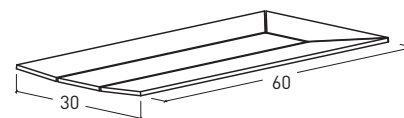

Mineral Beige Mineral Gold Mineral Brown

**9797***

Padana-Deck 6 pc/box 9,8 kg/pc

MINERAL CHROM - Naturale

Mineral White Mineral Grey Mineral Black



Mineral Beige Mineral Gold Mineral Brown

* Fornito assemblato su rete, da posizionarsi/inclinarsi in opera. Assemblaggio ad inclinazione flessibile fino a max 10%
 Supplied on mesh to be positioned/adapted on site. Assembly with flexible slope up to max 10%
 Fourni assemblé sur grille, à positionner/incliner sur chantier. Assemblage flexible avec pentes jusqu'à 10%
 Wird auf Netz montiert geliefert, auf der Baustelle zu positionieren neigen. Flexibel Montage mit Neigungen bis max 10%

Sistema finlandese

FINNISH SYSTEM
SYSTEME FINLANDAIS
SYSTEM FINNLAND

BORDI FINLANDESE SENZA AGGRAPPO FINNISH POOL BORDERS WITHOUT FINGER GRIP TÊTES FINLANDAISES SANS ACCROCHE DOIGTS
BECKENKÖPFEN FINNLAND OHNE HANDFASS

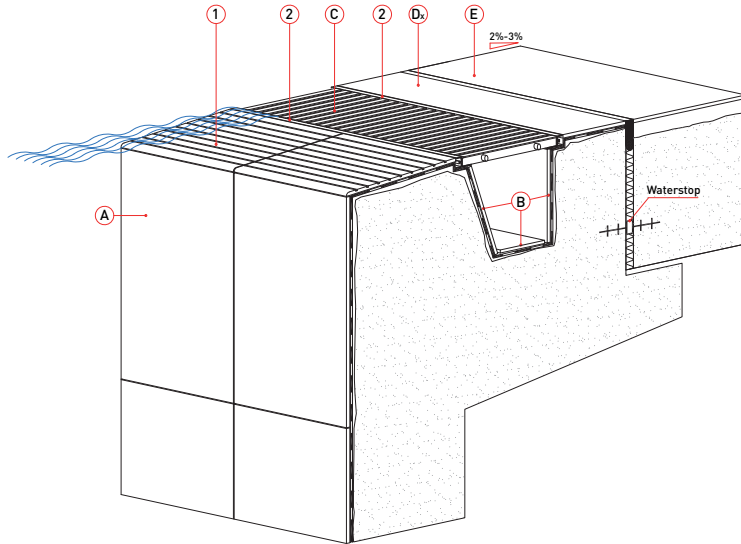

mod. FMIN 002

- A** MINERAL CHROM - Soft_interno vasca / pool tank / interieur bassin / becken
- B** MINERAL CHROM - Soft_canaletta di ricircolo / overflow channel / caniveau eau bassin / rinne
- C** PADANA GRID_griglia in pvc / grating in pvc / grille en pvc / pvc rost
- D** MINERAL CHROM - Naturale_pezzo di connessione spiaggia / pool deck connection piece / piece de connexion plage / verbindungsstück
- E** MINERAL CHROM - Naturale_esterno vasca / pool surround / plage / beckenumgang

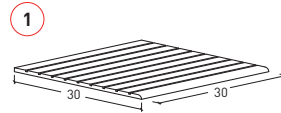

9876

MINERAL CHROM - Naturale

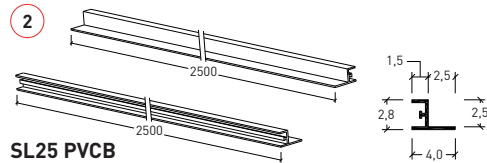

SL25 PVCB

Padana-Grid

Supporto griglia in pvc / Pvc grating support / Corniere in pvc / Pvc rost traeger

x = Dimensione variabile dell'articolo, da tagliare in cantiere
Item with variable dimensions, to be cut on site
Dimensions de l'article variables, à couper sur le chantier
Variable Größe des Artikels, vor Ort zu schneiden

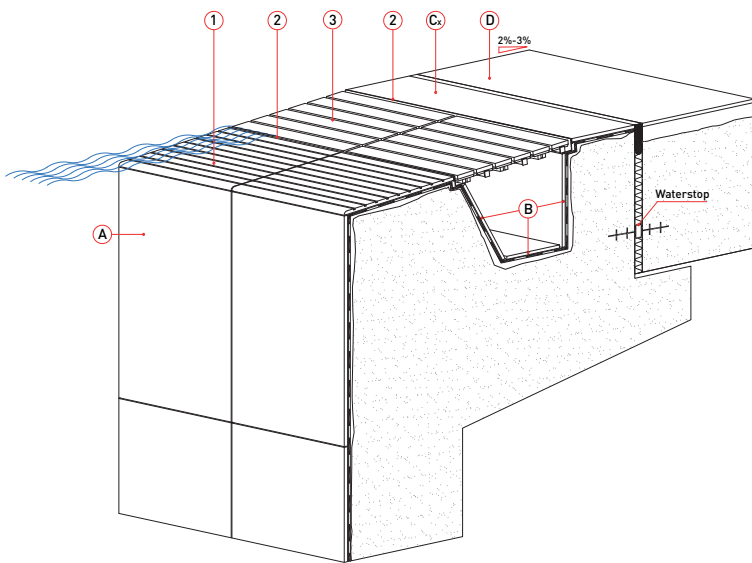

mod. FMIN 005.1

- A** MINERAL CHROM - Soft_interno vasca / pool tank / interieur bassin / becken
- B** MINERAL CHROM - Soft_canaletta di ricircolo / overflow channel / caniveau eau bassin / rinne
- C** MINERAL CHROM - Naturale_pezzo di connessione spiaggia / pool deck connection piece / piece de connexion plage / verbindungsstück
- D** MINERAL CHROM - Naturale_esterno vasca / pool surround / plage / beckenumgang

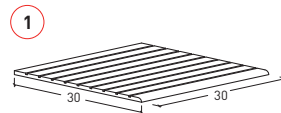

9876

MINERAL CHROM

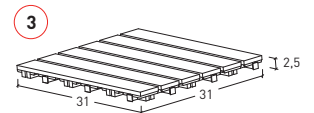

9842

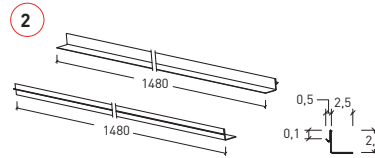

SL25 - IR16

Supporto griglia in acciaio inox / Stainless steel grating support / Support de grille inox / Rostträger aus Edelstahl

x = Dimensione variabile dell'articolo, da tagliare in cantiere
Item with variable dimensions, to be cut on site
Dimensions de l'article variables, à couper sur le chantier
Variable Größe des Artikels, vor Ort zu schneiden

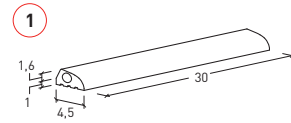
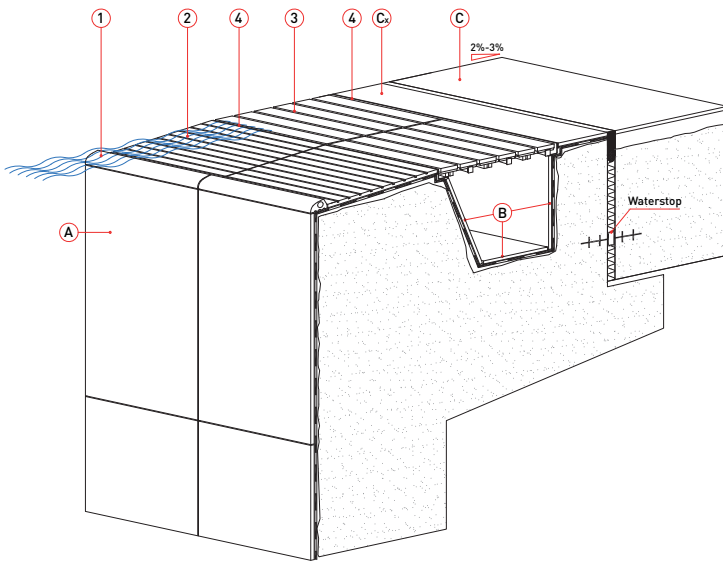

9840
Trim-Box



9870

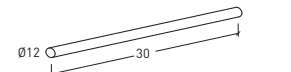

P 214-0296
Polyfill profilo / profile / profil / Profil*

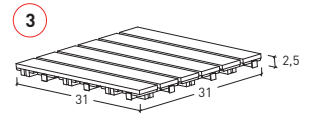

9842

* Vedi pagina: See page: Voir page: Siehe Seite: 42

MINERAL CHROM

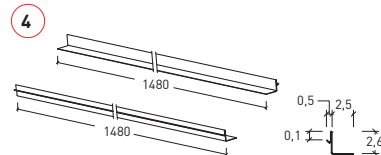

SL25 - IR16

Supporto griglia in acciaio inox / Stainless steel grating support / Support de grille inox / Rostträger aus Edelstahl

x= Dimensione variabile dell'articolo, da tagliare in cantiere
Item with variable dimensions, to be cut on site
Dimensions de l'article variables, à couper sur le chantier
Variable Größe des Artikels, vor Ort zu schneiden

mod. FMIN 001.5

- A** MINERAL CHROM - Soft_interno vasca / pool tank / interieur bassin / becken
- B** MINERAL CHROM - Soft_canaletta di ricircolo / overflow channel / caniveau eau bassin / rinne
- C** MINERAL CHROM - Naturale_pezzo di connessione spiaggia / pool deck connection piece / piece de connexion plage / verbindungsstück
- D** MINERAL CHROM - Naturale_esterno vasca / pool surround / plage / beckenumgang



Sistema Wiesbaden

WIESBADEN SYSTEM
SYSTEME WIESBADEN
SYSTEM WIESBADEN

BORDI WIESBADEN A PAVIMENTO WIESBADEN POOL BORDERS HIGH-LEVEL TÊTES WIESBADEN SURFLOT BECKENKÖPFEN WIESBADEN HOCHLIEGEND

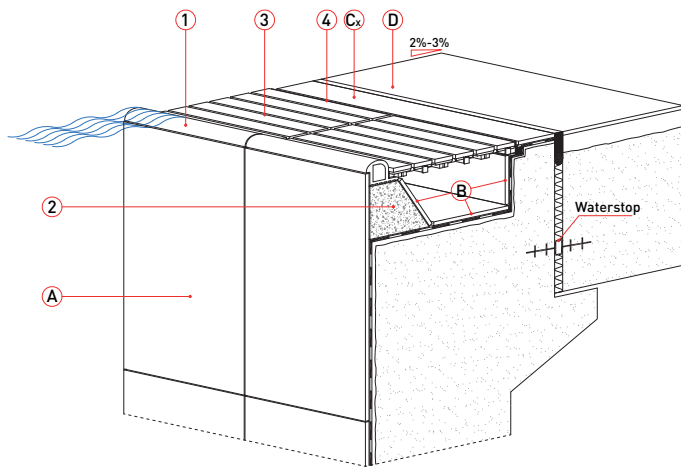

mod. WMIN 001.2

- A** MINERAL CHROM - Soft_interno vasca / pool tank / interieur bassin / becken
- B** MINERAL CHROM - Soft_canaletta di ricircolo / overflow channel / caniveau eau bassin / rinne
- C** MINERAL CHROM - Naturale_pezzo di connessione spiaggia / pool deck connection piece / piece de connexion plage / verbindungsstück
- D** MINERAL CHROM - Naturale_esterno vasca / pool surround / plage / beckenumgang

x= Dimensione variabile dell'articolo, da tagliare in cantiere
Item with variable dimensions, to be cut on site
Dimensions de l'article variables, à couper sur le chantier
Variable Größe des Artikels, vor Ort zu schneiden

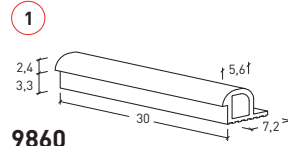

9860
Trim-Box

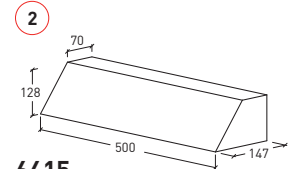

6415
Betonbuild

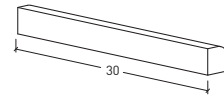

P 310-0296
Polyfill profilo / profile / profil / Profil*

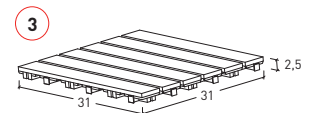

9842

* Vedi pagina: See page: Voir page: Siehe Seite: 42

MINERAL CHROM

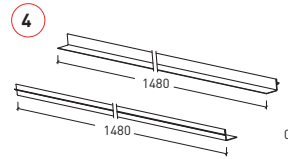

SL25 - IR16

Supporto griglia in acciaio inox / Stainless steel grating support / Support de grille inox / Rosträger aus Edelstahl

BORDO WIESBADEN A PARETE WIESBADEN POOL BORDER LOW-LEVEL TÊTE WIESBADEN EN PAROI BECKENKÖPFEN WIESBADEN TIEFLIEGEND

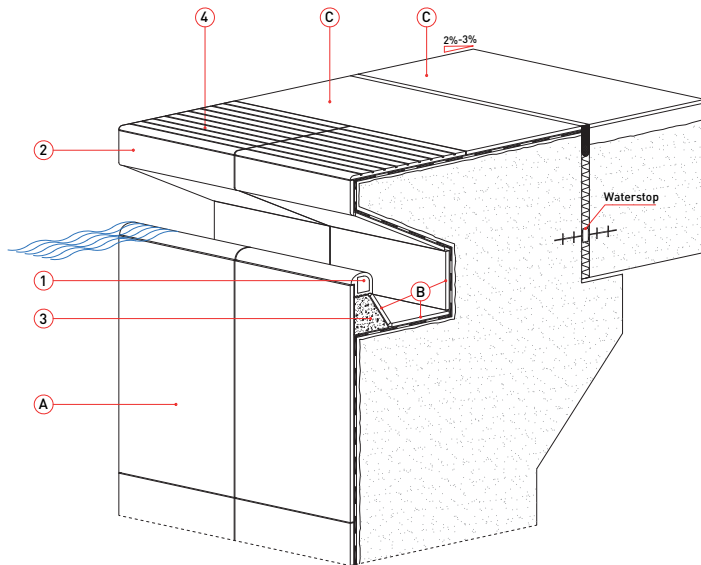

mod. WMIN 005.1

- A** MINERAL CHROM - Soft_interno vasca / pool tank / interieur bassin / becken
- B** MINERAL CHROM - Soft_canaletta di ricircolo / overflow channel / caniveau eau bassin / rinne
- C** MINERAL CHROM - Naturale_esterno vasca / pool surround / plage / beckenumgang

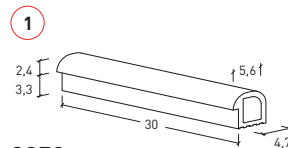

9850

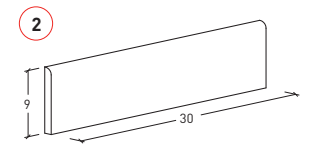

BATTISCOPA B.C. 9x30



P 310-0296
Polyfill profilo / profile / profil / Profil*

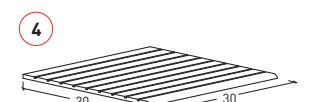

9876

* Vedi pagina: See page: Voir page: Siehe Seite: 42

MINERAL CHROM

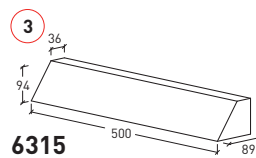

6315
Betonbuild



Sistema a Skimmer

SKIMMER SYSTEM
SYSTEME SKIMMER
SYSTEM SKIMMER

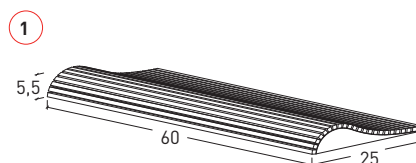
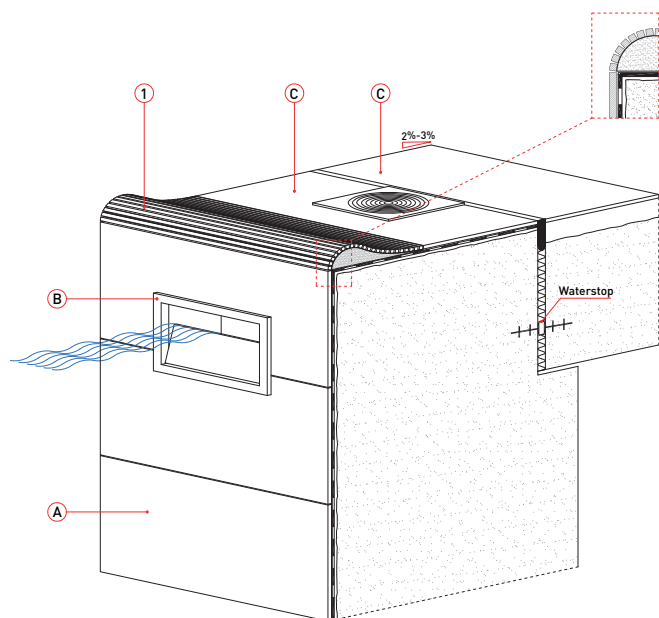

9660 - Pool Wave

MINERAL CHROM - Naturale



mod. SKMIN 9660

- A** MINERAL CHROM - Soft_interno vasca / pool tank / interieur bassin / becken
- B** Skimmer
- C** MINERAL CHROM - Naturale_esterno vasca / pool surround / plage / beckenumgang



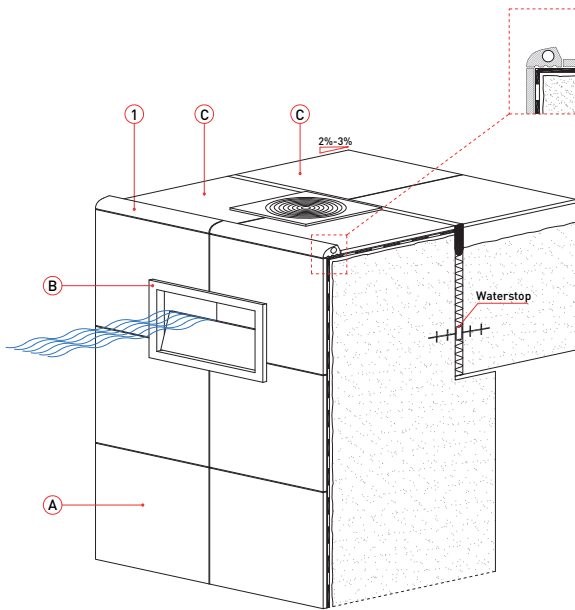

mod. SKMIN 9840

- A MINERAL CHROM - Soft_interno vasca / pool tank / interieur bassin / becken
- B Skimmer
- C MINERAL CHROM - Naturale_esterno vasca / pool surround / plage / beckenumgang

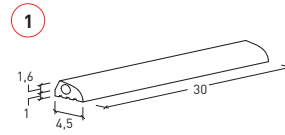

9840

Trim-Box

MINERAL CHROM

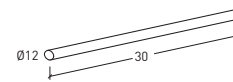

P 214-0296

Polyfill profilo / profile / profil / Profil*

* Vedi pagina: See page: Voir page: Siehe Seite: 42

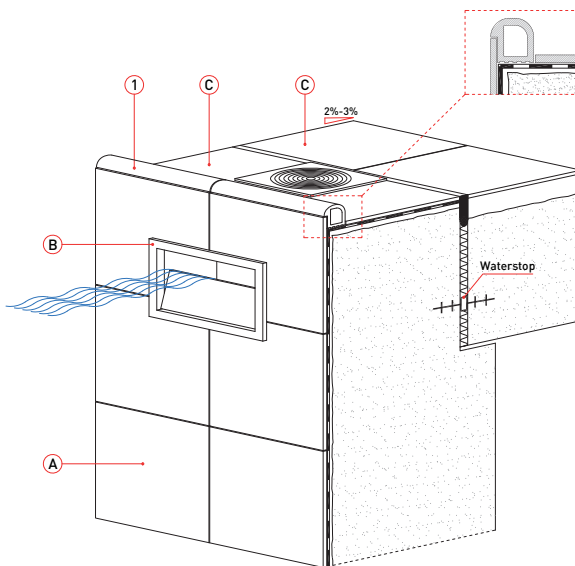

mod. SKMIN 9850

- A MINERAL CHROM - Soft_interno vasca / pool tank / interieur bassin / becken
- B Skimmer
- C MINERAL CHROM - Naturale_esterno vasca / pool surround / plage / beckenumgang

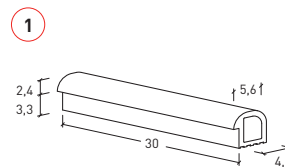

9850

MINERAL CHROM

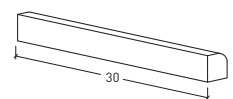

P 310-0296

Polyfill profilo / profile / profil / Profil*

* Vedi pagina: See page: Voir page: Siehe Seite: 42

Scale e gradini immersi in acqua

IMMERGED STAIRS AND STEPS
 ESCALIERS ET MARCHES IMMERGÉES DANS L'EAU
 TREPPEN UND STUFEN INS WASSER

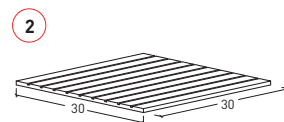
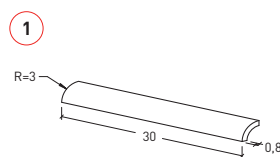
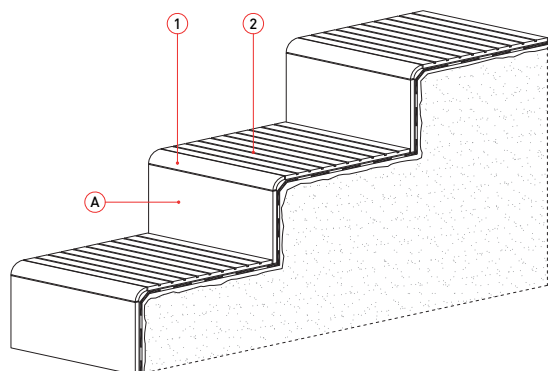

9835

MINERAL CHROM



9870

MINERAL CHROM - Naturale



mod. SCMIN 01

A MINERAL CHROM - Soft
 alzata / tread riser / contremarche / setzstufe



scale e gradini immersi in acqua / immersed stairs and steps / escaliers et marches immergées dans l'eau /
treppen und stufen ins wasser

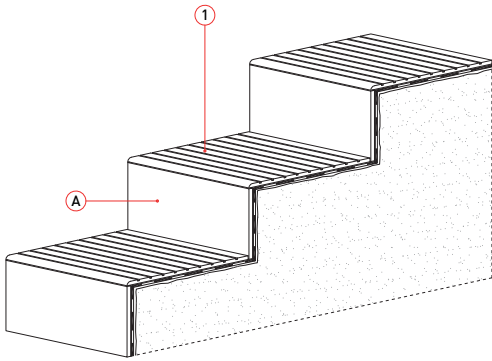

mod. SCMIN 03

A MINERAL CHROM - Soft
alzata / tread riser / contremarche / setzstufe

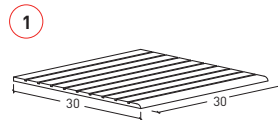

9876

MINERAL CHROM - Naturale

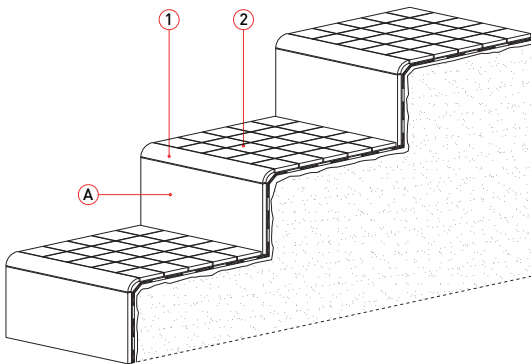

mod. SCMIN 04

A MINERAL CHROM - Soft
alzata / tread riser / contremarche / setzstufe

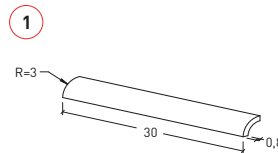

9835

MINERAL CHROM

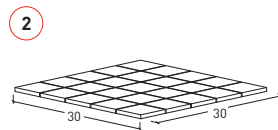

MOSAICO 6x6

MINERAL CHROM



Muretti di testata e muretti

HEADWALLS AND FENCES
 QUAIS DE DÉPART ET MURETS
 STIRNWÄNDE UND MAUERN

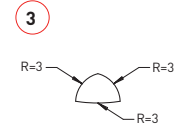
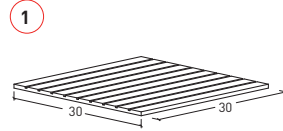
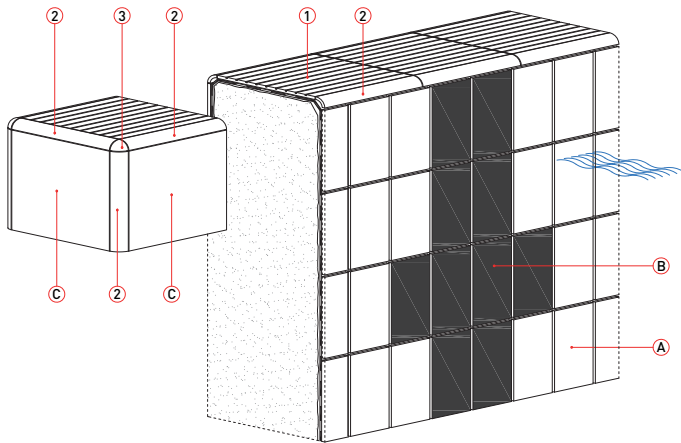

9870

MINERAL CHROM - Naturale



9837

MINERAL CHROM

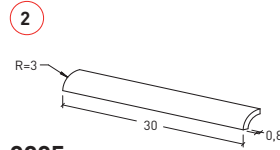

9835

MINERAL CHROM



mod. QDMIN 02

- A LANDSCAPE - Friction_fascia di virata / turning area / zone de virage / wandflaeche
- B LANDSCAPE - Friction_vie di corsa / marking lanes / ligne de nage / bahnamarkierungen
- C MINERAL CHROM - Soft_rivestimento esterno / external wall / revetement exterieur / wandbekleidung



muretti di testata e muretti / headwalls and fences / quais de départ et murets / stirnwände und Mauern

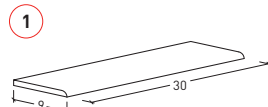
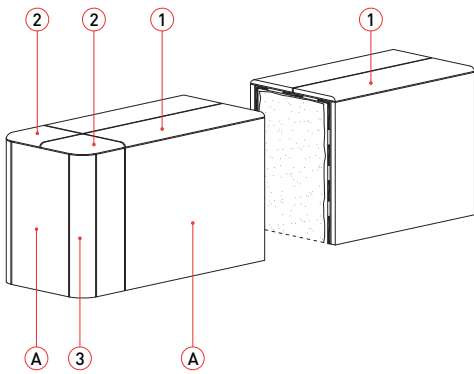

1
Terminale Gradino B.C. 9x30

MINERAL CHROM - Naturale

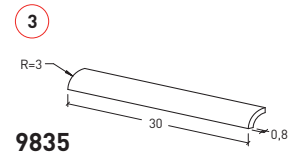

3
9835

MINERAL CHROM



mod. MUMIN 01

A MINERAL CHROM - Soft
rivestimento / wall tiling / revetement / wandfliesen

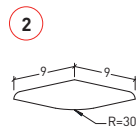

2
9900 Angolo Terminale Gradino B.C. 9x9

MINERAL CHROM - Naturale

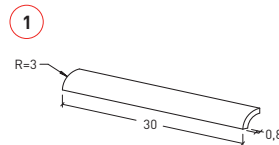
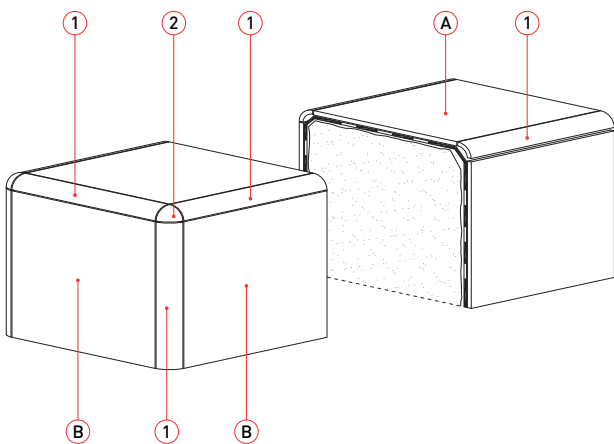

1
9835

MINERAL CHROM

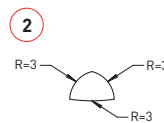

2
9837

MINERAL CHROM



mod. MUMIN 02

A MINERAL CHROM - Naturale_rivestimento / wall tiling / revetement / wandfliesen
B MINERAL CHROM - Soft_rivestimento / wall tiling / revetement / wandfliesen

Angoli e spigoli arrotondati

ROUNDED IN-CORNERS AND OUT-CORNERS
 ANGLES SORTANTS ET RENTRANTS ARRONDIS
 GERUNDETE KANTEN UND ECKEN

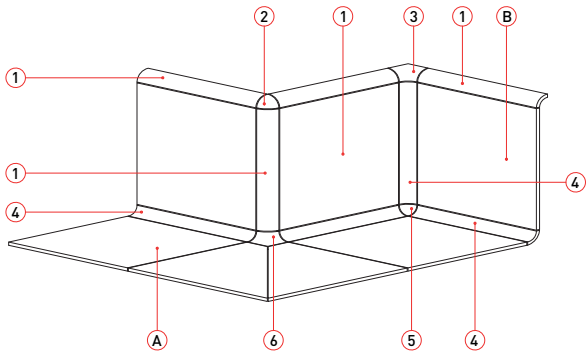

mod. FIMIN 01

A MINERAL CHROM - Naturale_pavimento / floor / carrelage de sol / bodenfliesen
B MINERAL CHROM - Soft_rivestimento / wall tiling / revetement / wandfliesen

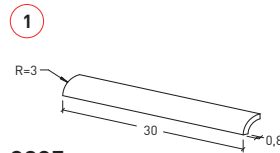

9835

MINERAL CHROM

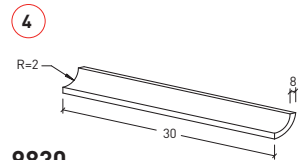

9830

MINERAL CHROM

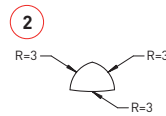

9837

MINERAL CHROM

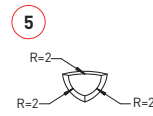
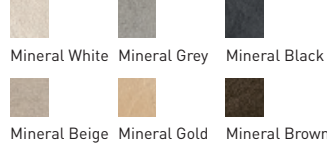

9833

MINERAL CHROM

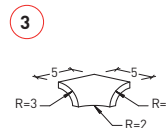
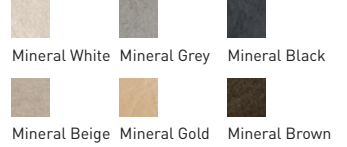

9838

MINERAL CHROM

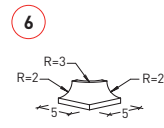

9834

MINERAL CHROM



angoli e spigoli arrotondati / rounded in-corners and out-corners / angles sortants et rentrants arrondis / gerundete kanten und ecken

vasche lavapiedi / feet washers / pédiluves / durchschreitbecken

Vasche lavapiedi

FEET WASHERS
PÉDILUVES
DURCHSCHREITBECKEN

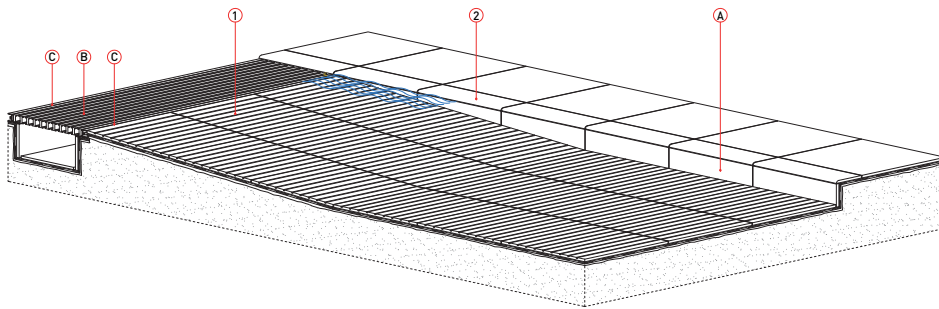

mod. PEMIN 01

- A MINERAL CHROM - Soft_rivestimento / wall tiling / revetement / wandfliesen
- B PADANA GRID_griglia in pvc / grating in pvc / grille en pvc / pvc rost
- C PADANA GRID_angolare in pvc / pvc grating support / corniere en pvc / pvc rost traeger

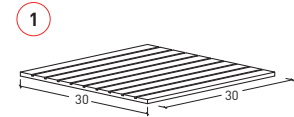

9870

MINERAL CHROM - Naturale

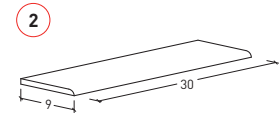

Terminale Gradino B.C. 9x30

MINERAL CHROM - Naturale



Amazzonia

PIETRE NATIVE

La serie Amazzonia, in gres fine porcellanato ha una superficie caratterizzata dalla leggera ruvidezza che si ispira alle pietre naturali più rare preziose, riproducendone fedelmente superfici, venature e cromatismi. È disponibile in cinque formati ed in otto colori dalla stonizzazione accentuata che valorizza la matericità del prodotto.

Tutti i colori e formati della Serie Amazzonia sono disponibili con superficie Naturale con classe antiscivolo R10-A e superficie Grip con classe antiscivolo R12-C. Su richiesta, nel solo formato 30x60 cm (rettificato), i colori della Serie Amazzonia sono disponibili anche con la superficie Semi-Grip che offre una classe antiscivolo R11-B. Completano la serie mosaici, decori e pezzi speciali per il rivestimento di piscine, spa ed esterni vasche indoor ed outdoor.

The porcelain tiles of the Amazzonia range take inspiration from the rarest and most precious natural stones and faithfully reproduce their textures, shades, veins and colours. It is available in five sizes and eight colours with impressive stone effects that make the most of the product's texture. Mosaics, decorations and fittings complete the products range and offer different technical and aesthetic solutions for public and private swimming pools, both indoors and outdoors.

All colours and sizes of Series Amazzonia are manufactured with both surface Naturale (R10-A) and surface Grip (R12-C). On demand, for the size 30x60 cm (rectified) only, the colours of Series Amazzonia can be produced with surface Semi-Grip offering a non slip rate R11-B. Provide the possibility to properly tile dry and wet areas as well as wall claddings.

La série Amazzonia, carreaux et dalles en grès cérame, s'inspire des pierres naturelles les plus rares et les plus précieuses, en reproduisant fidèlement leurs surfaces, veines et chromatismes. Disponible en cinq formats et huit couleurs avec des estompages éclatants qui montent en exergue la matérialité du produit, elle est complétée par des mosaïques, décorations et pièces spéciales permettant de réaliser les finitions typiques des piscines publiques, d'hôtels et particulières d'intérieur et d'extérieur.

Toutes les couleurs et les formats de la Serie Amazzonia sont fabriqués avec finition Naturelle (R10-A) et avec finition Grip (R12-C). Sur demande, dans le format 30x60 cm (rectifié) toutes les couleurs sont fabriquées aussi avec la finition Semi-Grip classée R11-B. Permettent de créer une continuité esthétique entre les zones sèches et les zones mouillées, ainsi qu'entre les planchers et les revêtements.

Zur Serie Amazzonia gehören Platten aus Feinsteinzeug, die sich an den seltensten und kostbarsten Natursteinen inspirieren und ihre Texturen, Äderungen und Farben getreu nachgestalten. Verfügbar in fünf Formaten und acht Farben mit ausgeprägten Tonabweichungen, die das Material des Produktes aufwerten. Dazu gehören Mosaik, Dekore und Formstücke, mit denen die typischen Veredelungen der öffentlichen und privaten Schwimmbäder Indoor- und Outdoor gestaltet werden können.

Alle Farben und Größen der Serie Amazzonia sind in der Oberfläche Natur mit Rutschfestigkeit R10-A erhältlich und in der Oberfläche Grip mit Rutsch-Klasse R12-C. Auf Anfrage und nur im Format 30x60 cm (rektifiziert) sind die Fliesen der Serie Amazzonia auch in der Oberfläche Semi-Grip (Rutschklasse R11-B) erhältlich. Lassen sich ästhetisch kontinuierliche Übergänge von Trocken- auf Nassbereiche und von Boden- auf Wandflächen gestalten.





naturale



grip

Formati Sizes Formats Formate	cm 30x30 11 ³ / ₄ "x11 ³ / ₄ "	cm 45x45 17 ³ / ₄ "x17 ³ / ₄ "	cm 30x60 11 ³ / ₄ "x23 ⁵ / ₈ "	cm 60x60 23 ⁵ / ₈ "x23 ⁵ / ₈ "	cm 45x90 17 ³ / ₄ "x35 ³ / ₈ "	cm 45x90 17 ³ / ₄ "x35 ³ / ₈ "
Superfici Surfaces Surfaces Oberflächen	● ●	● ●	● ● ● *	● ●	● ●	●
▼ ▲	mm 9	mm 10	mm 10 mm 9 mm 9**	mm 10	mm 10	mm 20***

● Naturale ^[1]

DIN 51097 A	XP P 05-010 PN 12	
DIN 51130 R 10	XP P 05-010 PC 10	

● Grip ^[2]

DIN 51097 C	XP P 05-010 PN 24	
DIN 51130 R 12	XP P 05-010 PC 27	

● Semi-Grip* ^[2]

DIN 51097 B	XP P 05-010 PN 18	
DIN 51130 R 11	XP P 05-010 PC 20	

Rettificate in un unico calibro Rectified version in a single caliber Rectifiés en un unique calibre Boden Sie in einem einzigen Kaliber

* Superficie Semi-Grip solo su richiesta e solo rettificato 9 mm Surface Semi-Grip on request only and rectified 9 mm only Surface Semi-Grip uniquement sur demande en version rectifiée 9 mm Oberfläche Semi-Grip nur auf Anfrage und nur kalibriert 9 mm

** Non rettificato (solo superficie Naturale o Grip) Unrectified (surface Naturale or Grip only) Non rectifié (surface Naturale ou Grip uniquement) Nicht kalibriert (Nur Naturale oder Grip Oberfläche)

*** Solo nei colori: Only in the colours: Seulement dans les couleurs: Nur in die Farben: **Dragon Black, Dragon Grey, Dragon Beige, Dragon White, Dragon Brown**

^[1] A pavimento: zone asciutte Floor: dry zones Revêtement de sol : zones sèches Boden: trokenzonen

^[2] A pavimento: zone asciutte e zone umide Floor: dry zones and wet zones Revêtement de sol : zones sèches et zones humides Boden: trokenzonen und feuchtenzonen

Caratteristiche tecniche a pagina: Technical features on page: Caractéristiques techniques à la page: Technische Eigenschaften auf Seite: **235**

AMAZZONIA

Dragon Black



Dragon Green



Dragon Grey



Dragon White



Dragon Brown



Dragon Beige



Eldorado



Accentuata
Accentuated
Importante
Starke

Vedi pagina: See page: Voir page: Siehe Seite: **237**

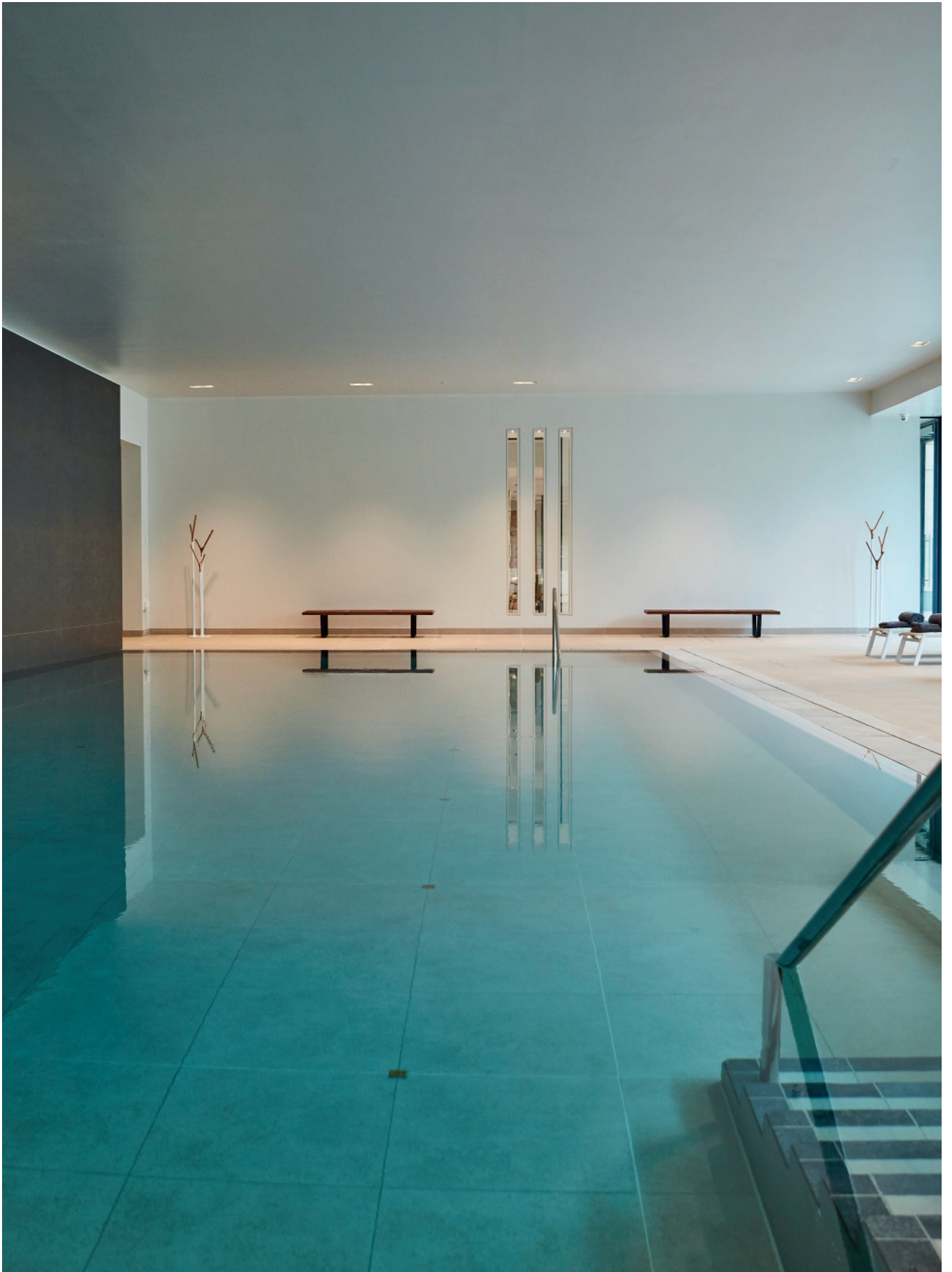

AMAZZONIA

MOSAICI*

Mosaico Amazonia 3x3

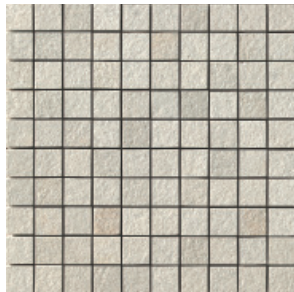

30x30 cm 11^{3/4}"x11^{3/4}"
3x3 cm 1^{1/8}"x1^{1/8}"

Standard su rete
Standard on net
Standard sur trame
Standard auf Netz

Su richiesta con rete davanti
On demand with net on front side
Sur demande avec trame sulla belle face
Auf Anfrage mit Netz auf Vorderseite

Mosaico Amazonia 6x6



30x30 cm 11^{3/4}"x11^{3/4}"
6x6 cm 2^{3/8}"x2^{3/8}"

Standard su rete
Standard on net
Standard sur trame
Standard auf Netz

Su richiesta con rete davanti
On demand with net on front side
Sur demande avec trame sulla belle face
Auf Anfrage mit Netz auf Vorderseite

Vedi dettagli a pagina: See details on page: Voir détails à la page: Siehe Details auf Seite: **238**

DECORI*

Composizione A



30x60 cm 11^{3/4}"x23^{5/8}"
su rete / on net / sur trame / auf Netz

PIASTRELLE NUMERATE*

Art. D400

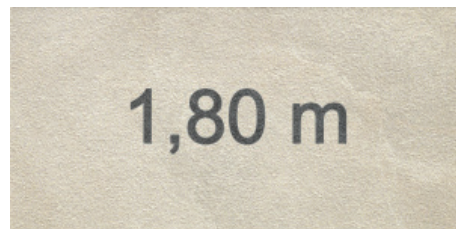

GRIGLIE CERAMICHE**

Art. 9742



Art. 9842



* Disponibile in tutti i colori della serie su superficie Naturale. A richiesta su superficie Grip Available in all the colours with surface Naturale. On request also on Grip surface Disponible dans toutes les couleurs pour la surface Naturale. Sur demande la finition Grip Verfügbar in allen Farben der Serie mit Oberfläche Naturale. Auf Anfrage Grip Oberfläche

** Disponibili in tutti i colori con superficie Grip Available in all the colours with surface Grip Disponibles dans toutes les couleurs avec finition Grip Verfügbar in allen Farben mit Oberfläche Grip



GRADINI E TERMINALI GRADINO STEP TREADS MARCHES ET NEZ DE MARCHE STUFEN UND TREPPENPLATTEN

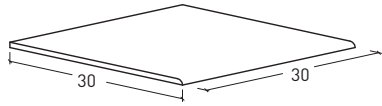

Gradino B.C. Grip 30x30 senza righe
12 pc/box 1,8 kg/pc

AMAZZONIA - Naturale/Grip

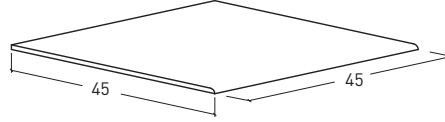

Gradino B.C. Grip 45x45 senza righe
5 pc/box 5,0 kg/pc

AMAZZONIA - Naturale/Grip

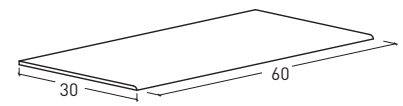

Gradino B.C. Grip 30x60 senza righe
6 pc/box 3,89 kg/pc

AMAZZONIA - Naturale/Grip

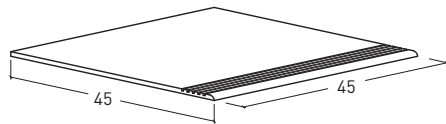

Gradino B.C. 45x45 con righe
5 pc/box 5,0 kg/pc

AMAZZONIA - Naturale

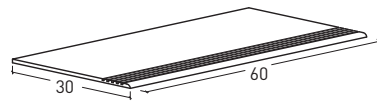

Gradino B.C. 30x60 con righe
6 pc/box 3,89 kg/pc

AMAZZONIA - Naturale

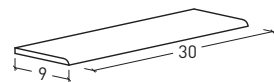

Bordo / Terminale Gradino B.C. 9x30
28 pc/box 0,5 kg/pc

AMAZZONIA - Naturale/Grip

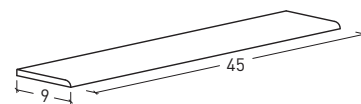

Bordo / Terminale Gradino B.C. 9x45
18 pc/box 0,75 kg/pc

AMAZZONIA - Grip

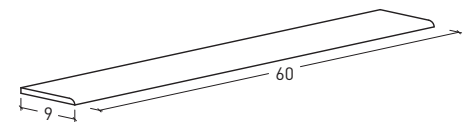

Bordo / Terminale Gradino B.C. 9x60
18 pc/box 1,0 kg/pc

AMAZZONIA - Grip

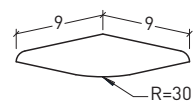

9900 Angolo Bordo / Terminale Gradino B.C. 9x9
10 pc/box 0,2 kg/pc

AMAZZONIA - Naturale/Grip



BATTISCOPA SKIRTING BORD ARRONDI SOCKEL

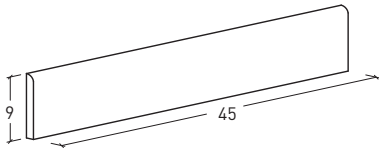

Battiscopa B.C. 9x45
18 pc/box 0,75 kg/pc

AMAZZONIA - Naturale

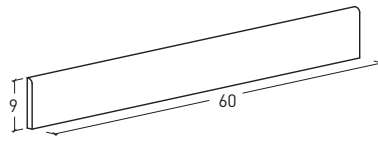

Battiscopa B.C. 9x60
18 pc/box 1,0 kg/pc

AMAZZONIA - Naturale



SGUSCIE E COPRI SPIGOLI COVES AND QUARTER ROUNDS GORGES ET QUARTS DE ROND HOHLKEHLEN UND RADIALEISTEN

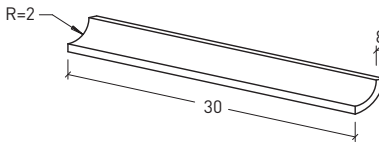

9830
48 pc/box 0,2 kg/pc

AMAZZONIA

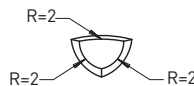

9833
10 pc/box 0,05 kg/pc

AMAZZONIA

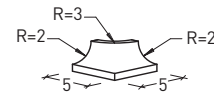

9834
10 pc/box 0,05 kg/pc

AMAZZONIA

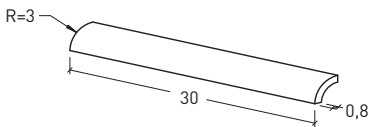

9835
48 pc/box 0,2 kg/pc

AMAZZONIA - Grip

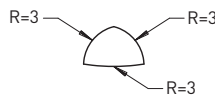

9837
10 pc/box 0,05 kg/pc

AMAZZONIA - Grip

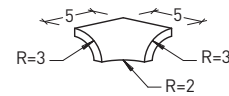

9838
10 pc/box 0,05 kg/pc

AMAZZONIA



AMAZZONIA

BORDO VASCA FINLANDESE FINNISH POOL BORDER TÊTE DE BASSIN FINLANDAISE BECKENKOPF FINNLAND

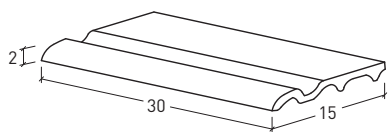

9846

10 pc/box 1,7 kg/pc

AMAZZONIA - Grip

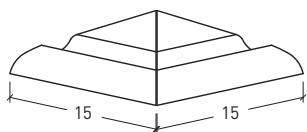

9847

10 pc/box 0,8 kg/pc

AMAZZONIA - Grip

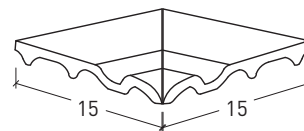

9848

10 pc/box 0,8 kg/pc

AMAZZONIA - Grip



AGGRAPPO FINGER-GRIP ACCROCHE DOIGTS HANDGRIFF

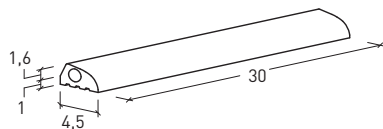

9840

Trim-Box 24 pc/box 0,8 kg/pc

AMAZZONIA

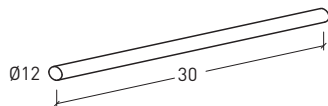

P 214-0296

Polyfill profilo / profile / profil / Profil*

* Vedi pagina: See page: Voir page: Siehe Seite: 42

BORDO VASCA WIESBADEN A PAVIMENTO POOL BORDER WIESBADEN HIGH-LEVEL TÊTE DE BASSIN WIESBADEN SURFLLOT BECKENKOPF WIESBADEN HOCHLIEGEND

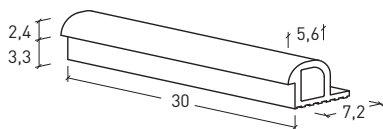

9860

Trim-Box 8 pc/box 0,96 kg/pc

AMAZZONIA

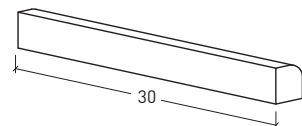

P 310-0296

Polyfill profilo / profile / profil / Profil*

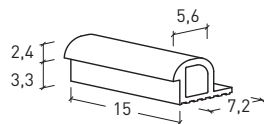

9862

Trim-Box 16 pc/box 0,48 kg/pc

AMAZZONIA

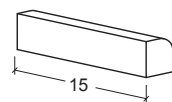

P 311-0147

Polyfill profilo / profile / profil / Profil*

* Vedi pagina: See page: Voir page: Siehe Seite: 42

SUPPORTO BETONBUILD CEMENTITIUS SUPPORT BETONBUILD SUPPORT EN BETON BETONBUILD TRÄGERELEMENT BETONBUILD

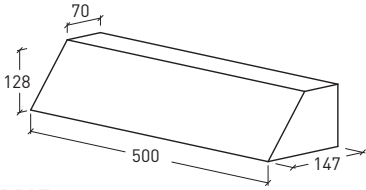

6415

Betonbuild 16,00 kg/pc 2 pc/ml

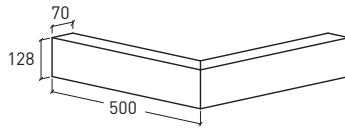

6417

Betonbuild 2 pc 45° 32,00 kg/pc

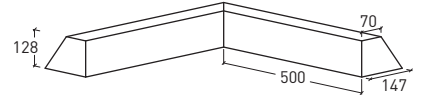

6418

Betonbuild 2 pc 45° 32,00 kg/pc

BORDO VASCA WIESBADEN A PARETE POOL BORDER WIESBADEN LOW-LEVEL TÊTE DE BASSIN WIESBADEN EN PAROI
BECKENKOPF ZÜRICH UND WIESBADEN TIEFLIEGEND

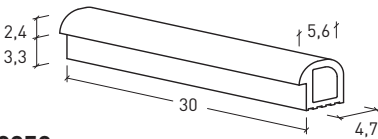

9850

8 pc/box 0,8 kg/pc

AMAZZONIA

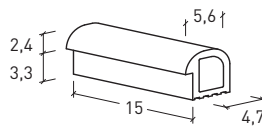

9852

16 pc/box 0,4 kg/pc

AMAZZONIA

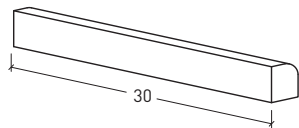

P 310-0296

Polyfill profilo / profile / profil / Profil*

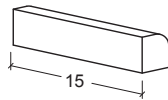

P 311-0147

Polyfill profilo / profile / profil / Profil*

* Vedi pagina: See page: Voir page: Siehe Seite: 42

SUPPORTO BETONBUILD CEMENTITIUS SUPPORT BETONBUILD SUPPORT EN BETON BETONBUILD TRÄGERELEMENT BETONBUILD

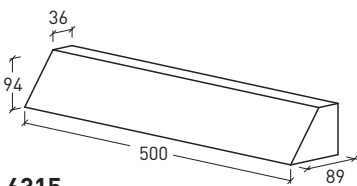

6315

Betonbuild 12,00 kg/pc 2 pc/ml

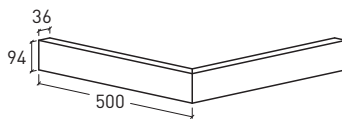

6317

Betonbuild 2 pc 45° 24,00 kg/pc

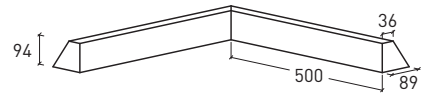

6318

Betonbuild 2 pc 45° 24,00 kg/pc



AMAZZONIA

BORDO VASCA SKIMMER SKIMMER POOL BORDER TÊTE DE BASSIN SKIMMER BECKENKOPF SKIMMER

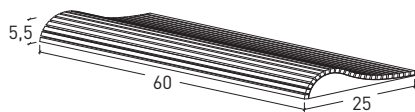

9660 - Pool Wave

1 pc/box 10,0 kg/pc

AMAZZONIA - Grip

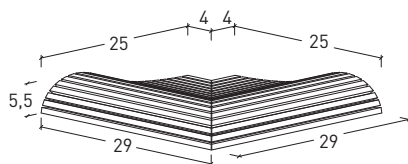

9667 - Pool Wave

2 pc 45° 1+1 pc/box 9,8 kg/pc

AMAZZONIA - Grip

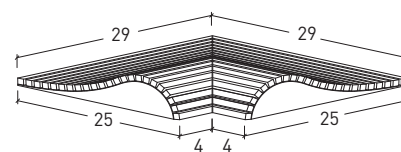

9668 - Pool Wave

2 pc 45° 1+1 pc/box 9,8 kg/pc

AMAZZONIA - Grip

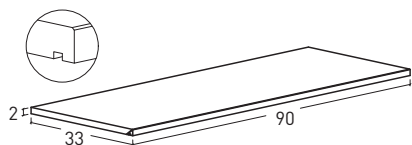

9560

2 pc/box 13,7 kg/pc

AMAZZONIA - Grip

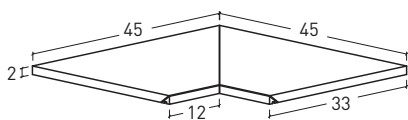
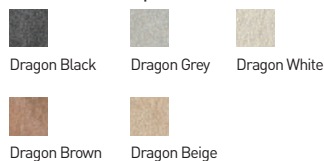

9568

2 pc 45° 1+1 pc/box 5,6 kg/pc

AMAZZONIA - Grip

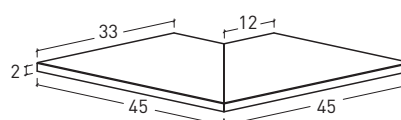
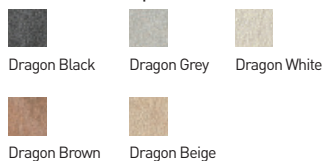

9567

2 pc 45° 1+1 pc/box 5,6 kg/pc

AMAZZONIA - Grip

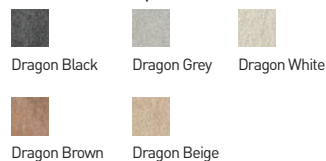

GRIGLIE IN CERAMICA PARALLELE PARALLEL CERAMIC GRATINGS GRILLES CÉRAMIQUES PARALLELES PARALLELE ROSTE AUS KERAMIK

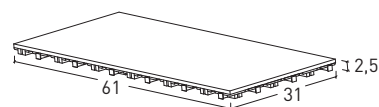

9742 ⁽¹⁾

3 pc/box 4,0 kg/pc

AMAZZONIA - Grip

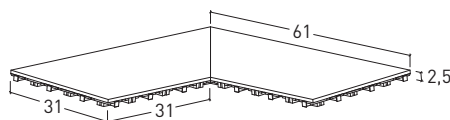

9743 ⁽¹⁾

2 pc 45° 2+2 pc/box 6,0 kg/pc

AMAZZONIA - Grip

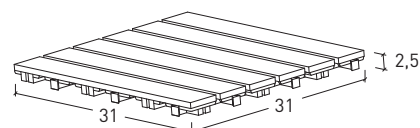

9842 ⁽²⁾

6 pc/box 2,3 kg/pc

AMAZZONIA - Grip

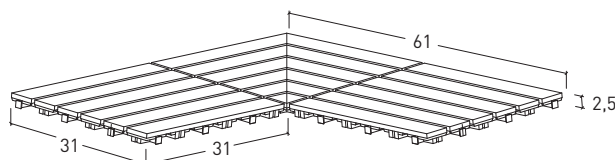

9843 ⁽²⁾

2 pc 45° 2+2 pc/box 7,9 kg/pc

AMAZZONIA - Grip



GRIGLIE IN CERAMICA PERPENDICOLARI PERPENDICULAR CERAMIC GRATINGS GRILLES CÉRAMIQUES PARALLELES RECHTWINKLIGE ROSTE AUS KERAMIK

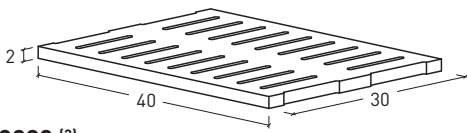

9883 ⁽³⁾

4 pc/box 5,0 kg/pc

AMAZZONIA - Grip

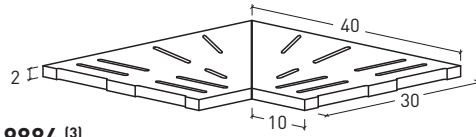

9884 ⁽³⁾

2 pc 45° 2+2 pc/box 4,5 kg/pc

AMAZZONIA - Grip



GRIGLIE IN CERAMICA PER CANALETTE SPIAGGIA PERPENDICULAR CERAMIC GRATINGS FOR DECK CHANNELS GRILLES CÉRAMIQUES PARALLELES POUR CANIVEAUX DE PLAGE RECHTWINKLIGE ROSTE AUS KERAMIK FÜR STRANDRINNEN EMPFOHLEN

Vedi pagina: See page: Voir page: Siehe Seite: 216

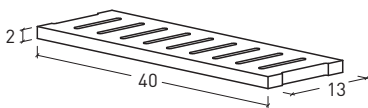

9885 ⁽⁴⁾

Padana-Deck 8 pc/box 2,0 kg/pc

AMAZZONIA - Grip

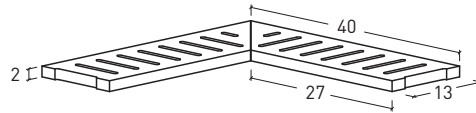

9886 ⁽⁴⁾

Padana-Deck 2 pc 45° 4+4 pc/box 3,5 kg/pc

AMAZZONIA - Grip



SUPPORTI GRIGLIA GRATING SUPPORTS SUPPORTS DE GRILLE ROSTAUFLAGER

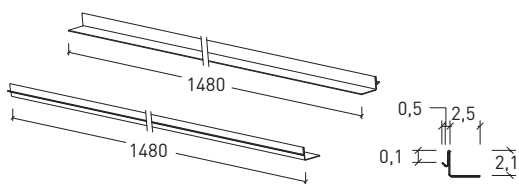

SL20 - IR16*

Supporto griglia in acciaio inox
Stainless steel grating support
Support de grille inox
Rostträger aus Edelstahl

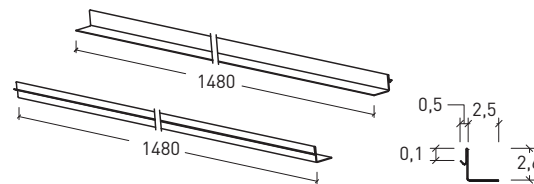

SL25 - IR16*

Supporto griglia in acciaio inox
Stainless steel grating support
Support de grille inox
Rostträger aus Edelstahl

* Articoli realizzati con acciaio inox AISI 316L-BA - EN 1.4404 (Lucido) / Classe di corrosività C4
Items made with stainless steel AISI 316L-BA - EN 1.4404 (Polished) / Corrosion Class C4
Références fabriquées en acier inox AISI 316L-BA - EN 1.4404 (Poli) / Catégorie de corrosivité C4
Artikel aus Edelstahl AISI 316L-BA - EN 1.4404 (Glanzend) / Korrosionsklasse C4

- ⁽¹⁾ Idoneità e geometria della griglia da verificare con i professionisti incaricati della progettazione della piscina e dei relativi impianti / Adequacy and geometry of the grating to be approved by the specialists in charge of the designing of the pool and of the related equipment / Adéquation et géométrie de la grille à bien vérifier par les responsables de la conception de la piscine et des installations associées / Eignung und Geometrie des Gitters sind mit den Fachleuten zu überprüfen, die für die Gestaltung des Pools und seiner Systeme verantwortlich sind.
- ⁽²⁾ Idoneità e geometria della griglia da verificare con i professionisti incaricati della progettazione della piscina e dei relativi impianti. Fuga tra griglia e supporto circa 7 mm. Fuga tra ciascun elemento posato circa 3 mm / Adequacy and geometry of the grating to be approved by the specialists in charge of the designing of the pool and of the related equipment. Joint between grating and screed approx. 7 mm. Joint between each element laid approx 3 mm / Adéquation et géométrie de la grille à bien vérifier par les responsables de la conception de la piscine et des installations associées. Joint entre grille et support d'environ 7 mm. Joint entre chaque élément posé environ 3 mm / Eignung und Geometrie des Gitters sind mit den Fachleuten zu überprüfen, die für die Gestaltung des Pools und seiner Systeme verantwortlich sind. Fuge zwischen Gitter und Stütze ca. 7 mm. Fuge zwischen jedem verlegten Element ca. 3 mm
- ⁽³⁾ Idoneità e geometria della griglia da verificare con i professionisti incaricati della progettazione della piscina e dei relativi impianti. Consigliata solo per piscine private / Adequacy and geometry of the grating to be approved by the specialists in charge of the designing of the pool and of the related equipment. Suggested for private pools only / Adéquation et géométrie de la grille à bien vérifier par les responsables de la conception de la piscine et des installations associées. Conseillée uniquement pour piscines privées / Eignung und Geometrie des Gitters sind mit den Fachleuten zu überprüfen, die für die Gestaltung des Pools und seiner Systeme verantwortlich sind. Nur für private Schwimmbäder
- ⁽⁴⁾ Consigliata solo per piscine private. Consigliata solo per canalette di spiaggia / Suggested for private pools only. Recommended for deck channels only / Conseillée uniquement pour piscines privées. Conseillée uniquement pour caniveaux de plage / Nur für private Schwimmbäder. Nur für Strandrinnen empfohlen

AMAZZONIA

PIASTRELLE DI INDICAZIONE MARKING TILES CARREAUX NUMEROTES ANZEIGEFLESSEN

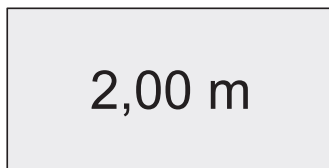

D400

Formato 30x60. Carattere Arial Narrow (altezza 7 cm - spessore 7mm)
 Size 30x60. Font Arian Narrow (height 7 cm - width 7 mm)
 Format 30x60. Caractère Arial Narrow (hauteur 7 cm - largeur 7 mm)
 Format 30x60. Schrifttyp Arial Narrow (Schriftöhe 7 cm - Schriftdicke 7 mm)

AMAZZONIA - Naturale/Grip



CANALETTA CERAMICA LINEARE CP007 ASSEMBLATA SU RETE LINEAR CERAMIC CHANNEL CP007 ASSEMBLED ON MESH CANIVEAU CERAMIQUE LINEAIRE CP007 ASSEMBLE SUR TREILLIS LINEARKERAMISCHE RINNE CP007 AUF NETS GEKLEBT

Vedi pagina: See page: Voir page: Siehe Seite: 213

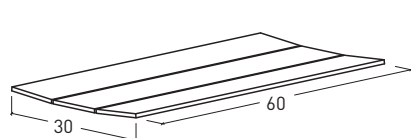

9795*

Padana-Deck 6 pc/box 10,0 kg/pc

AMAZZONIA

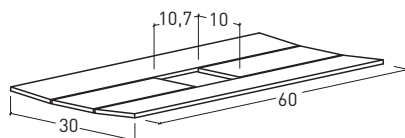

9796*

Padana-Deck 6 pc/box 9,8 kg/pc

AMAZZONIA

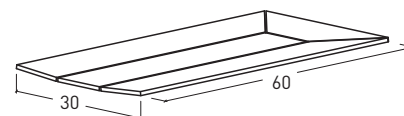

9797*

Padana-Deck 6 pc/box 9,8 kg/pc

AMAZZONIA



* Fornito assemblato su rete, da posizionarsi/inclinarsi in opera. Assemblaggio ad inclinazione flessibile fino a max 10%
 Supplied on mesh to be positioned/adapted on site. Assembly with flexible slope up to max 10%
 Fourni assemblé sur grille, à positionner/incliner sur chantier. Assemblage flexible avec pentes jusqu'à 10%
 Wird auf Netz montiert geliefert, auf der Baustelle zu positionieren neigen. Flexibel Montage mit Neigungen bis max 10%



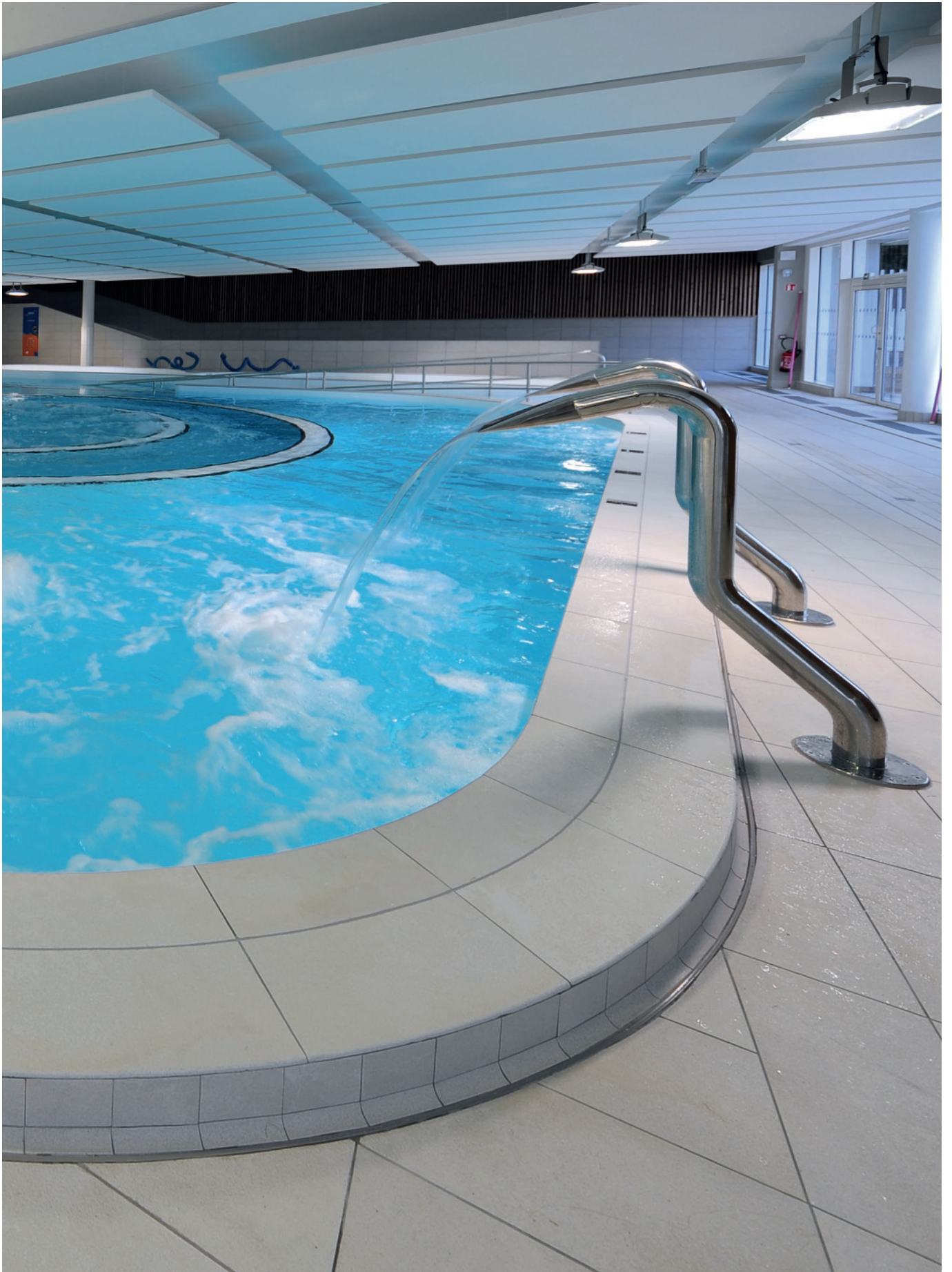

Sistema Finlandese

FINNISH SYSTEM
SYSTEME FINLANDAIS
SYSTEM FINNLAND

BORDI FINLANDESE SENZA AGGRAPPO FINNISH POOL BORDERS WITHOUT FINGER GRIP TÊTES FINLANDAISES SANS ACCROCHE DOIGTS
BECKENKÖPFEN FINNLAND OHNE HANDFASS

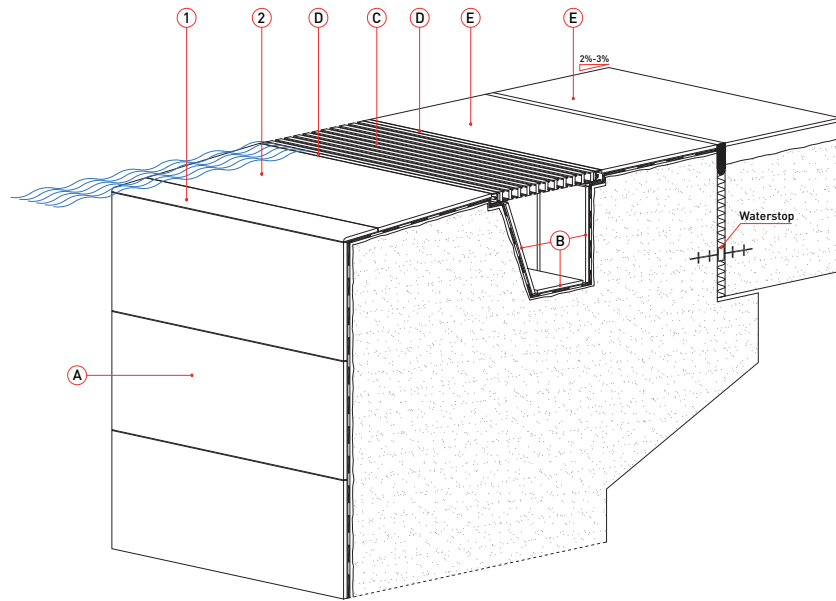

mod. FAMZ 002.3

- A** AMAZZONIA - Naturale_interno vasca / pool tank / interieur bassin / becken
- B** LANDSCAPE - Satin_canaletta di ricircolo / overflow channel / caniveau eau bassin / rinne
- C** PADANA GRID_griglia in pvc / grating in pvc / grille en pvc / pvc rost
- D** PADANA GRID_angolare in pvc / pvc grating support / corniere en pvc / pvc rost traeger
- E** AMAZZONIA - Grip_esterno vasca / pool surround / plage / beckenumgang

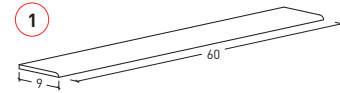

Bordo / Terminale Gradino B.C. 9x60

AMAZZONIA - Grip

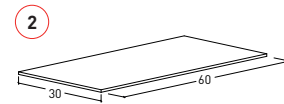

Amazzonia Grip 30x60

AMAZZONIA - Grip



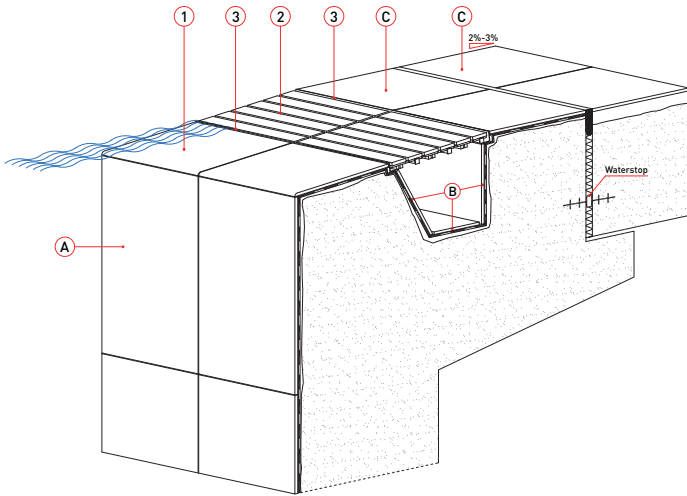

mod. FAMZ 002.6

- A** AMAZZONIA - Naturale_interno vasca / pool tank / interieur bassin / becken
- B** AMAZZONIA - Naturale_canaletta di ricircolo / overflow channel / caniveau eau bassin / rinne
- C** AMAZZONIA - Grip_esterno vasca / pool surround / plage / beckenumgang

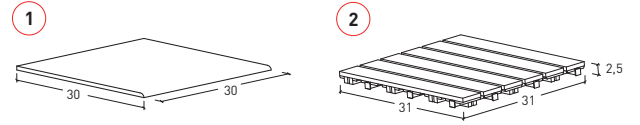

Gradino B.C. Grip 30x30 senza righe 9842

AMAZZONIA - Grip

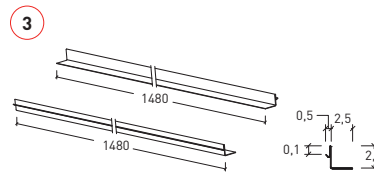
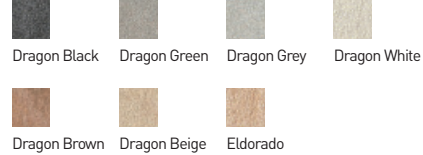

SL25 - IR16

Supporto griglia in acciaio inox
Stainless steel grating support
Support de grille inox
Rostträger aus Edelstahl

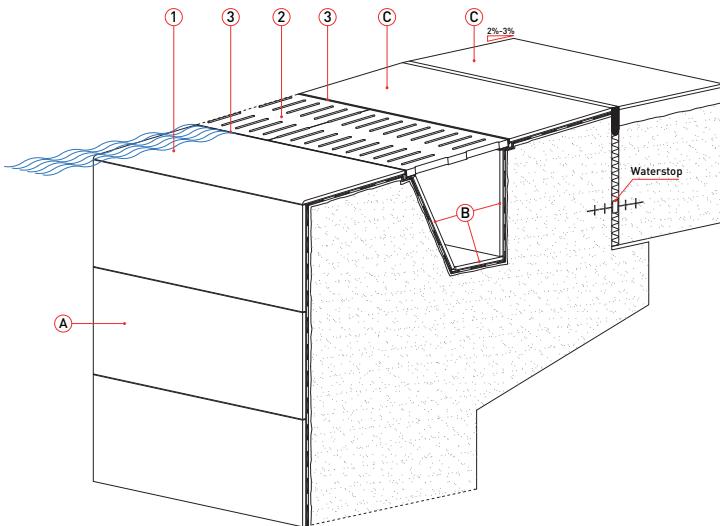

mod. FAMZ 002.7*

- A** AMAZZONIA - Naturale_interno vasca / pool tank / interieur bassin / becken
- B** AMAZZONIA - Naturale_canaletta di ricircolo / overflow channel / caniveau eau bassin / rinne
- C** AMAZZONIA - Grip_esterno vasca / pool surround / plage / beckenumgang

* Consigliato solo per piscine private / Suggested for private pools only /
Conseillées seulement pour piscines privées / Nur für private Schwimmbäder

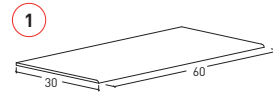

Gradino B.C. Grip 30x60 senza righe

AMAZZONIA - Grip

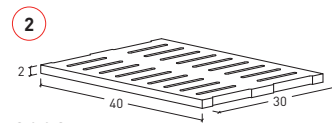

9883

AMAZZONIA - Grip

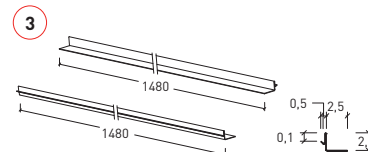

SL20 - IR16

Supporto griglia in acciaio inox
Stainless steel grating support
Support de grille inox
Rostträger aus Edelstahl

AMAZZONIA

BORDI FINLANDESE CON AGGRAPPO FINNISH POOL BORDERS WITH FINGER GRIP TÊTES FINLANDAISES AVEC ACCROCHE DOIGTS BECKENKÖPFEN FINNLAND MIT HANDFASS

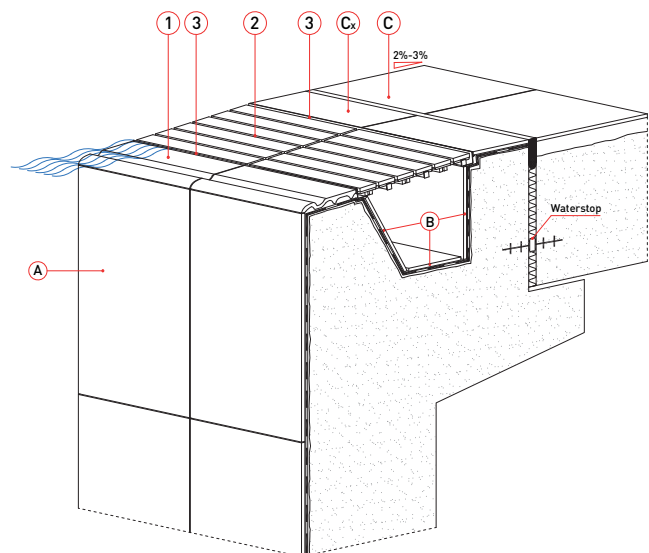

mod. FAMZ 001.3

- A** AMAZZONIA - Naturale_interno vasca / pool tank / interieur bassin / becken
- B** AMAZZONIA - Naturale_canaletta di ricircolo / overflow channel / caniveau eau bassin / rinne
- C** AMAZZONIA - Grip_esterno vasca / pool surround / plage / beckenumgang

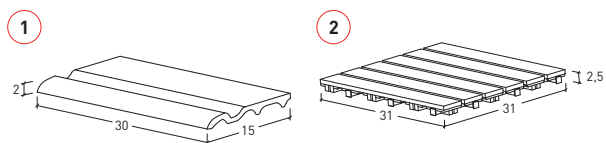

9846

9842

AMAZZONIA - Grip

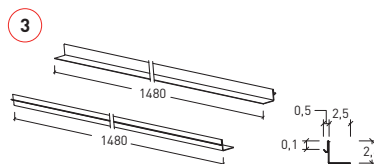

SL25 - IR16

Supporto griglia in acciaio inox / Stainless steel grating support / Support de grille inox / Rostträger aus Edelstahl

x = Dimensione variabile dell'articolo, da tagliare in cantiere
Item with variable dimensions, to be cut on site
Dimensions de l'article variables, à couper sur le chantier
Variable Größe des Artikels, vor Ort zu schneiden

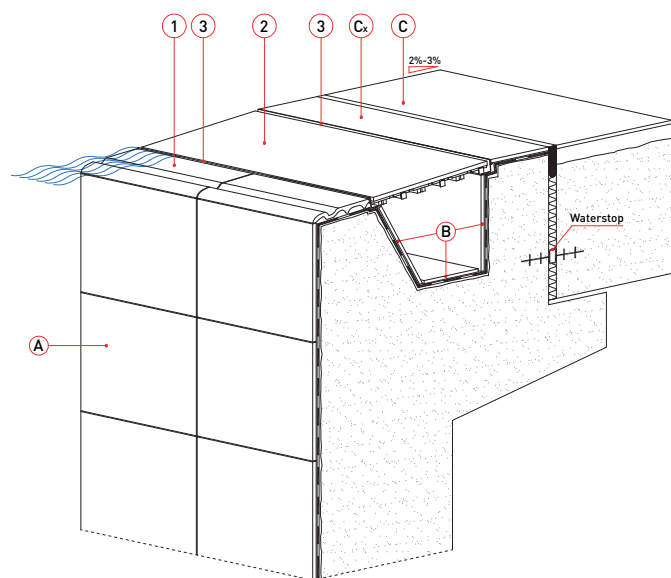

mod. FAMZ 001.4

- A** AMAZZONIA - Naturale_interno vasca / pool tank / interieur bassin / becken
- B** AMAZZONIA - Naturale_canaletta di ricircolo / overflow channel / caniveau eau bassin / rinne
- C** AMAZZONIA - Grip_esterno vasca / pool surround / plage / beckenumgang

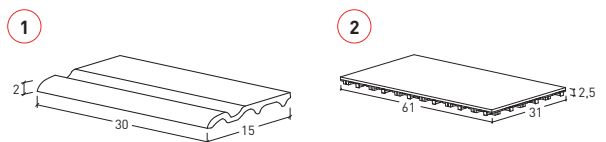

9846

9742

AMAZZONIA - Grip

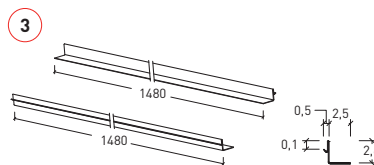

SL25 - IR16

Supporto griglia in acciaio inox / Stainless steel grating support / Support de grille inox / Rostträger aus Edelstahl

x = Dimensione variabile dell'articolo, da tagliare in cantiere
Item with variable dimensions, to be cut on site
Dimensions de l'article variables, à couper sur le chantier
Variable Größe des Artikels, vor Ort zu schneiden

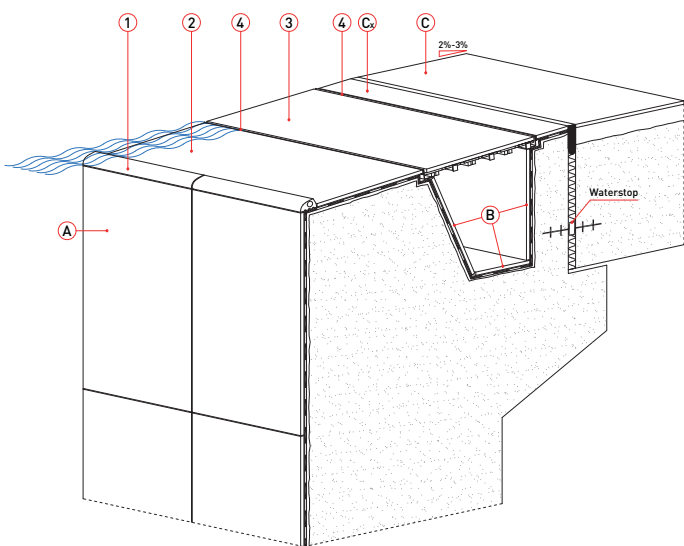

mod. FAMZ 006.0

- A** AMAZZONIA - Naturale_interno vasca / pool tank / interieur bassin / becken
- B** LANDSCAPE - Satin_canaletta di ricircolo / overflow channel / caniveau eau bassin / rinne
- C** AMAZZONIA - Grip_esterno vasca / pool surround / plage / beckenumgang

x = Dimensione variabile dell'articolo, da tagliare in cantiere
 Item with variable dimensions, to be cut on site
 Dimensions de l'article variables, à couper sur le chantier
 Variable Größe des Artikels, vor Ort zu schneiden

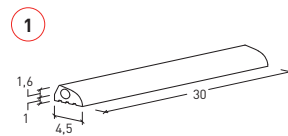

9840

Trim-Box

AMAZZONIA

- Dragon Black
- Dragon Grey
- Dragon White
- Dragon Beige



P 214-0296

Polyfill profilo / profile / profil / Profil*

* Vedi pagina: See page: Voir page: Siehe Seite: 42

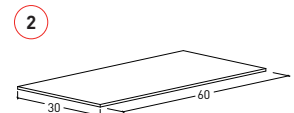

Amazonia Grip 30x60

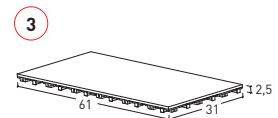

9742

AMAZZONIA - Grip

- Dragon Black
- Dragon Green
- Dragon Grey
- Dragon White
- Dragon Brown
- Dragon Beige

Elaborato

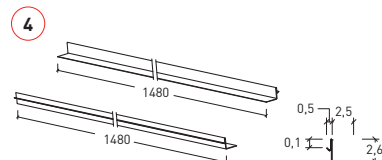

SL25 - IR16

Supporto griglia in acciaio inox / Stainless steel grating support / Support de grille inox / Rostträger aus Edelstahl

Sistema Wiesbaden

WIESBADEN SYSTEM
SYSTEME WIESBADEN
SYSTEM WIESBADEN

BORDI WIESBADEN A PAVIMENTO WIESBADEN POOL BORDERS HIGH-LEVEL TÊTES WIESBADEN SURFLÖT BECKENKÖPFEN WIESBADEN HOCHLIEGEND

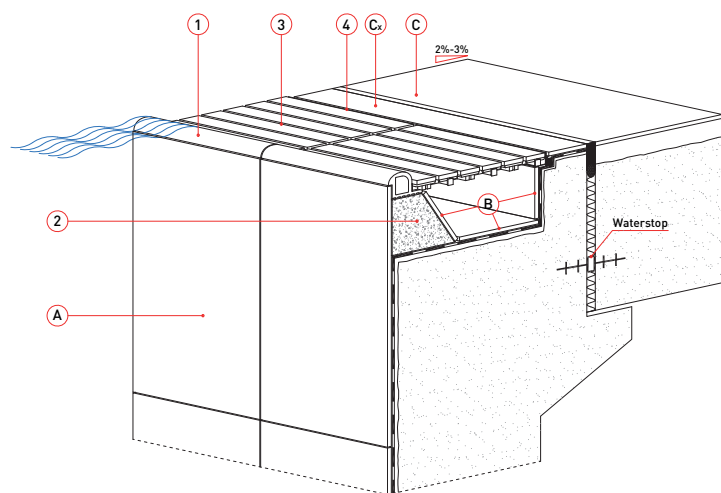

mod. WAMZ 001.2

- A** AMAZZONIA - Naturale_interno vasca / pool tank / interieur bassin / becken
- B** AMAZZONIA - Naturale_canaletta di ricircolo / overflow channel / caniveau eau bassin / rinne
- C** AMAZZONIA - Grip_esterno vasca / pool surround / plage / beckenumgang

x = Dimensione variabile dell'articolo, da tagliare in cantiere
Item with variable dimensions, to be cut on site
Dimensions de l'article variables, à couper sur le chantier
Variable Größe des Artikels, vor Ort zu schneiden

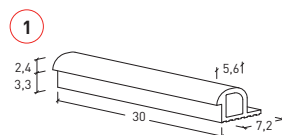

9860
Trim-Box

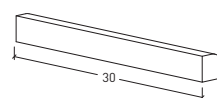

P 310-0296
Polyfill profilo / profile / profil / Profil*

* Vedi pagina: See page: Voir page: Siehe Seite: 42

AMAZZONIA

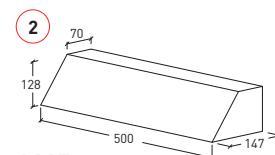

6415
Betonbuild

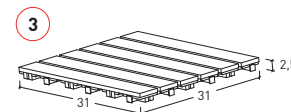

9842

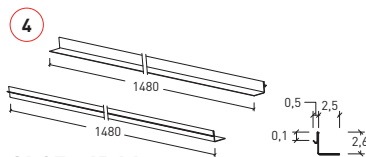

SL25 - IR16

Supporto griglia in acciaio inox / Stainless steel grating support / Support de grille inox / Rostträger aus Edelstahl

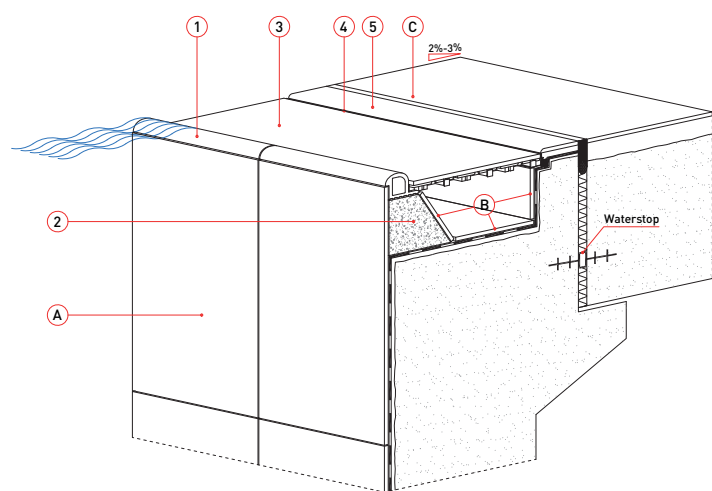

mod. WAMZ 001.3

- A** AMAZZONIA - Naturale_interno vasca / pool tank / interieur bassin / becken
- B** AMAZZONIA - Naturale_canaletta di ricircolo / overflow channel / caniveau eau bassin / rinne
- C** AMAZZONIA - Grip_esterno vasca / pool surround / plage / beckenumgang

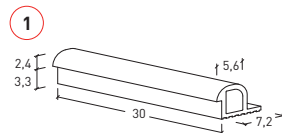

9860
Trim-Box

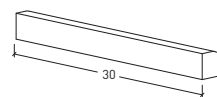

P 310-0296
Polyfill profilo / profile / profil / Profil*

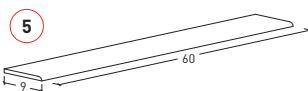

Bordo / Terminale Gradino B.C. 9x60

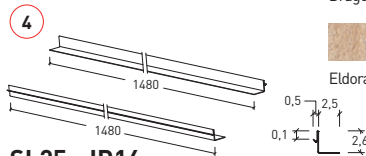

SL25 - IR16

Supporto griglia in acciaio inox / Stainless steel grating support / Support de grille inox / Rostträger aus Edelstahl

* Vedi pagina: See page: Voir page: Siehe Seite: 42

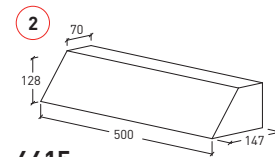

6415
Betonbuild

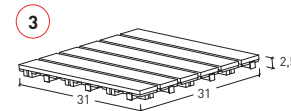

9842

AMAZZONIA



sistema wiesbaden / wiesbaden system / système wiesbaden / system wiesbaden

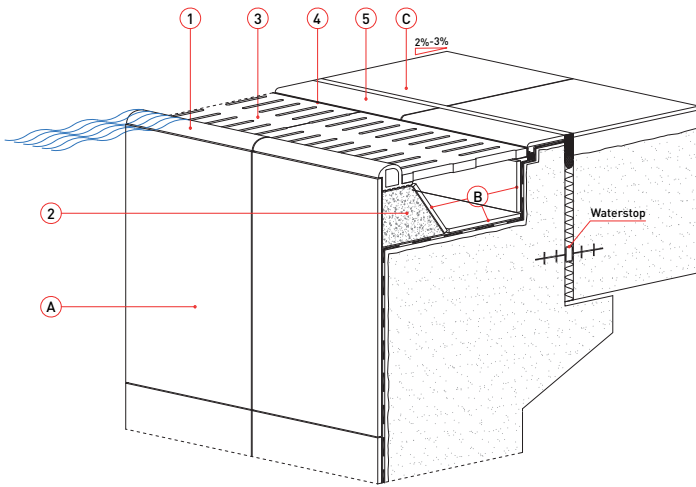

mod. WAMZ 001.1*

- A AMAZZONIA - Naturale_interno vasca / pool tank / interieur bassin / becken
- B AMAZZONIA - Naturale_canaletta di ricircolo / overflow channel / caniveau eau bassin / rinne
- C AMAZZONIA - Grip_esterno vasca / pool surround / plage / beckenumgang

* Consigliato solo per piscine private / Suggested for private pools only /
Conseillées seulement pour piscines privées / Nur für private Schwimmbäder

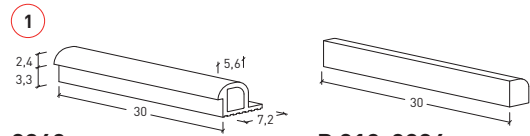

9860

Trim-Box

P 310-0296

Polyfill profilo / profile / profil / Profil*

* Vedi pagina: See page: Voir page: Siehe Seite: 42

AMAZZONIA

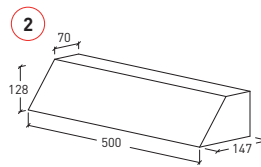

6415

Betonbuild

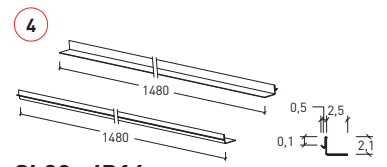

SL20 - IR16

Supporto griglia in acciaio inox
Stainless steel grating support
Support de grille inox
Rostträger aus Edelstahl

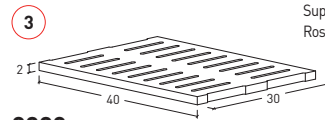

9883

AMAZZONIA - Grip

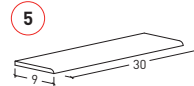

Bordo / Terminale Gradino B.C. 9x30

AMAZZONIA - Grip



AMAZZONIA

BORDO WIESABADEN A PARETE WIESBADEN POOL BORDER LOW-LEVEL TÊTE WIESBADEN EN PAROI BECKENKOPF WIESBADEN TIEFLIEGEND

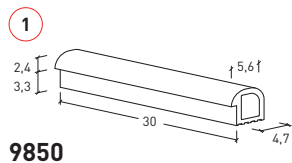
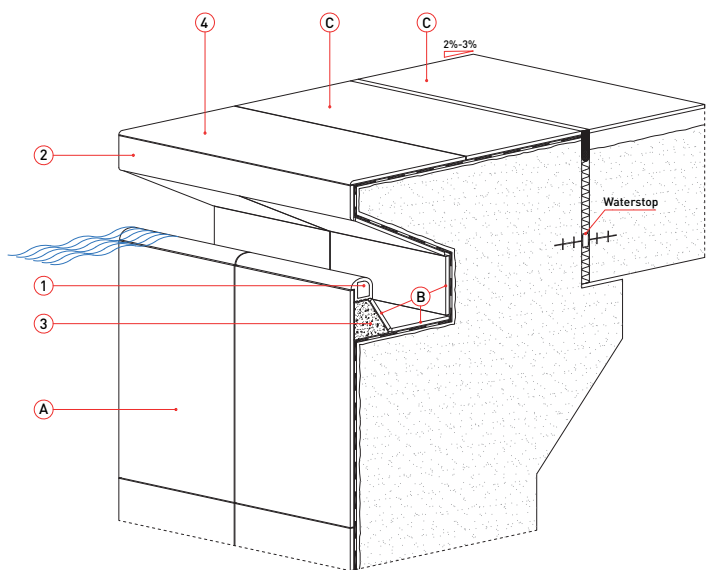

9850

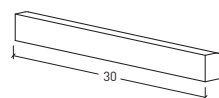

P 310-0296

Polyfill profilo / profile / profil / Profil*

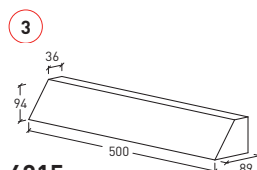

6315

Betonbuild

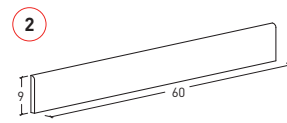

Battiscopa B.C. 9x60

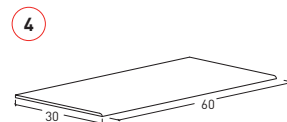

Gradino B.C. Grip 30x60 senza righe

AMAZZONIA



* Vedi pagina: See page: Voir page: Siehe Seite: 42

mod. WAMZ 005.1

- A AMAZONIA - Naturale_interno vasca / pool tank / interieur bassin / becken
- B AMAZONIA - Naturale_canaletta di ricircolo / overflow channel / caniveau eau bassin / rinne
- C AMAZONIA - Grip_esterno vasca / pool surround / plage / beckenumgang



sistema wiesbaden / wiesbaden system / système wiesbaden / system wiesbaden
 sistema a skimmer / skimmer system / système skimmers / system skimmer

Sistema a Skimmer

SKIMMER SYSTEM
 SYSTEME SKIMMERS
 SYSTEM SKIMMER

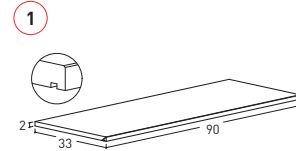
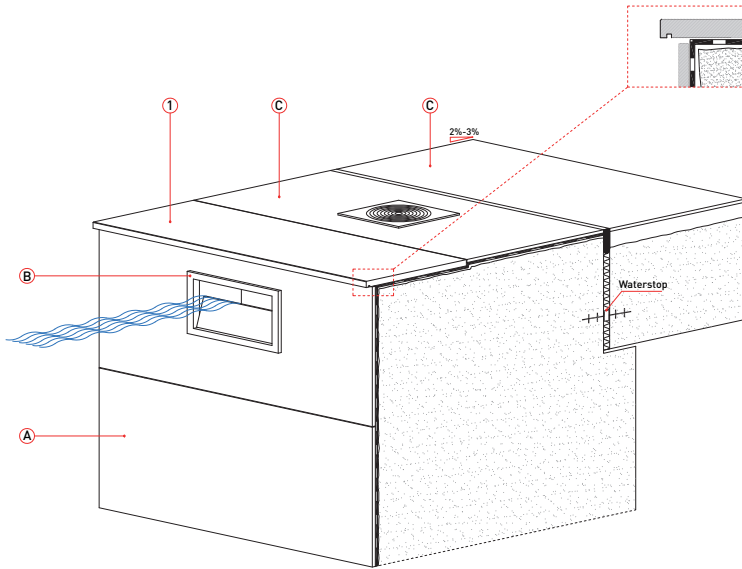

9560

AMAZZONIA - Grip



mod. SKAMZ 9560

- A AMAZZONIA - Naturale_interno vasca / pool tank / interieur bassin / becken
- B Skimmer
- C AMAZZONIA - Grip_esterno vasca / pool surround / plage / beckenumgang

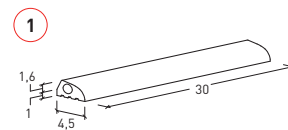
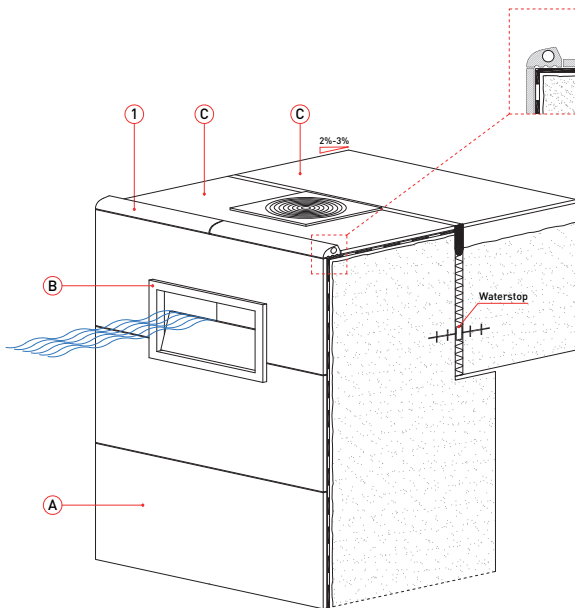

9840

Trim-Box

AMAZZONIA

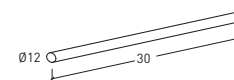
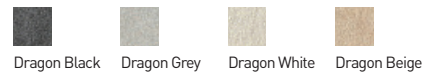

P 214-0296

Polyfill profilo / profile / profil / Profil*

* Vedi pagina: See page: Voir page: Siehe Seite: 42

mod. SKAMZ 9840

- A AMAZZONIA - Naturale_interno vasca / pool tank / interieur bassin / becken
- B Skimmer
- C AMAZZONIA - Grip_esterno vasca / pool surround / plage / beckenumgang

AMAZZONIA

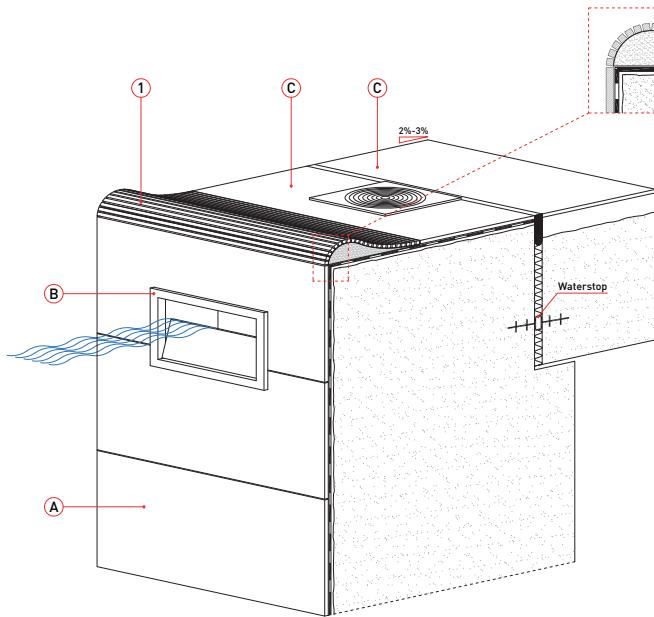

mod. SKAMZ 9660

- A AMAZZONIA - Naturale_interno vasca / pool tank / interieur bassin / becken
- B Skimmer
- C AMAZZONIA - Grip_esterno vasca / pool surround / plage / beckenumgang

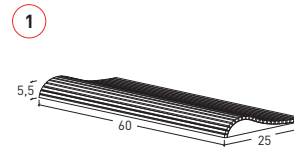

9660 - Pool Wave

AMAZZONIA - Grip

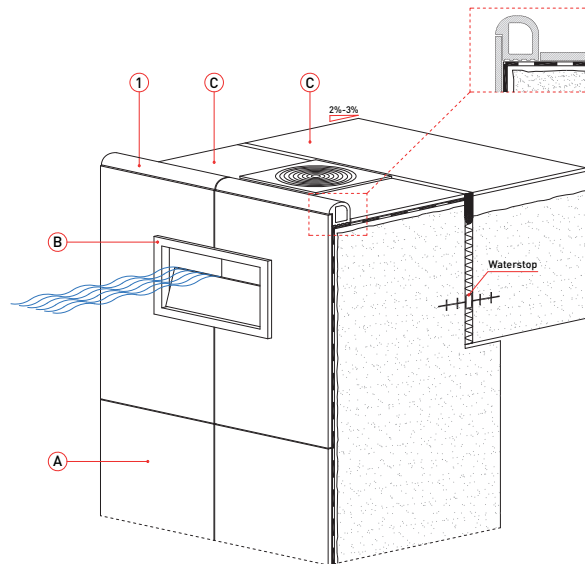

mod. SKAMZ 9850

- A AMAZZONIA - Naturale_interno vasca / pool tank / interieur bassin / becken
- B Skimmer
- C AMAZZONIA - Grip_esterno vasca / pool surround / plage / beckenumgang

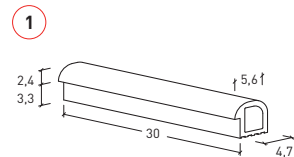

9850

AMAZZONIA

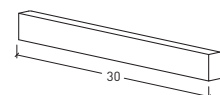

P 310-0296

Polyfill profilo / profile / profil / Profil*

* Vedi pagina: See page: Voir page: Siehe Seite: 42

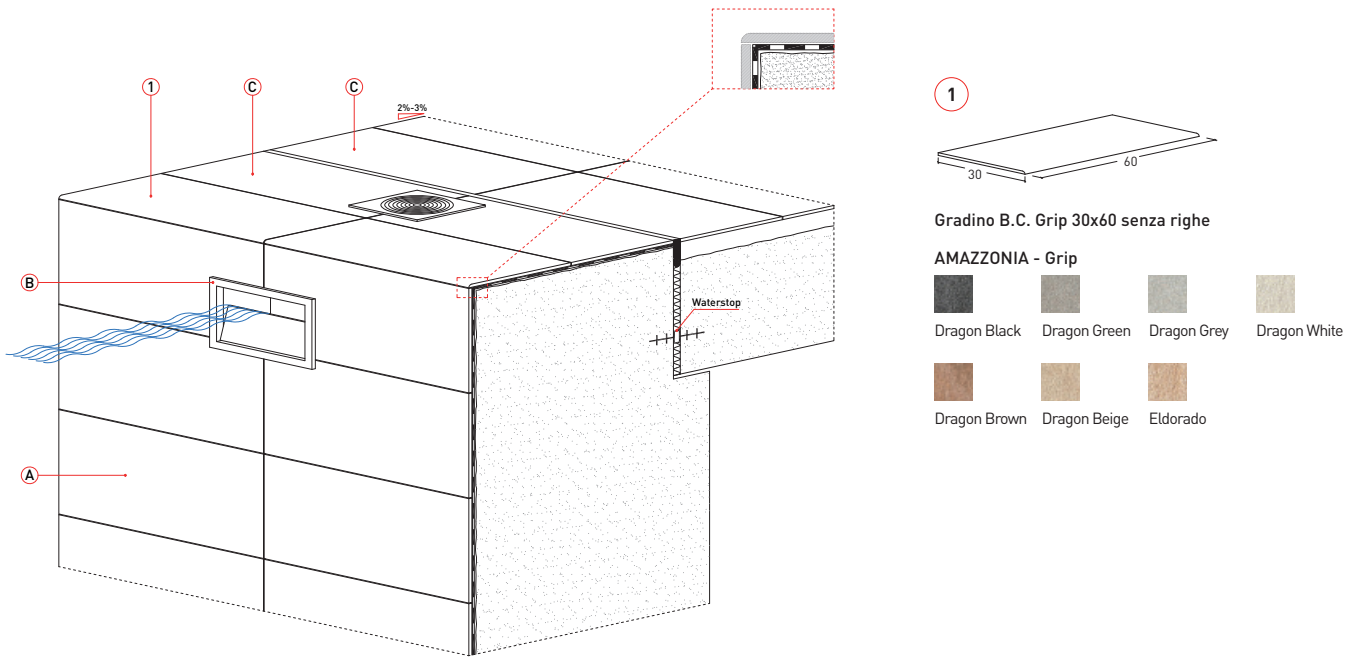

mod. SKAMZ GRADINO B.C. 30x60

- A AMAZZONIA - Naturale_interno vasca / pool tank / interieur bassin / becken
- B Skimmer
- C AMAZZONIA - Grip_esterno vasca / pool surround / plage / beckenumgang



Scale e gradini immersi in acqua

IMMERGED STAIRS AND STEPS
 ESCALIERS ET MARCHES IMMERGÉES DANS L'EAU
 TREPPEN UND STUFEN INS WASSER

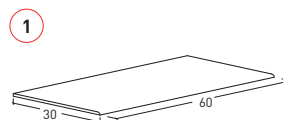
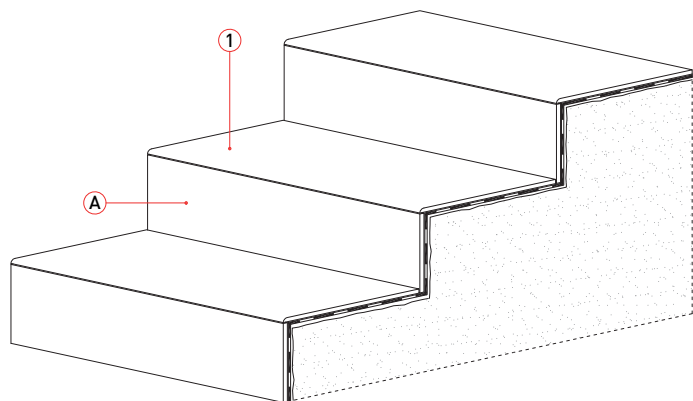

Gradino B.C. Grip 30x60 senza righe

AMAZZONIA - Grip



mod. SCAMZ 08

A AMAZONIA - Naturale
 alzata / tread riser / contrenarche / setz stufe

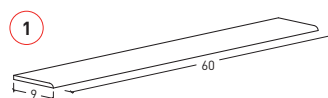
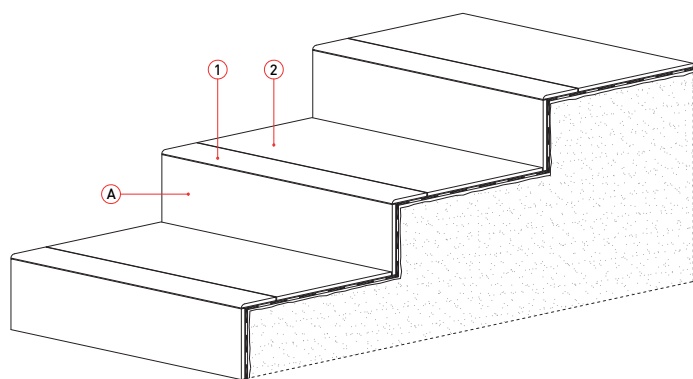

Bordo / Terminale Gradino B.C. 9x60

AMAZZONIA - Grip

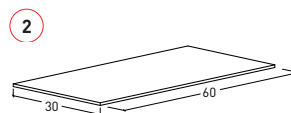

Amazzonia Grip 30x60

AMAZZONIA - Grip



scale e gradini immersi in acqua / immersed stairs and steps / escaliers et marches immergées dans l'eau /
treppen und stufen ins wasser

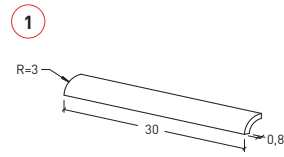
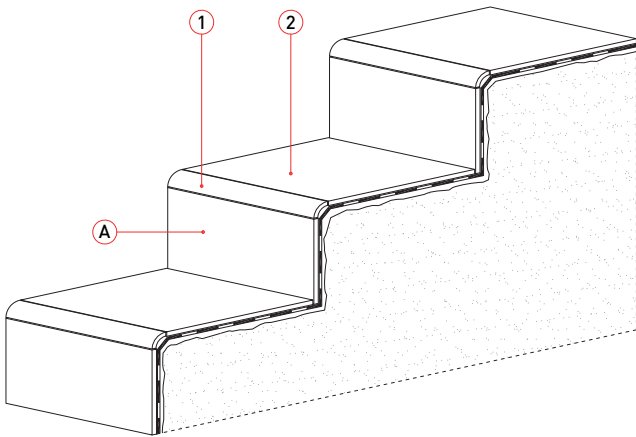

9835

AMAZZONIA - Grip



2

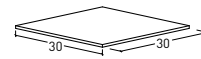

Amazzonia Grip 30x30

AMAZZONIA - Grip



mod. SCAMZ 03

A AMAZZONIA - Naturale
alzata / tread riser / contrenarche / setz stufe



Muretti di testata e muretti

HEADWALLS AND FENCES
 QUAIS DE DÉPART ET MURETS
 STIRNWÄNDE UND MAUERN

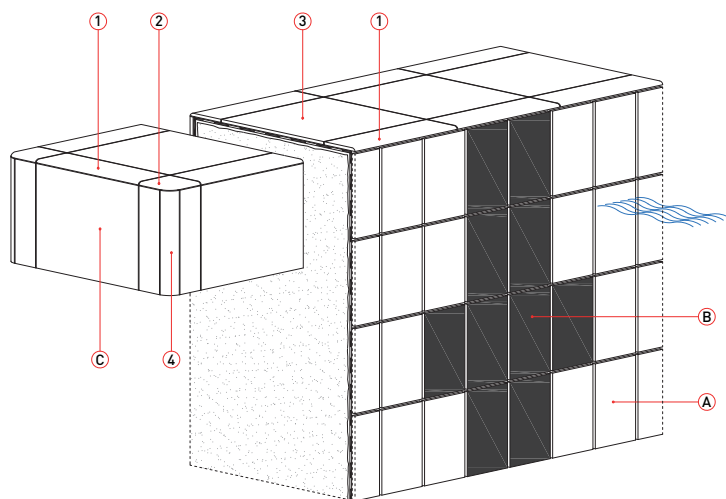

mod. QDAMZ 01

- A** LANDSCAPE - Friction_fascia di virata / turning area / zone de virage / wandflaeche
- B** LANDSCAPE - Friction_vie di corsa / marking lanes / ligne de nage / bahnamarkierungen
- C** AMAZZONIA - Naturale_rivestimento esterno / external wall / revetement exterieur / wandbekleidung

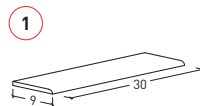

Bordo / Terminale Gradino B.C. 9x30

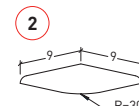

9900 Angolo Bordo / Terminale Gradino B.C. 9x9

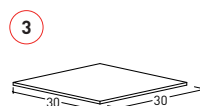

Amazonia Grip 30x30

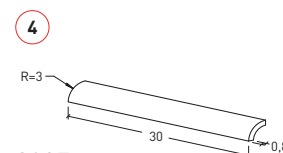

9835

AMAZZONIA - Grip

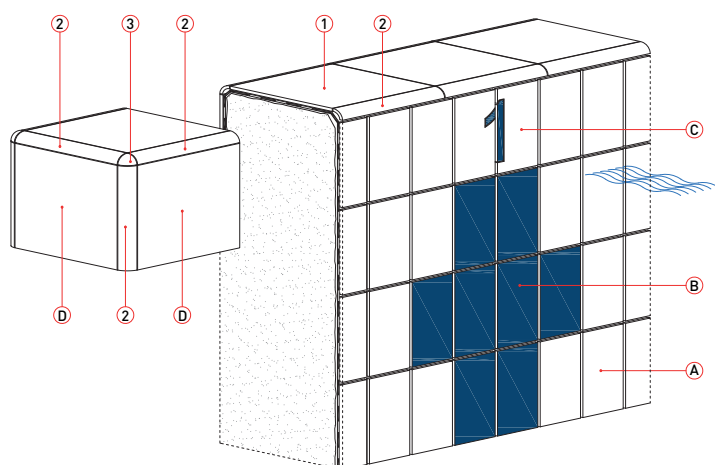

mod. QDAMZ 02

- A** LANDSCAPE - Friction_fascia di virata / turning area / zone de virage / wandflaeche
- B** LANDSCAPE - Friction_vie di corsa / marking lanes / ligne de nage / bahnamarkierungen
- C** piastrelle numerate / numbered tiles / carreau numerote / nummerierte platte
- D** AMAZZONIA - Naturale_rivestimento esterno / external wall / revetement exterieur / wandbekleidung

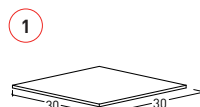

Amazonia Grip 30x30

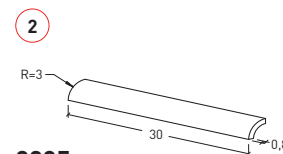

9835

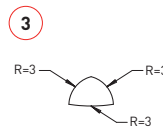

9837

AMAZZONIA - Grip



muretti di testata e muretti / headwalls and fences / quais de depart et murets / stirnwande und Mauern

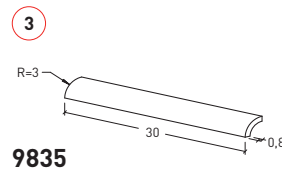
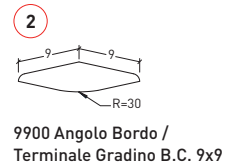
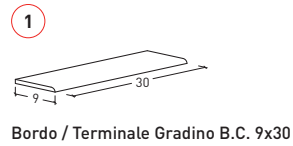
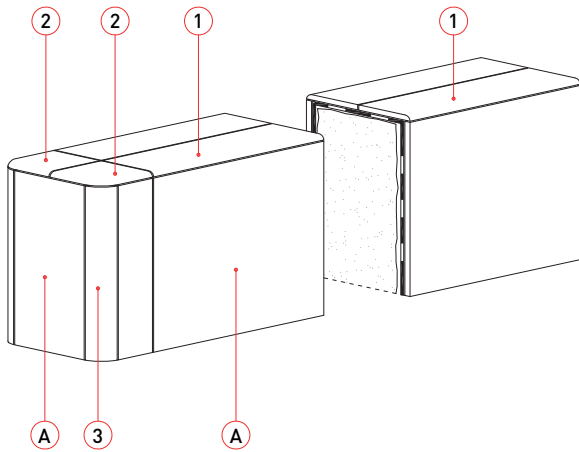

AMAZZONIA - Grip



mod. MUAMZ 01

A AMAZZONIA - Naturale_rivestimento / wall tiling / revetement / wandfliesen

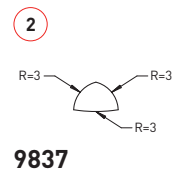
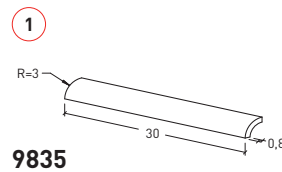
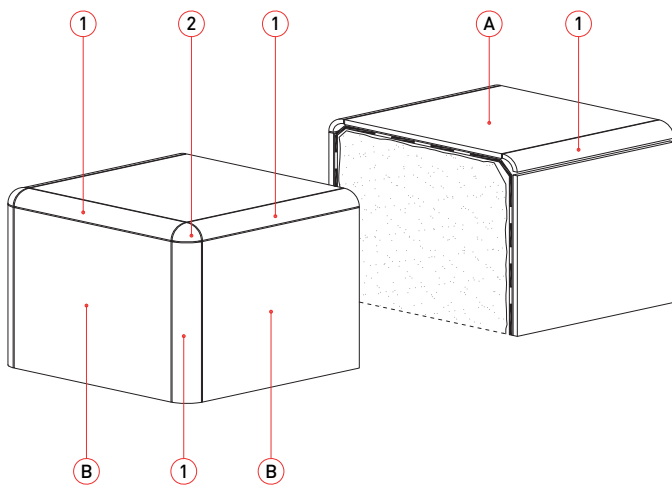

AMAZZONIA - Grip



mod. MUAMZ 02

A AMAZZONIA - Naturale/Grip_rivestimento / wall tiling / revetement / wandfliesen

B AMAZZONIA - Naturale_rivestimento / wall tiling / revetement / wandfliesen

Angoli e spigoli arrotondati

ROUNDED IN-CORNERS AND OUT-CORNERS
 ANGLES SORTANTS ET RENTRANTS ARRONDIS
 GERUNDETE KANTEN UND ECKEN

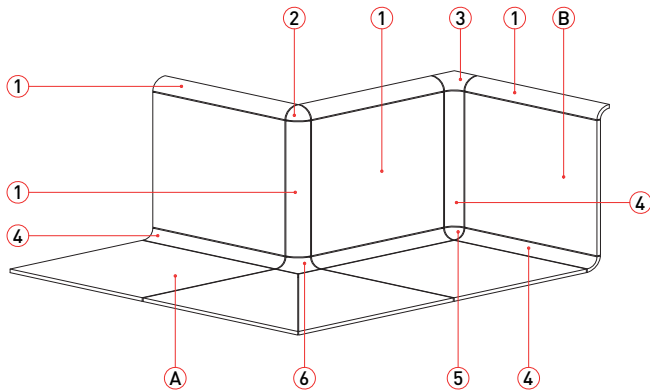

mod. FIAMZ 01

- A AMAZONIA Naturale/Grip_pavimento / floor / carrelage de sol / bodenfliesen
- B AMAZONIA Naturale_rivestimento / wall tiling / revetement / wandfliesen

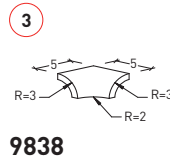
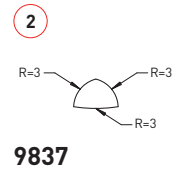
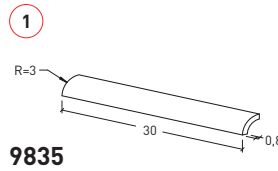

AMAZZONIA

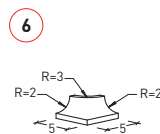
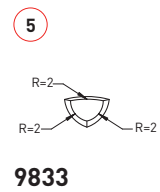
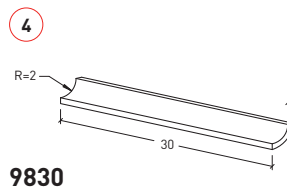

AMAZZONIA



angoli e spigoli arrotondati / rounded in-corners and out-corners / angles sortants et rentrants arrondis / gerundete Kanten und Ecken

vasche lavapiedi / feet washers / pédiluves / durchschreitbecken

Vasche lavapiedi

FEET WASHERS
PÉDILUVES
DURCHSCHREITBECKEN

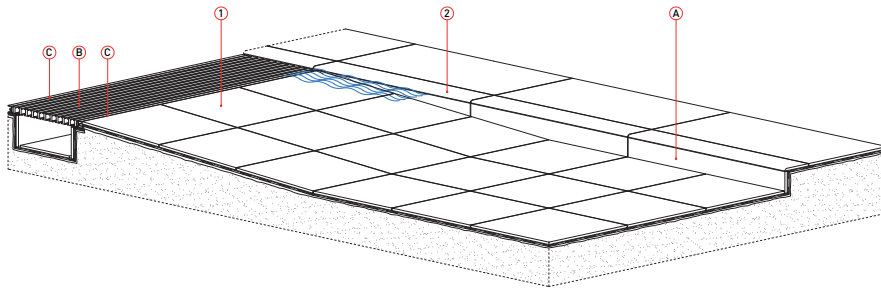

1

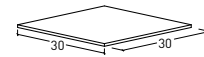

Amazzonia Grip 30x30

2

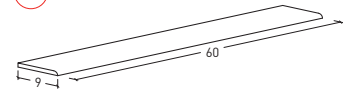

Bordo / Terminale Gradino B.C. 9x60

mod. PEAMZ 01

- A AMAZZONIA - Naturale_rivestimento / wall tiling / revêtement / wandfliesen
- B PADANA GRID_griglia in pvc / grating in pvc / grille en pvc / pvc rost
- C PADANA GRID_angolare in pvc / pvc grating support / corniere en pvc / pvc rost traeger

AMAZZONIA - Grip

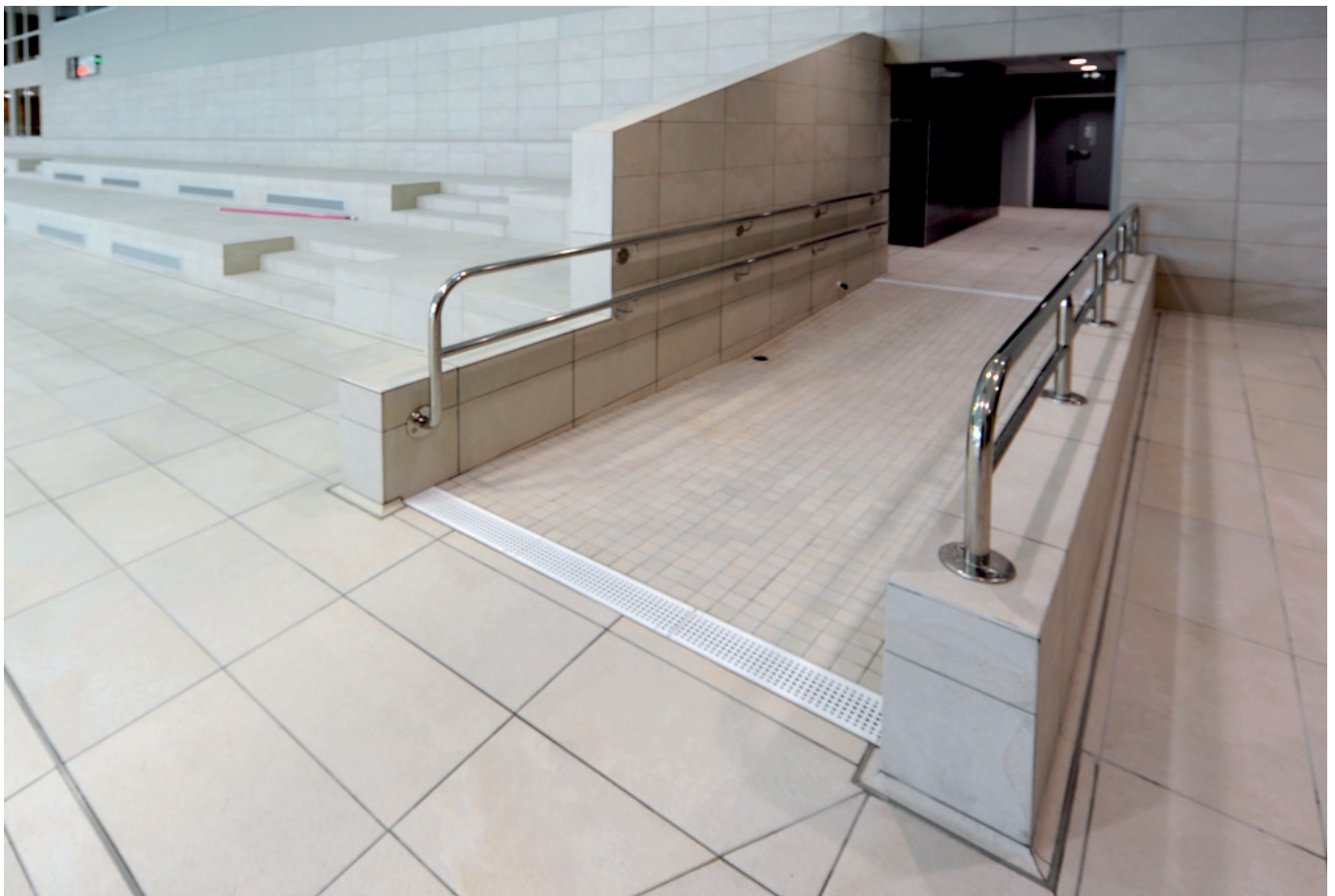
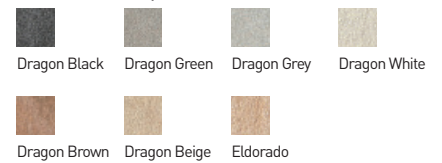

Newood

GRANITOKER

Newood rappresenta tutta l'armonia estetica del legno e la piacevolezza di un contatto morbido e materico unita a eccellenti prestazioni di praticità e durevolezza.

I formati, in lastre o a listoni, i decori ed i pezzi speciali permettono di creare composizioni sempre originali per centri benessere, aree wellness, piscine private e di hotels con l'ispirazione alla naturalezza del design nordico.

Otto colori che rimandano alle tonalità classiche dei legni pregiati e ai cromatismi più contemporanei dei grigi, sono ideali per creare ambienti d'acqua dall'atmosfera intima e rilassante.

Le due finiture superficiali, Naturale (R10-B), e Outdoor (R11-C) rendono questo prodotto indicato per pavimenti sia asciutti che bagnati e per rivestimenti senza soluzione di continuità.

Newood embodies the aesthetic harmony of wood and the pleasure of its soft and textured feel combined with excellent technical features and durability.

The sizes of the slabs and planks, the decorations and available fittings are ideal to create ever-new combinations for spas, wellness areas, private and public swimming pools inspired by the natural feel of nordic design.

The colour range consists of six colours with the traditional shades of valuable wood and two modern grey and black shades are perfect to add an intimate, relaxing touch to any pool.

The two surface finishes, Naturale rated non-slip R10-B and Outdoor rated non-slip R11-C, make this product ideal for wet and dry floors or for wall tilings.

Newood représente l'harmonie esthétique du bois et l'agrément d'un contact souple et matériel qui se combine avec des performances excellentes en termes de praticité et durabilité.

Les formats, en dalles ou planches, les décorations et les pièces spéciales permettent de créer des compositions toujours originales pour spas, centres de bien-être, piscines particulières et hôtelières s'inspirant du caractère naturel du design nordique.

Les huit couleurs renvoyant aux tons classiques des bois précieux et aux chromatismes plus contemporains des gris, sont idéales pour créer des environnements d'eau avec ambiance intime et relaxante.

Les deux finitions de surface, Naturale classée R10-B et Outdoor, classée R11-C selon la norme DIN, rendent ce produit très approprié pour des sols secs et mouillés, ainsi que pour des revêtements muraux.

Newood verkörpert in vollem Ausmaß die Holzoptik und den angenehm weichen und materischen Kontakt und bietet zugleich ausgezeichnete praktische Leistungen und Dauerhaftigkeit.

Mit den Formaten in Platten oder Leisten, den Dekoren und Formstücken können immer originell wirkende Kombination für Wellness-Center, Hotels und privaten Schwimmbäder gestaltet werden, die sich an der natürlichen Wirkung nordischer Designs inspirieren.

Acht Farben, die an die klassischen Farbtöne der edlen Hölzer und an die modernsten Grautöne erinnern, sind ideal für Bereiche mit Wasser in einer intimen und entspannenden Atmosphäre.

Durch die beiden Oberflächenausführungen Naturale (R10-B) und Outdoor (R11-C) ist dieses Produkt sowohl für trockene wie auch nasse Böden und für unterbrechungslose Verkleidungen geeignet.



naturale

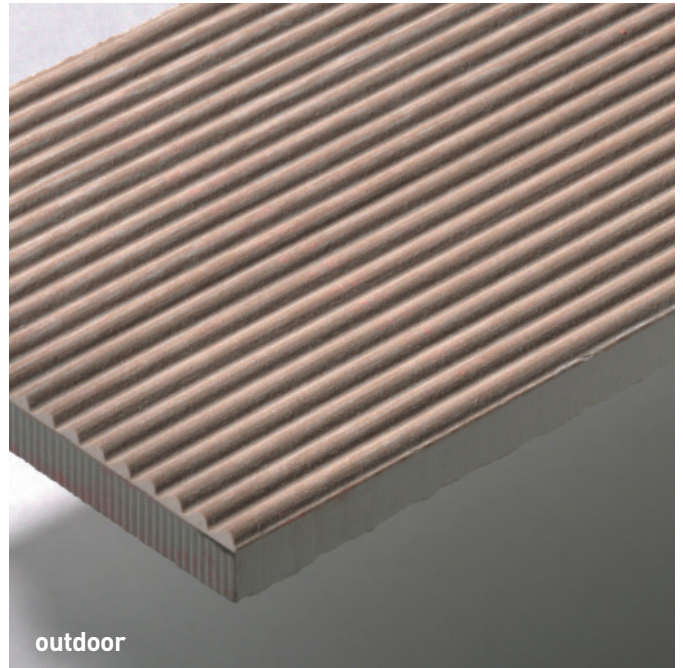

outdoor

Formati Sizes Formats Formate	cm 11x90 4 ³ / ₈ " x 35 ³ / ₈ "	cm 15x90 5 ⁷ / ₈ " x 35 ³ / ₈ "	cm 22,5x90 8 ⁷ / ₈ " x 35 ³ / ₈ "	cm 45x90 17 ³ / ₄ " x 35 ³ / ₈ "	cm 15x120 5 ⁷ / ₈ " x 47 ¹ / ₄ "	cm 20x120 7 ⁷ / ₈ " x 47 ¹ / ₄ "	cm 60x120 23 ⁵ / ₈ " x 47 ¹ / ₄ "
Superfici Surfaces Surfaces Oberflächen	● ●**	●	●	●	● ●**	● ●**	● ●**
	mm 9	mm 9	mm 9	mm 9	mm 9	mm 9 mm 9*▲	mm 9

● Naturale ⁽¹⁾

DIN 51097 B	XP P 05-010 PN 18	
DIN 51130 R 10	XP P 05-010 PC 10	

● Outdoor ⁽²⁾

DIN 51097 C	XP P 05-010 PN 24	
DIN 51130 R 11	XP P 05-010 PC 20	

Rettificate in un unico calibro Rectified version in a single calibrer Rectifiés en un unique calibre Boden Sie in einem einzigen Kaliber

* Non rettificato Unrectified Non rectifié Nicht kalibriert

** Superficie Outdoor disponibile solo nei colori: Outdoor Surface available only in the colours: Surface Outdoor disponible uniquement dans les couleurs: Oberfläche Outdoor Verfügbar nur in den folgenden Farben: **Brown, Cream, Grey, Wengé**

▲ Solo nei colori: Only in the colours: Seulement dans les couleurs: Nur in die Farben: **Beige, Brown, Ivory, White**

⁽¹⁾ A pavimento: zone asciutte Floor: dry zones Revêtement de sol : zones sèches Boden: trockenzone

⁽²⁾ A pavimento: zone asciutte e zone umide Floor: dry zones and wet zones Revêtement de sol : zones sèches et zones humides Boden: trockenzone und feuchtenzone

NEWOOD

Newood Black

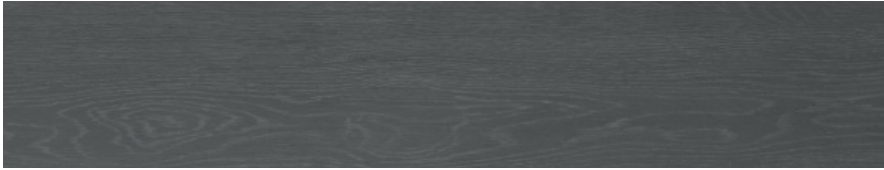

Newood Grey



Newood White



Newood Wengé

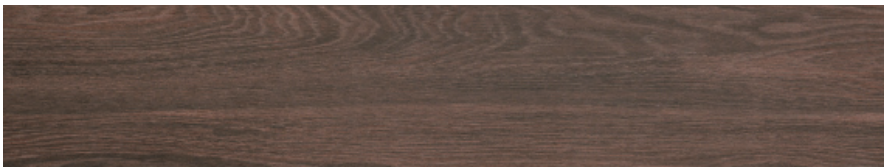

Newood Brown

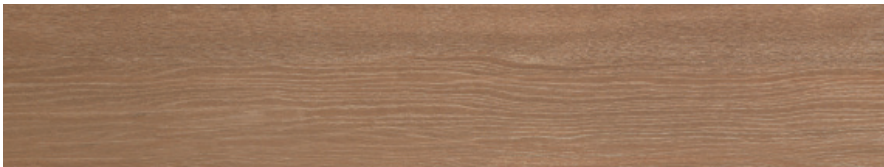

Newood Cream

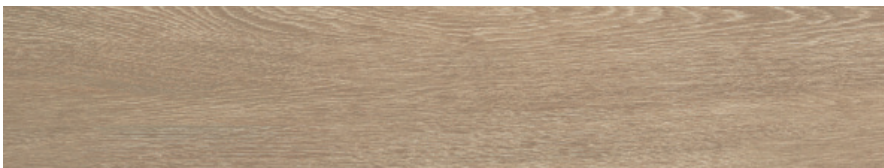

Newood Beige

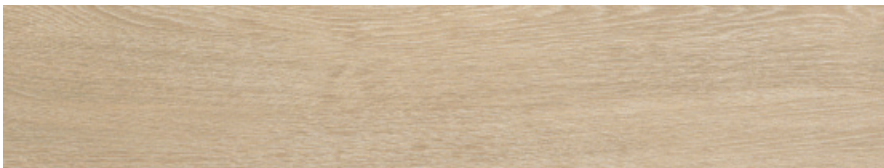

Newood Ivory

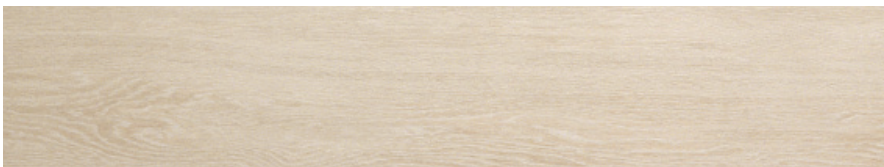

Media
Medium
Modérée
Mittlere

Vedi pagina: See page: Voir page: Siehe Seite: **237**



NEWOOD

TERMINALI GRADINO OUTDOOR (R11-C) BULLNOSES OUTDOOR (R11-C) NEZ DE MARCHE OUTDOOR (R11-C) RIEMCHEN FÜR TREPPENPLATTEN OUTDOOR (R11-C)

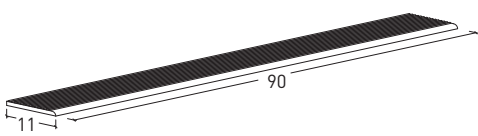

Bordo / Terminale Gradino B.C. 11x90 Outdoor

9 pc/box 2,5 kg/pc

NEWOOD

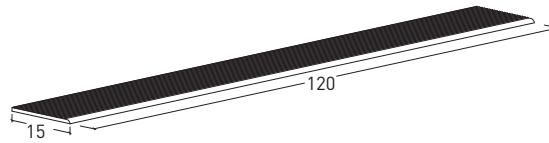

Bordo / Terminale Gradino B.C. 15x120 Outdoor

5 pc/box 4,3 kg/pc

NEWOOD



BATTISCOPIA SKIRTING BORD ARRONDI SOCKEL

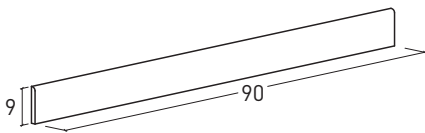

Battiscopa B.C. 9x90

9 pc/box 1,89 kg/pc

NEWOOD

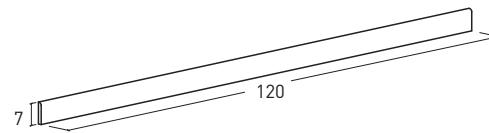

Battiscopa B.C. 7x120

8 pc/box 1,21 kg/pc

NEWOOD

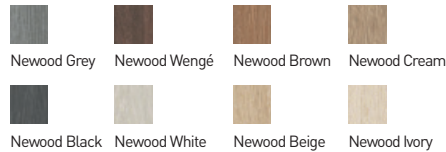

BORDO VASCA WIESBADEN A PAVIMENTO POOL BORDER WIESBADEN HIGH-LEVEL TÊTE DE BASSIN WIESBADEN SURFLOT BECKENKOPF WIESBADEN HOCHLIEGEND

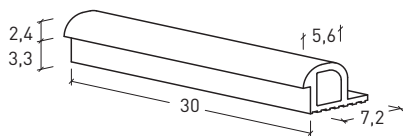

Trim-Box

9860

8 pc/box 0,96 kg/pc

NEWOOD

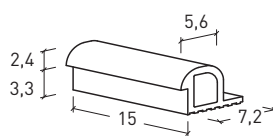

Trim-Box

9862

16 pc/box 0,48 kg/pc

NEWOOD

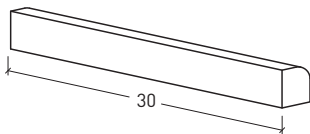

P 310-0296

Polyfill profilo / profile / profil / Profil*

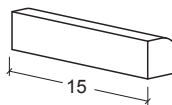

P 311-0147

Polyfill profilo / profile / profil / Profil*

* Vedi pagina: See page: Voir page: Siehe Seite: 42

SUPPORTO BETONBUILD CEMENTITIUS SUPPORT BETONBUILD SUPPORT EN BETON BETONBUILD TRÄGERELEMENT BETONBUILD

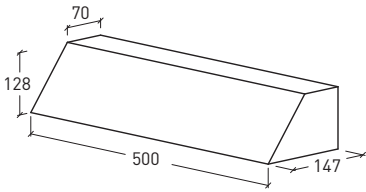

6415
Betonbuild 16,00 kg/pc 2 pc/ml

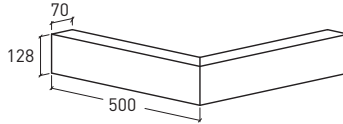

6417
Betonbuild 2 pc 45° 32,00 kg/pc

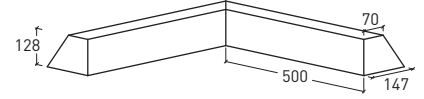

6418
Betonbuild 2 pc 45° 32,00 kg/pc

BORDO VASCA WIESBADEN A PARETE POOL BORDER WIESBADEN LOW-LEVEL TÊTE DE BASSIN WIESBADEN EN PAROI BECKENKOPF WIESBADEN TIEFLIEGEND

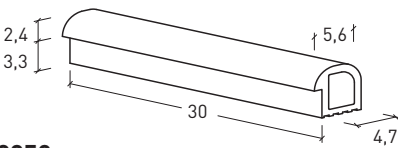

9850
8 pc/box 0,8 kg/pc

NEWOOD

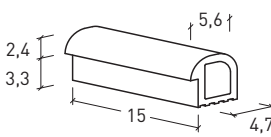

9852
16 pc/box 0,4 kg/pc

NEWOOD

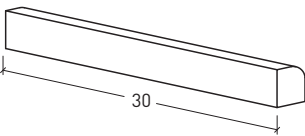

P 310-0296
Polyfill profilo / profile / profil / Profil*

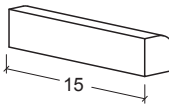

P 311-0147
Polyfill profilo / profile / profil / Profil*

* Vedi pagina: See page: Voir page: Siehe Seite: 42

SUPPORTO BETONBUILD CEMENTITIUS SUPPORT BETONBUILD SUPPORT EN BETON BETONBUILD TRÄGERELEMENT BETONBUILD

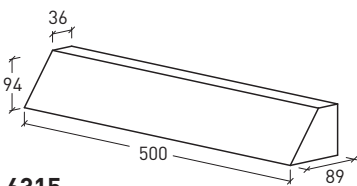

6315
Betonbuild 12,00 kg/pc 2 pc/ml

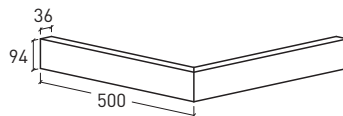

6317
Betonbuild 2 pc 45° 24,00 kg/pc

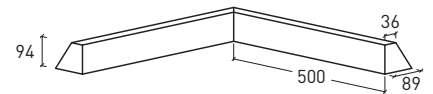

6318
Betonbuild 2 pc 45° 24,00 kg/pc

BORDO VASCA SKIMMER SKIMMER POOL BORDER TÊTE DE BASIN SKIMMER BECKENKOPF SKIMMER

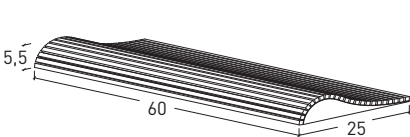

9660 - Pool Wave
1 pc/box 10,0 kg/pc

NEWOOD

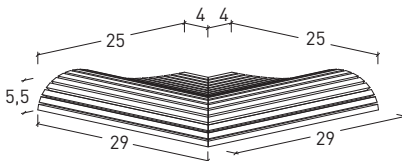
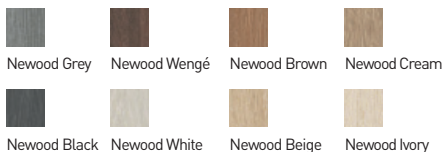

9667 - Pool Wave
2 pc 45° 1+1 pc/box 9,8 kg/pc

NEWOOD

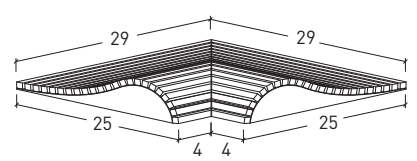
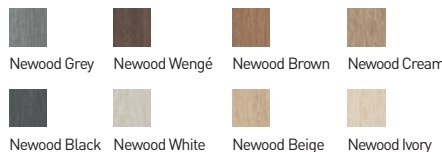

9668 - Pool Wave
2 pc 45° 1+1 pc/box 9,8 kg/pc

NEWOOD



NEWOOD

GRIGLIE IN CERAMICA PARALLELE PARALLEL CERAMIC GRATINGS GRILLES CÉRAMIQUES PARALLELES PARALLELE ROSTE AUS KERAMIK

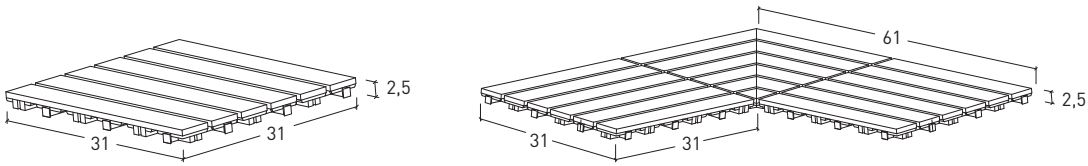

9842 ⁽¹⁾

6 pc/box 2,3 kg/pc

NEWOOD



9843 ⁽¹⁾

2+2 pc/box 7,9 kg/pc

NEWOOD

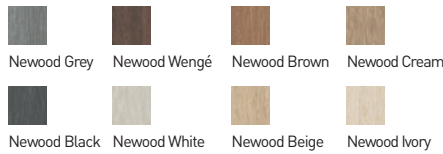

SUPPORTI GRIGLIA GRATING SUPPORTS SUPPORTS DE GRILLE ROSTAUFLAGER

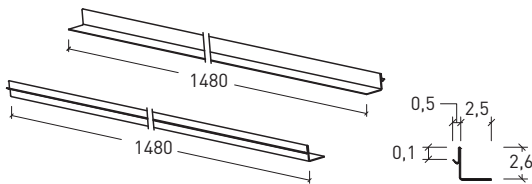

SL25 - IR16*

Supporto griglia in acciaio inox
Stainless steel grating support
Support de grille inox
Rostträger aus Edelstahl

* Articoli realizzati con acciaio inox AISI 316L-BA - EN 1.4404 (Lucido) / Classe di corrosività C4
Items made with stainless steel AISI 316L-BA - EN 1.4404 (Polished) / Corrosion Class C4
References fabriquées en acier inox AISI 316L-BA - EN 1.4404 (Poli) / Catégorie de corrosivité C4
Artikeln aus Edelstahl AISI 316L-BA - EN 1.4404 (Glanzend) / Korrosionsklasse C4

⁽¹⁾ Idoneità e geometria della griglia da verificare con i professionisti incaricati della progettazione della piscina e dei relativi impianti. Fuga tra griglia e supporto circa 7 mm. Fuga tra ciascun elemento posato circa 3 mm / Adequacy and geometry of the grating to be approved by the specialists in charge of the designing of the pool and of the related equipment. Joint between grating and screed approx. 7 mm. Joint between each element laid approx 3 mm / Adéquation et géométrie de la grille à bien vérifier par les responsables de la conception de la piscine et des installations associées. Joint entre grille et support d'environ 7 mm. Joint entre chaque élément posé environ 3 mm / Eignung und Geometrie des Gitters sind mit den Fachleuten zu überprüfen, die für die Gestaltung des Pools und seiner Systeme verantwortlich sind. Fuge zwischen Gitter und Stütze ca. 7 mm. Fuge zwischen jedem verlegten Element ca. 3 mm

pezzi speciali / fittings / pièces spéciales / formstücke
 sistema finlandese / finnish system / système finlandais / system finland

Sistema Finlandese

FINNISH SYSTEM
 SYSTEME FINLANDAIS
 SYSTEM FINNLAND

BORDI FINLANDESE SENZA AGGRAPPO FINNISH POOL BORDERS WITHOUT FINGER GRIP TÊTES FINLANDAISES SANS ACCROCHE DOIGTS
 BECKENKÖPFEN FINNLAND OHNE HANDFASS

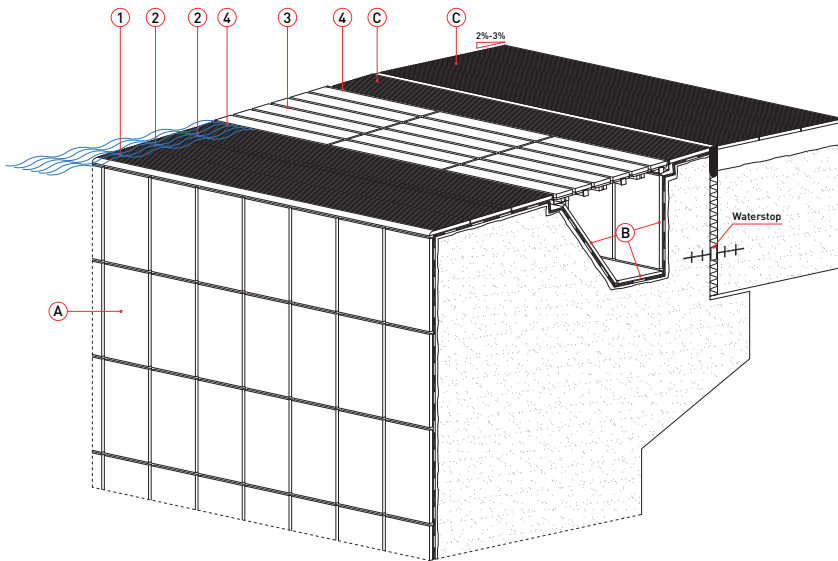

mod. FNWD 002.3

- A** LANDSCAPE - Satin_interno vasca / pool tank / interieur bassin / becken
- B** LANDSCAPE - Satin_canaletta di ricircolo / overflow channel / caniveau eau bassin / rinne
- C** NEWOOD - Outdoor_esterno vasca / pool surround / plage / beckenumgang

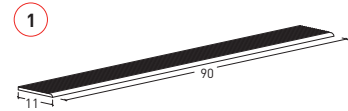

Bordo / Terminale Gradino B.C. 11x90 Outdoor

NEWOOD

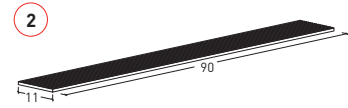

Newood 11x90 Outdoor

NEWOOD

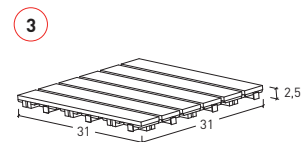

9842

NEWOOD

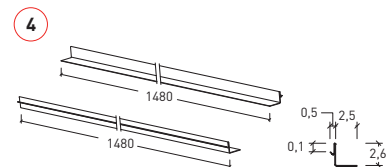

SL25 - IR16

Supporto griglia in acciaio inox
 Stainless steel grating support
 Support de grille inox
 Rostträger aus Edelstahl

Sistema Wiesbaden

WIESBADEN SYSTEM
 SYSTEME WIESBADEN
 SYSTEM WIESBADEN

BORDI WIESBADEN A PAVIMENTO WIESBADEN POOL BORDERS HIGH-LEVEL TÊTES WIESBADEN SURFLOT BECKENKÖPFEN WIESBADEN HOCHLIEGEND

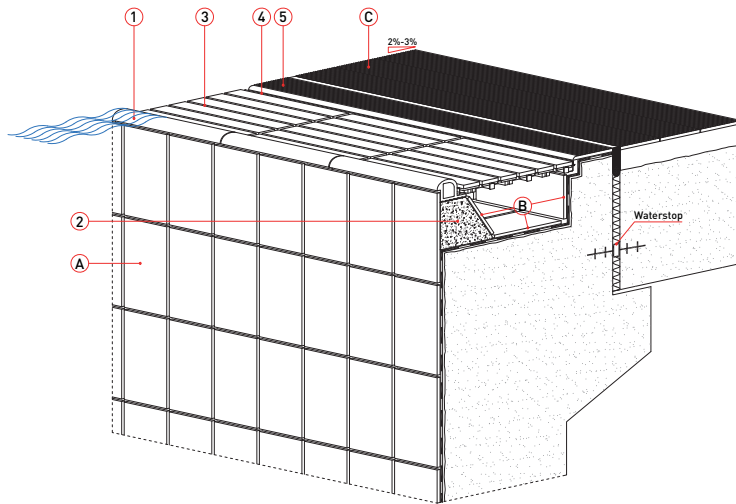

mod. WNWD 001.4

- A** LANDSCAPE - Satin_interno vasca / pool tank / interieur bassin / becken
- B** LANDSCAPE - Satin_canaletta di ricircolo / overflow channel / caniveau eau bassin / rinne
- C** NEWOOD - Outdoor_esterno vasca / pool surround / plage / beckenumgang

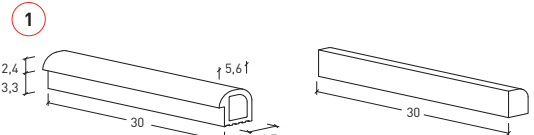

9850 **P 310-0296**
 Polyfill **profilo / profile / profil / Profil***

NEWOOD

Newood Grey	Newood Wengé	Newood Brown	Newood Cream

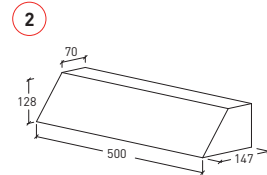

6415
 Betonbuild

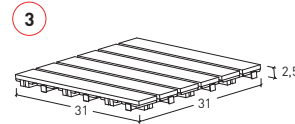

9842

NEWOOD

Newood Grey	Newood Wengé	Newood Brown	Newood Cream
Newood Black	Newood White	Newood Beige	Newood Ivory

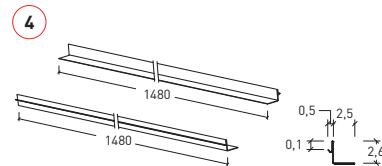

SL25 - IR16
 Supporto griglia in acciaio inox / Stainless steel grating support /
 Support de grille inox / Rosträger aus Edelstahl

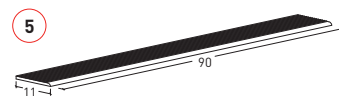

Bordo / Terminale Gradino B.C. 11x90 Outdoor

NEWOOD

Newood Grey	Newood Wengé	Newood Brown	Newood Cream

* Vedi pagina: See page: Voir page: Siehe Seite: 42

sistema wiesbaden / wiesbaden system / système wiesbaden / system wiesbaden
 sistema a skimmer / skimmer system / systeme skimmers / system skimmer

Sistema a Skimmer

SKIMMER SYSTEM
 SYSTEME SKIMMERS
 SYSTEM SKIMMER

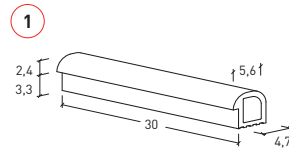
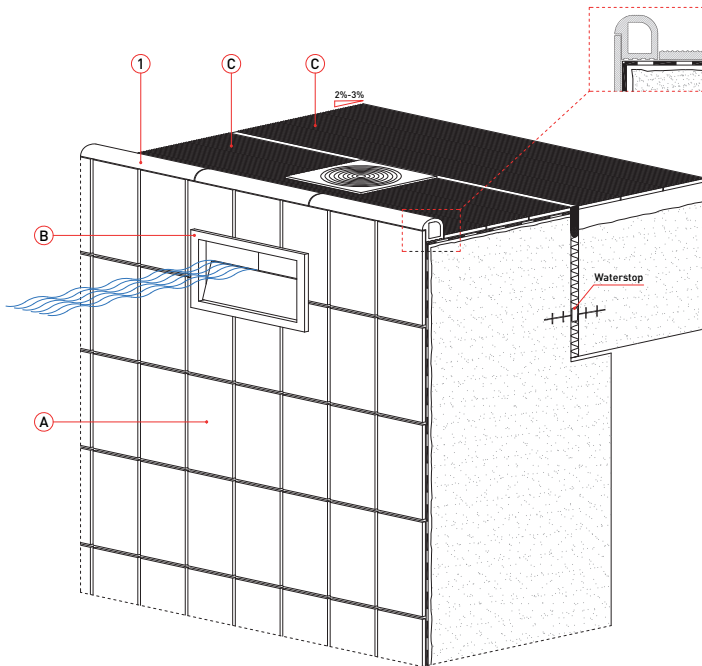

9850

NEWOOD

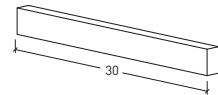

P 310-0296

Polyfill profilo / profile / profil / Profil*

* Vedi pagina: See page: Voir page: Siehe Seite: 42

mod. SKNWD 9850

- A LANDSCAPE - Satin_Interno vasca / pool tank / interieur bassin / becken
- B Skimmer
- C NEWOOD - Outdoor_esterno vasca / pool surround / plage / beckenumgang

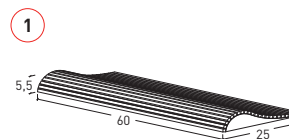
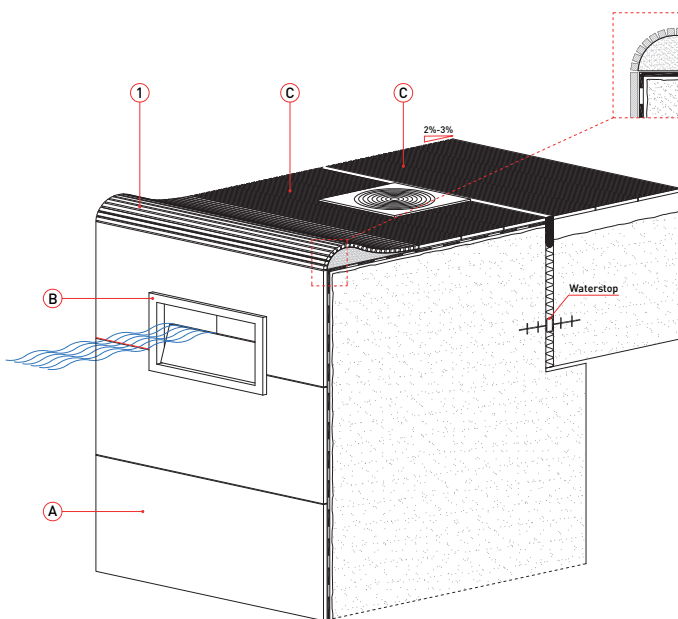

9660 - Pool Wave

NEWOOD



mod. SKNWD 9660

- A Interno vasca / pool tank / interieur bassin / becken
- B Skimmer
- C NEWOOD - Outdoor_esterno vasca / pool surround / plage / beckenumgang

Country Wood

GRANITOKER

Una superficie ceramica effetto legno dall'estetica originale che ci parla del tempo e del suo passaggio: l'aspetto leggermente vissuto percorre gli interni regalando ad ogni spazio un fascino antico, bilanciandosi in modo armonico con arredi moderni, secondo un mood ricercato e contemporaneo.

Tutti i colori sono disponibili nei formati 60x120 cm, 20x120 cm, 25x151 cm. Per le pavimentazioni esterne tutti i colori sono inoltre disponibili nel formato 40x120 cm con spessore 20 mm prodotto unicamente con superficie Grip (R11-B) per permettere di dare continuità estetica con gli interni.

Country wood riflette la bellezza originale del legno con una gamma colori calibrata e naturale, trasformandosi in una superficie versatile adatta anche per l'esterno, in cui passato e presente si fondono e si rinnovano per restituire atmosfere calde e avvolgenti.

These wood-effect ceramic tiles make for an original aesthetic effect that celebrates the passing of time. The slightly worn look of the tiles lends a sense of age-old charm to any space, striking the perfect balance with modern furniture to create a sophisticated, contemporary vibe.

All colors are manufactured in sizes 60x120 cm, 20x120 cm, 25x151 cm. For external floorings all colors are also produced in size 40x120 cm - 20 mm thickness with surface Grip (R11-B) to offer the possibility of aesthetical continuity with indoors.

Country Wood combines the original beauty of wood with a carefully planned, natural colour palette to create a versatile surface perfect for both indoor and outdoor. The collection takes the best of the past and present to produce something completely new and create a warm, inviting atmosphere.

Country Wood présente une surface effet bois et à l'esthétique originale qui raconte le temps et son passage : l'aspect légèrement vécu donne à chaque espace un charme ancien, équilibré et en harmonie avec un décor moderne, dans un style aussi raffiné que contemporain.

Toutes les teintes sont fabriquées dans les formats 60x120 cm, 20x120 cm, 25x151 cm. Pour l'extérieur toutes les couleurs sont fabriquées aussi dans le format 40x120 cm avec épaisseur 20 mm dans la finition Grip (R11-B) pour offrir une continuité esthétique avec l'intérieur.

Country Wood reflète la beauté originelle du bois avec une gamme de couleurs calibrée et naturelle, sous la forme d'une surface polyvalente, où passé et présent se fondent et se renouvellent pour exprimer une atmosphère chaude et accueillante. que pour revêtements muraux.

Country Wood ist eine an Holz erinnernde Keramikoberfläche mit origineller Ästhetik, die uns von der Zeit und dem Vergehen der Zeit erzählt: Der Effekt der leichten Abnutzung verleiht jedem Raum einen antiken Charme, der sich harmonisch mit modernen Möbeln in einer raffinierten und zeitgemäßen Atmosphäre vereint.

Alle Farben sind im Formaten 60x120, 20x120 und 25x151 cm vorrätig. Für Außenbereichen sind alle Farben auch im Format 40x120 cm - 20 mm Stärke mit Oberfläche Grip (R11-B) hergestellt um die ästhetische Kontinuität mit Innenbereichen zu gewährleisten.

Country Wood spiegelt die ursprüngliche Schönheit des Holzes auch in der ausgewogenen und natürlichen Farbpalette wieder und verwandelt sich in eine vielseitige Oberfläche, bei der sich Vergangenheit und Gegenwart vereinen und erneuern, um warme und einladende Räumlichkeiten zu gestalten. Verkleidungen geeignet.



Formati Sizes Formats Formate	cm 20x120 7 ⁷ / ₈ "x47 ¹ / ₄ "	cm 40x120 15 ³ / ₄ "x47 ¹ / ₄ "	cm 60x120 23 ⁵ / ₈ "x47 ¹ / ₄ "	cm 25x151 9 ⁷ / ₈ "x59 ¹ / ₂ "
Superfici Surfaces Surfaces Oberflächen	● ●	●	● ●	● ●
	mm 9	mm 20	mm 9	mm 10

● Naturale ^[1]

DIN 51130 R 10 XP P 05-010 PC 10



● Grip ^[2]

DIN 51097 B XP P 05-010 PN 18



DIN 51130 R 11 XP P 05-010 PC 20



Rettificate in un unico calibro Rectified version in a single caliber Rectifiés en un unique calibre Boden Sie in einem einzigen Kaliber

^[1] A pavimento: zone asciutte Floor: dry zones Revêtement de sol : zones sèches Boden: trockenzonen

^[2] A pavimento: zone asciutte e zone umide Floor: dry zones and wet zones Revêtement de sol : zones sèches et zones humides Boden: trockenzonen und feuchtzonen

Caratteristiche tecniche a pagina: Technical features on page: Caractéristiques techniques à la page: Technische Eigenschaften auf Seite: 236

COUNTRY WOOD

Country Ice



Country Bianco



Country Greige



Country Marrone



Country Tortora



Accentuata
Accentuated
Importante
Starke

Vedi pagina: See page: Voir page: Siehe Seite: **237**



COUNTRY WOOD

BATTISCOPA SKIRTING BORD ARRONDI SOCKEL

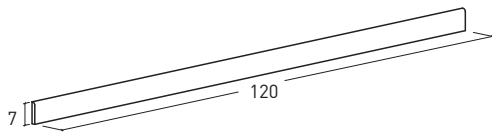

Battiscopa B.C. 9x120

8 pc/box 1,21 kg/pc

COUNTRY WOOD - Naturale



GRADONI E BORDI VASCA SKIMMER STEPS AND SKIMMER POOL BORDERS MARCHES ET TÊTES DE BASSIN SKIMMER STUFEN UND BECKENKÖPFE SKIMMER

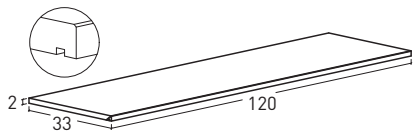

9690

3 pc/box 11 kg/pc

COUNTRY WOOD - Grip

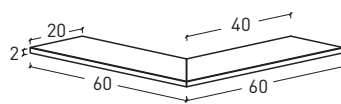

9691

2 pc 45° 2+2 pc/box 5,5 kg/pc

COUNTRY WOOD - Grip

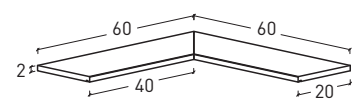

9692

2 pc 45° 2+2 pc/box 5,5 kg/pc

COUNTRY WOOD - Grip

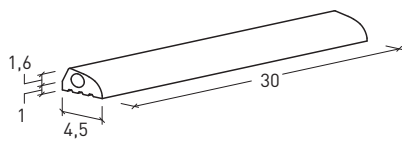

9840

Trim-Box 24 pc/box 0,8 kg/pc

COUNTRY WOOD

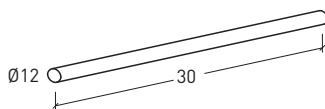

P 214-0296

Polyfill profilo / profile / profil / Profil*

* Vedi pagina: See page: Voir page: Siehe Seite: 42

pezzi speciali / fittings / pièces spéciales / formstücke
sistema a skimmer / skimmer system / systeme skimmers / system skimmer

GRIGLIE IN CERAMICA PERPENDICOLARI PER CANALETTE SPIAGGIA PERPENDICULAR CERAMIC GRATINGS FOR DECK CHANNELS
 GRILLES CÉRAMIQUES PARALLELES POUR CANIVEAU DE PLAGE RECHTWINKLIGE ROSTE AUS KERAMIK FÜR STRANDRINNEN EMPFOHLEN

Vedi pagina: See page: Voir page: Siehe Seite: 216

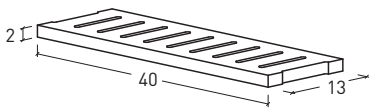

9885 ⁽¹⁾

Padana-Deck 8 pc/box 2,5 kg/pc

COUNTRY WOOD - Grip

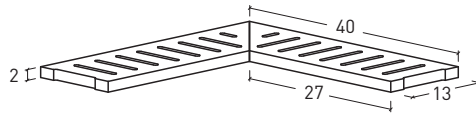

9886 ⁽¹⁾

Padana-Deck 2 pc 45° 4+4 pc/box 2,0 kg/pc

COUNTRY WOOD - Grip



⁽¹⁾ Consigliata solo per piscine private. Consigliata solo per canalette di spiaggia Suggested for private pools only. Recommended for deck channels only.
 Conseillée uniquement pour piscines privées. Conseillée uniquement pour caniveaux de plage Nur für private Schwimmbäder. Nur für Strandrinnen empfohlen

Sistema a Skimmer

SKIMMER SYSTEM
 SYSTEME SKIMMERS
 SYSTEM SKIMMER

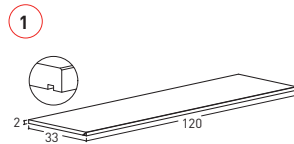
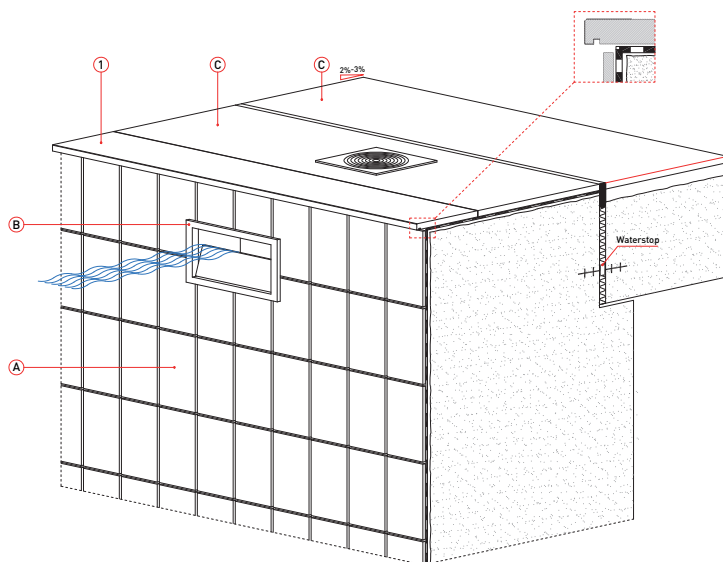

9690

COUNTRY WOOD - Grip



mod. SKCWD 9690

- A LANDSCAPE - Satin_Interno vasca / pool tank / interieur bassin / becken
- B Skimmer
- C COUNTRYWOOD -Grip 20 mm_esterno vasca / pool surround / plage / beckenumgang

Marte

GRANITOGRES

Botticino



Palissandro



Crema Marfil



Bronzetto



Ramora Brown



Emperador

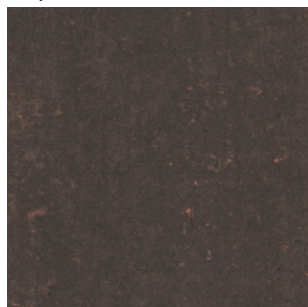

Thassos



Grigio Egeo

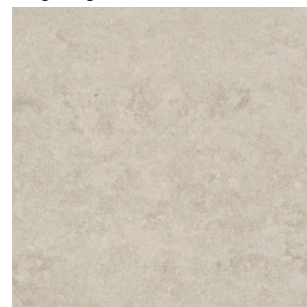

Raggio di Luna



Grigio Marostica



Grigio Magma



Nero Acapulco



Azul Bahia

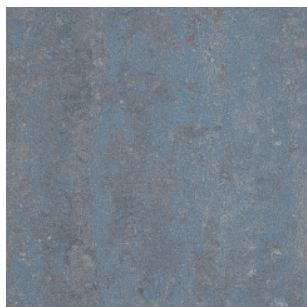

Azul Macauba



Verde Guatemala





Formati Sizes Formats Formate	cm 15x15 5 ⁷ / ₈ "x5 ⁷ / ₈ "	cm 30x30 11 ³ / ₄ "x11 ³ / ₄ "	cm 15x60 5 ⁷ / ₈ "x23 ⁵ / ₈ "	cm 30x60 11 ³ / ₄ "x23 ⁵ / ₈ "	cm 40x40** 15 ³ / ₄ "x15 ³ / ₄ "	cm 60x60 23 ⁵ / ₈ "x23 ⁵ / ₈ "	cm 60x120 23 ⁵ / ₈ "x47 ¹ / ₄ "
Superfici Surfaces Surfaces Oberflächen	●	● ●	●	● ●	●	● ●	●
	mm 9,4	mm 9,4	mm 9,4	mm 9,4	mm 9,4	mm 9,4	mm 9,4

● Naturale ^[1]

DIN 51097 A	XP P 05-010 PN 12	
DIN 51130 R 9	XP P 05-010 PC 6	

● Bocciardata ^[2]

DIN 51097 B	XP P 05-010 PN 18	
DIN 51130 R 11	XP P 05-010 PC 20	

Rettificate in un unico calibro Rectified version in a single caliber Rectifiés en un unique calibre Boden Sie in einem einzigen Kaliber

* Spessore su superficie naturale Thickness on matt surface Epaisseur sur surface mat Stärke der Fliesen mit Matt Oberfläche

** Ad eccezione di: Except for: À l'exception de: Mit Ausnahme von: **Azul Bahia, Azul Macauba, Ramora Brown, Verde Guatemala**

^[1] A pavimento: zone asciutte Floor: dry zones Revêtement de sol : zones sèches Boden: trockenzonen

^[2] A pavimento: zone asciutte e zone umide Floor: dry zones and wet zones Revêtement de sol : zones sèches et zones humides Boden: trockenzonen und feuchtzonen

MARTE

MOSAICI

Mosaico Fresato 3x3

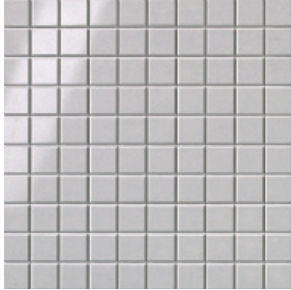

30x30 cm 11^{3/4}"x11^{3/4}"
3x3 cm 1^{1/8}"x1^{1/8}"
1,08 m²/box 21,6 kg/m²

Mosaico Monocolore 3x3*

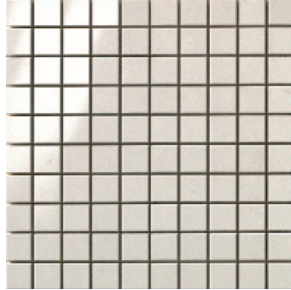

30x30 cm 11^{3/4}"x11^{3/4}"
3x3 cm 1^{1/8}"x1^{1/8}"

su rete on net sur trame auf Netz

6 pc/box 1,5 kg/pc

Mosaico Texture 3x3*

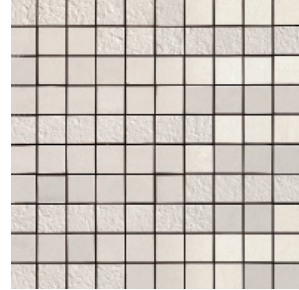

30x30 cm 11^{3/4}"x11^{3/4}"
3x3 cm 1^{1/8}"x1^{1/8}"

su rete on net sur trame auf Netz

6 pc/box 1,5 kg/pc

MARTE - Naturale/Levigata

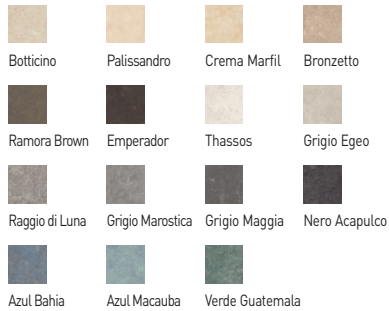

MARTE - Levigata



MARTE - Naturale/Levigata/Bocciardata



* Vedi dettagli a pagina: See details on page: Voir détails à la page: Siehe Details auf Seite: 238



decori e pezzi speciali / decors and fittings / décorations et pièces spéciales / dekore und formstücke

PEZZI SPECIALI PER PISCINE FITTINGS FOR SWIMMING POOLS PIÈCES SPÉCIALES POUR PISCINES FORMSTÜCKE FÜR SCHWIMMBÄDER

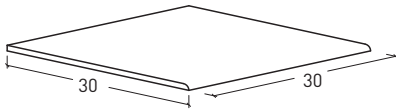

Gradino B.C. 30x30 senza righe

12 pc/box 1,67 kg/pc

MARTE - Bocciardata

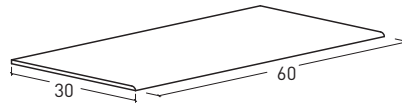
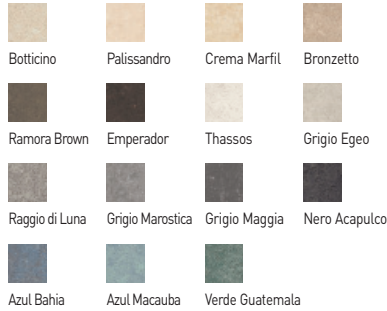

Gradino B.C. 30x60 senza righe

6 pc/box 3,89 kg/pc

MARTE - Bocciardata

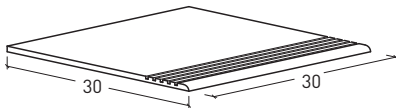
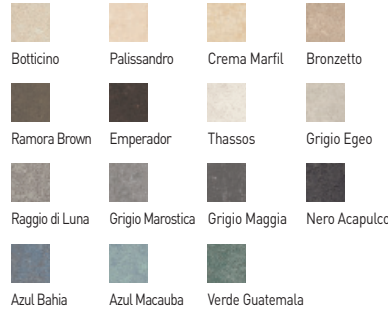

Gradino B.C. 30x30 con righe

12 pc/box 1,67 kg/pc

MARTE - Naturale

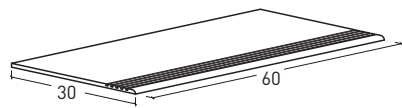

Gradino B.C. 30x60 con righe

6 pc/box 3,89 kg/pc

MARTE - Naturale

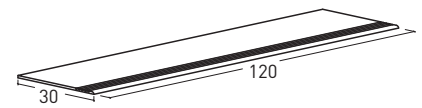

Gradino B.C. 30x120 con righe

3 pc/box 8,28 kg/pc

MARTE - Naturale

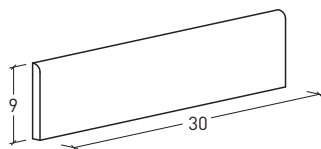

Battiscopa B.C. 9x30

28 pc/box 0,5 kg/pc

MARTE - Naturale

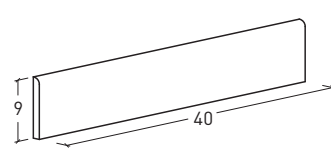

Battiscopa B.C. 9x40

22 pc/box 0,7 kg/pc

MARTE - Naturale

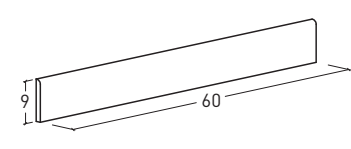
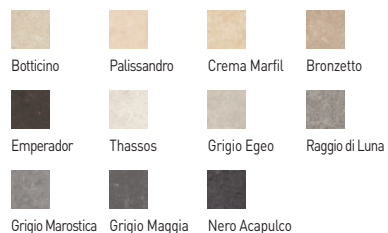

Battiscopa B.C. 9x60

18 pc/box 1,04 kg/pc

MARTE - Naturale

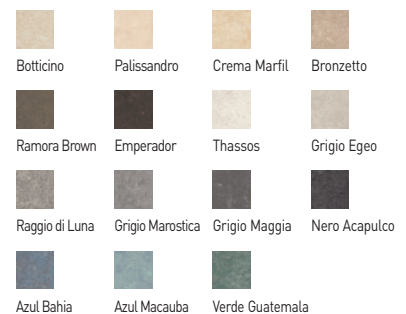

MARTE

PEZZI SPECIALI PER PISCINE FITTINGS FOR SWIMMING POOLS PIÈCES SPÉCIALES POUR PISCINES FORMSTÜCKE FÜR SCHWIMMBÄDER

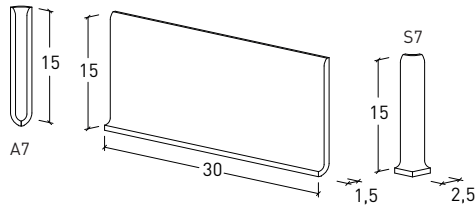

Zoccolo a raccordo B.C. 15x30 + A7 + S7

28 pc/box 0,5 kg/pc

MARTE

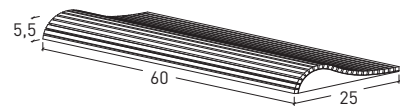
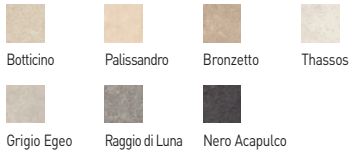

9660 - Pool Wave

1 pc/box 10,0 kg/pc

MARTE - Naturale

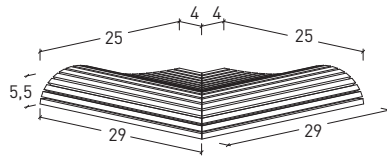

9667 - Pool Wave

2 pc 45° 1+1 pc/box 9,8 kg/pc

MARTE - Naturale

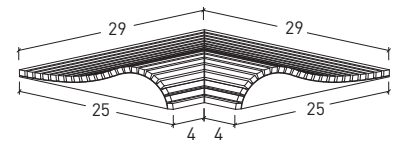

9668 - Pool Wave

2 pc 45° 1+1 pc/box 9,8 kg/pc

MARTE - Naturale

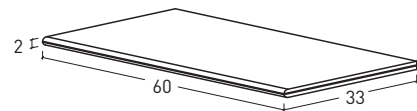

Gradone toro 33x60 senza righe

4 pc/box 9,0 kg/pc

MARTE - Bocciardata

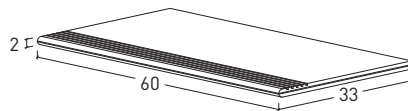

Gradone toro 33x60 con righe

4 pc/box 9,0 kg/pc

MARTE - Naturale

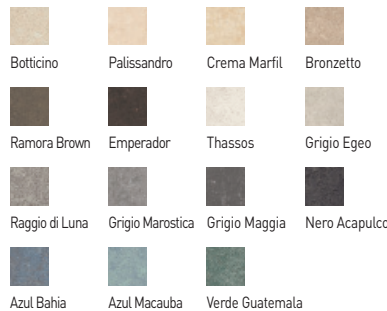

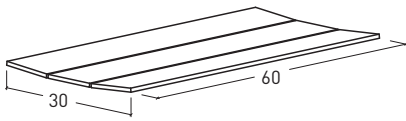

9795*

Padana-Deck 6 pc/box 10,0 kg/pc

MARTE - Naturale

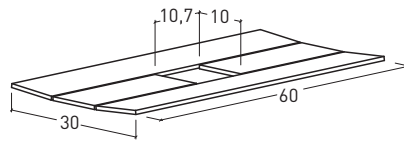

9796*

Padana-Deck 6 pc/box 9,8 kg/pc

MARTE - Naturale

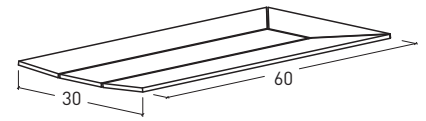

9797*

Padana-Deck 6 pc/box 9,8 kg/pc

MARTE - Naturale



Vedi pagina: See page: Voir page: Siehe Seite: **213**

* Fornito assemblato su rete, da posizionarsi/inclinarsi in opera. Assemblaggio ad inclinazione flessibile fino a max 10%
 Supplied on mesh to be positioned/adapted on site. Assembly with flexible slope up to max 10%
 Fourni assemblé sur grille, à positionner/incliner sur chantier. Assemblage flexible avec pentes jusqu'à 10%
 Wird auf Netz montiert geliefert, auf der Baustelle zu positionieren neigen. Flexibel Montage mit Neigungen bis max 10%



Pietre di Sardegna

PIETRE NATIVE

Porto Rotondo



Porto Cervo



Stintino



Cala Luna



Punta Molara



Caprera









Tavolara









Accentuata
Accentuated
Importante
Starke

Vedi pagina: See page: Voir page: Siehe Seite: 237

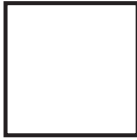





					
Formati Sizes Formats Formate	cm 30x30 11 ³ / ₄ "x11 ³ / ₄ "	cm 15x60 5 ⁷ / ₈ "x23 ⁵ / ₈ "	cm 30x60 11 ³ / ₄ "x23 ⁵ / ₈ "	cm 60x60 23 ⁵ / ₈ "x23 ⁵ / ₈ "	cm 60x60 23 ⁵ / ₈ "x23 ⁵ / ₈ "
Tavolara	●	●	●	● ●	●
Caprera	●	●	●	● ●	●
Punta Molara	●	●	●	● ●	●
Porto Rotondo	●	●	●	● ●	●
Cala Luna	●	●	●	● ●	●
Stintino	●	●	●	● ●	●
Porto Cervo	●	●	●	● ●	●
	mm 9	mm 9	mm 10 mm 9	mm 10	mm 20

					
Formati Sizes Formats Formate	cm 45x90 17 ³ / ₄ "x35 ³ / ₈ "	cm 90x90 35 ³ / ₈ "x35 ³ / ₈ "	cm 90x90 35 ³ / ₈ "x35 ³ / ₈ "	cm 60x120 23 ⁵ / ₈ "x47 ¹ / ₄ "	cm 60x120 23 ⁵ / ₈ "x47 ¹ / ₄ "
Tavolara	●	●	●	●	●
Caprera	●	●	●	●	●
Punta Molara	●	●	●	●	●
Porto Rotondo	●	●	●	●	●
Cala Luna	●	●	●	●	●
Stintino	●	●	●	●	●
Porto Cervo	●	●	●	●	●
	mm 10	mm 10	mm 20	mm 10	mm 20

● Naturale ⁽¹⁾

● Grip ⁽²⁾

DIN 51097 A	XP P 05-010 PN 12	
DIN 51130 R 10	XP P 05-010 PC 10	

DIN 51097 B	XP P 05-010 PN 18	
DIN 51130 R 11	XP P 05-010 PC 20	

Rettificata in un unico calibro Rectified version in a single caliber Rectifiés en un unique calibre Boden Sie in einem einzigen Kaliber

⁽¹⁾ A pavimento: zone asciutte Floor: dry zones Revêtement de sol : zones sèches Boden: trockenzonen

⁽²⁾ A pavimento: zone asciutte e zone umide Floor: dry zones and wet zones Revêtement de sol : zones sèches et zones humides Boden: trockenzonen und feuchtzonen

PIETRE DI SARDEGNA

MOSAICI*

Mosaico 3x3

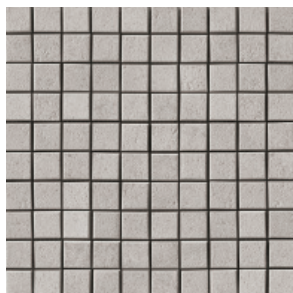

30x30 cm 11^{3/4}"x11^{3/4}"
3x3 cm 1^{1/8}"x1^{1/8}"

su rete on net sur trame auf Netz

1,08 m²/box 21,6 kg/m²

PIETRE DI SARDEGNA - Naturale



Mosaico 6x6



30x30 cm 11^{3/4}"x11^{3/4}"
6x6 cm 2^{3/8}"x2^{3/8}"

su rete on net sur trame auf Netz

6 pc/box 1,53 kg/pc

PIETRE DI SARDEGNA - Naturale



Composizione A



30x60 cm 11^{3/4}"x23^{5/8}"

6 pc/box 3,88 kg/pc

PIETRE DI SARDEGNA - Naturale



* Vedi dettagli a pagina: See details on page: Voir détails à la page: Siehe Details auf Seite: 238

decori e pezzi speciali / decors and fittings / décorations et pièces spéciales / dekore und formstücke

PEZZI SPECIALI PER PISCINE FITTINGS FOR SWIMMING POOLS PIÈCES SPÉCIALES POUR PISCINES FORMSTÜCKE FÜR SCHWIMMBÄDER

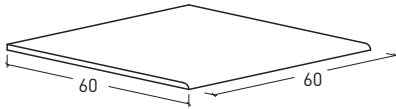

Gradino B.C. 60x60 senza righe

4 pc/box 7,75 kg/pc

PIETRE DI SARDEGNA - Naturale / Grip

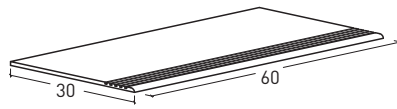

Gradino B.C. 30x60 con righe

6 pc/box 3,89 kg/pc

PIETRE DI SARDEGNA - Naturale

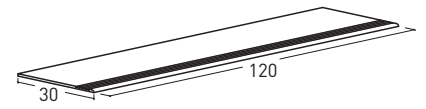

Gradino B.C. 30x120 con righe

3 pc/box 8,28 kg/pc

PIETRE DI SARDEGNA - Naturale

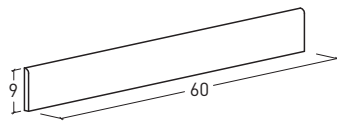

Battiscopa B.C. 9x60

18 pc/box 1,04 kg/pc

PIETRE DI SARDEGNA - Naturale

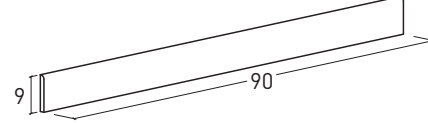

Battiscopa B.C. 9x90

9 pc/box 1,89 kg/pc

PIETRE DI SARDEGNA - Naturale

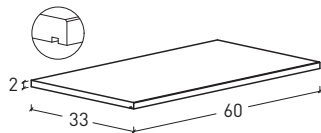

9550

3 pc/box 9,1 kg/pc

PIETRE DI SARDEGNA - Grip

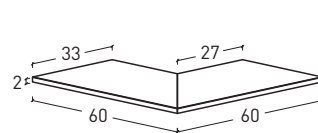

9557

2 pc 45° 1+1 pc/box 9,2 kg/pc

PIETRE DI SARDEGNA - Grip

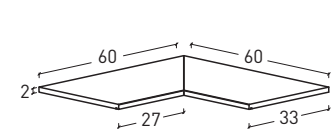

9558

2 pc 45° 1+1 pc/box 9,2 kg/pc

PIETRE DI SARDEGNA - Grip

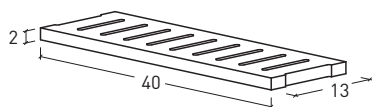

9885 (1)*

Padana-Deck 8 pc/box 2,0 kg/pc

PIETRE DI SARDEGNA - Grip

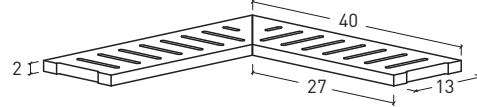
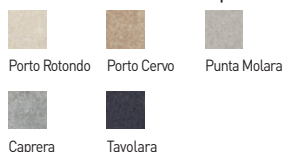

9886 (1)*

Padana-Deck 2 pc 45° 4+4 pc/box 3,5 kg/pc

PIETRE DI SARDEGNA - Grip



* Vedi pagina: See page: Voir page: Siehe Seite: 216

(1) Consigliata solo per piscine private. Consigliata solo per canalette di spiaggia Suggested for private pools only. Recommended for deck channels only. Conseillée uniquement pour piscines privées. Conseillée uniquement pour caniveaux de plage Nur für private Schwimmbäder. Nur für Strandrinnen empfohlen

Pietra Baugé

PIETRE NATIVE

Bianca



Beige



Grigia









Antracite





Accentuata
Accentuated
Importante
Starke



Vedi pagina: See page: Voir page: Siehe Seite: **237**

Formati Sizes Formats Formate					
	cm 30x60 11 ³ / ₄ "x23 ⁵ / ₈ "	cm 60x60 23 ⁵ / ₈ "x23 ⁵ / ₈ "	cm 60x60 23 ⁵ / ₈ "x23 ⁵ / ₈ "	cm 90x90 35 ³ / ₈ "x35 ³ / ₈ "	cm 90x90 35 ³ / ₈ "x35 ³ / ₈ "
Superfici Surfaces Surfaces Oberflächen	●	●	●	●	●
	mm 10 mm 9 mm 9*	mm 10	mm 20	mm 10	mm 20

● Naturale ^[1]

DIN 51097 B	XP P 05-010 PN 18	
DIN 51130 R 10	XP P 05-010 PC 10	

● Grip ^[2]

DIN 51097 C	XP P 05-010 PN 24	
DIN 51130 R 11	XP P 05-010 PC 20	

Rettificata in un unico calibro Rectified version in a single caliber Rectifiés en un unique calibre Boden Sie in einem einzigen Kaliber

* Non rettificato Unrectified Non rectifié Nicht kalibriert

^[1] A pavimento: zone asciutte Floor: dry zones Revêtement de sol : zones sèches Boden: trokenzonen

^[2] A pavimento: zone asciutte e zone umide Floor: dry zones and wet zones Revêtement de sol : zones sèches et zones humides Boden: trokenzonen und feuchtzonen

Caratteristiche tecniche a pagina: Technical features on page: Caractéristiques techniques à la page: Technische Eigenschaften auf Seite: **235**

MOSAICI*

Mosaico 6x6



30x30 cm 11^{3/4}"x11^{3/4}"
6x6 cm 2^{3/8}"x2^{3/8}"

su rete on net sur trame auf Netz

6 pc/box 1,53 kg/pc

PIETRA BAUGÉ - Naturale



Mosaico 10x10



30x30 cm 11^{3/4}"x11^{3/4}"
10x10 cm 4"x4"

su rete on net sur trame auf Netz

6 pc/box 1,53 kg/pc

PIETRA BAUGÉ - Naturale



* Vedi dettagli a pagina: See details on page: Voir détails à la page: Siehe Details auf Seite: 238

PEZZI SPECIALI PER PISCINE FITTINGS FOR SWIMMING POOLS PIÈCES SPÉCIALES POUR PISCINES FORMSTÜCKE FÜR SCHWIMMBÄDER

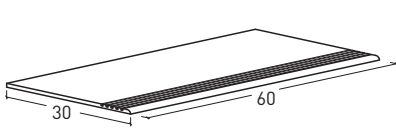

Gradino B.C. 30x60 con righe

6 pc/box 3,89 kg/pc

PIETRA BAUGÉ - Naturale

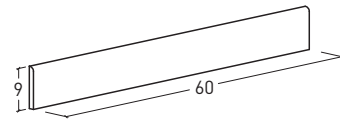

Battiscopa B.C. 9x60

18 pc/box 1,04 kg/pc

PIETRA BAUGÉ - Naturale

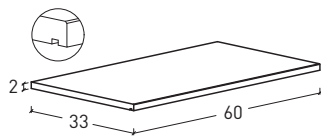

9550

3 pc/box 9,1 kg/pc

PIETRA BAUGÉ - Grip

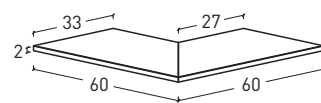

9557

2 pc 45° 1+1 pc/box 9,2 kg/pc

PIETRA BAUGÉ - Grip

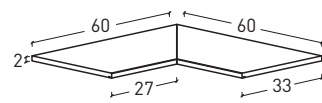

9558

2 pc 45° 1+1 pc/box 9,2 kg/pc

PIETRA BAUGÉ - Grip

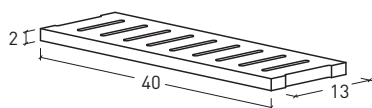

9885 ^{(1)*}

Padana-Deck 8 pc/box 2,0 kg/pc

PIETRA BAUGÉ - Grip

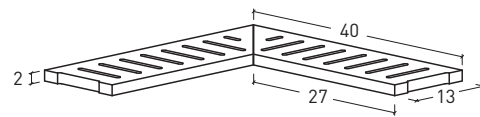

9886 ^{(1)*}

Padana-Deck 2 pc 45° 4+4 pc/box 3,5 kg/pc

PIETRA BAUGÉ - Grip



* Vedi pagina: See page: Voir page: Siehe Seite: 216

⁽¹⁾ Consigliata solo per piscine private. Consigliata solo per canalette di spiaggia Suggested for private pools only. Recommended for deck channels only.
Conseillée uniquement pour piscines privées. Conseillée uniquement pour caniveaux de plage Nur für private Schwimmbäder. Nur für Strandrinnen empfohlen

Chalon

PIETRE NATIVE

Cream



Beige



Kaki



Grey



Accentuata
Accentuated
Importante
Starke

Vedi pagina: See page: Voir page: Siehe Seite: **237**

Formati Sizes Formats Formate	cm 45x45 17 ³ / ₄ "x17 ³ / ₄ "	cm 30x60 11 ³ / ₄ "x23 ⁵ / ₈ "	cm 60x60 23 ⁵ / ₈ "x23 ⁵ / ₈ "	cm 60x120 23 ⁵ / ₈ "x47 ¹ / ₄ "	cm 60x120* 23 ⁵ / ₈ "x47 ¹ / ₄ "
Superfici Surfaces Surfaces Oberflächen	●	● ● ● ●**	● ●	● ●	●
	mm 10	mm 10 mm 9	mm 10	mm 10	mm 20

● Naturale ⁽¹⁾



● Grip ⁽¹⁾



● Grip A+B ^{(2)**}



Rettificate in un unico calibro Rectified version in a single caliber Rectifiés en un unique calibre Boden Sie in einem einzigen Kaliber

* Disponibile nei colori: Available in the colours: Disponible dans les couleurs: Verfügbar in den folgenden Farben: **Beige, Cream, Grey**

** Superficie Grip A+B solo su richiesta, spessore 9 mm Surface Grip A+B on request only, thickness 9 mm Surface Grip A+B uniquement sur demande, épaisseur 9 mm Oberfläche Grip A+B nur auf Anfrage, Stärke 9 mm

⁽¹⁾ A pavimento: zone asciutte Floor: dry zones Revêtement de sol : zones sèches Boden: trockenzonen

⁽²⁾ A pavimento: zone asciutte e zone umide Floor: dry zones and wet zones Revêtement de sol : zones sèches et zones humides Boden: trockenzonen und feuchtzonen

Caratteristiche tecniche a pagina: Technical features on page: Caractéristiques techniques à la page: Technische Eigenschaften auf Seite: **235**

MOSAICI*

Mosaico 6x6



30x30 cm 11³/₄"x11³/₄"
6x6 cm 2³/₈"x2³/₈"

su rete on net sur trame auf Netz

6 pc/box 1,53 kg/pc

CHALON - Naturale



Mosaico 10x10



30x30 cm 11³/₄"x11³/₄"
10x10 cm 4"x4"

su rete on net sur trame auf Netz

6 pc/box 1,53 kg/pc

CHALON - Naturale



* Vedi dettagli a pagina:
See details on page:
Voir détails à la page:
Siehe Details auf Seite: **238**

PEZZI SPECIALI PER PISCINE FITTINGS FOR SWIMMING POOLS PIÈCES SPÉCIALES POUR PISCINES FORMSTÜCKE FÜR SCHWIMMBÄDER

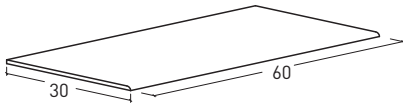

Gradino B.C 30x60 senza righe

6 pc/box 3,89 kg/pc

CHALON - Naturale/Grip

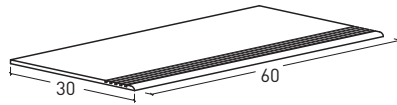

Gradino B.C 30x60 con righe

6 pc/box 3,89 kg/pc

CHALON - Naturale

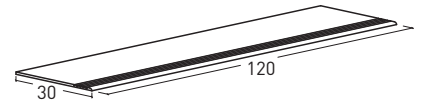

Gradino B.C 30x120 con righe

6 pc/box 8,28 kg/pc

CHALON - Naturale

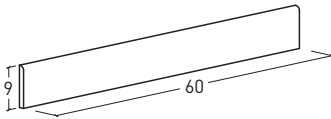

Battiscopa B.C. 9x60

18 pc/box 1,04 kg/pc

CHALON - Naturale

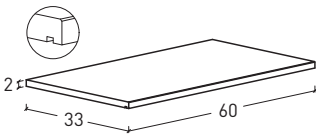

9550

3 pc/box 9,1 kg/pc

CHALON - Grip

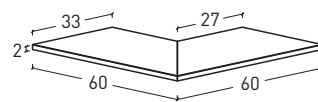

9557

2 pc 45° 1+1 pc/box 9,2 kg/pc

CHALON - Grip

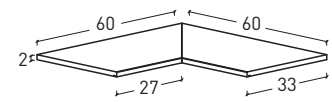

9558

2 pc 45° 1+1 pc/box 9,2 kg/pc

CHALON - Grip

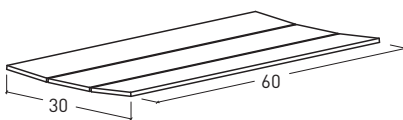

9795* (1)

Padana-Deck 6 pc/box 10,0 kg/pc

CHALON -Grip A+B

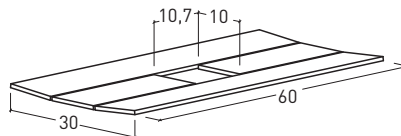

9796* (1)

Padana-Deck 6 pc/box 9,8 kg/pc

CHALON -Grip A+B

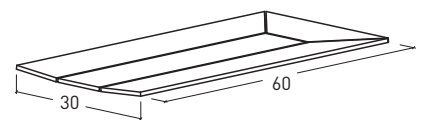

9797* (1)

Padana-Deck 6 pc/box 9,8 kg/pc

CHALON -Grip A+B



* Vedi pagina: See page: Voir page: Siehe Seite: 213

(1) Fornito assemblato su rete, da posizionarsi/inclinarsi in opera. Assemblaggio ad inclinazione flessibile fino a max 10%. Ordinabile soltanto su richiesta e simultaneamente alle corrispondenti piastrelle nella stessa superficie
 Supplied on mesh to be positioned/adapted on site. Assembly with flexible slope up to max 10%. Purchasing on request only and simultaneously with the corresponding tiles in the same surface
 Fourni assemblé sur grille, à positionner/incliner sur chantier. Assemblage flexible avec pentes jusqu'à 10%. À commander uniquement sur demande et simultanément aux carreaux dans la même surface
 Wird auf Netz montiert geliefert, auf der Baustelle zu positionieren neigen. Flexibel Montage mit Neigungen bis max 10%. Kann gleichzeitig nur auf Antrag und mit dem entsprechenden fliesen mit derselben Oberfläche

Boulder

PIETRE NATIVE

Cloud

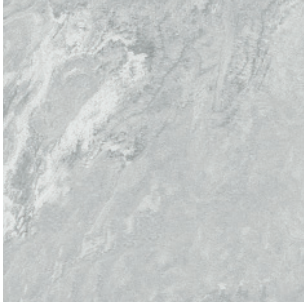

Fossil



Ink



Rust

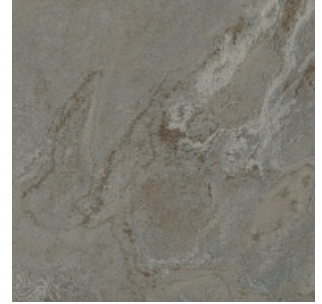

Accentuata
Accentuated
Importante
Starke

Vedi pagina: See page: Voir page: Siehe Seite: **237**

Formati Sizes
Formats Formate



cm 30x60
11³/₄" x 23⁵/₈"



cm 45x90
17³/₄" x 35³/₈"

Superfici Surfaces
Surfaces Oberflächen



mm 9
mm 9*

mm 10



● Naturale ⁽¹⁾

DIN 51097 B	XP P 05-010 PN 18	
DIN 51130 R 10	XP P 05-010 PC 10	

● Grip ⁽¹⁾

DIN 51130 R 11	XP P 05-010 PC 20	
-------------------	----------------------	--

● Grip A+B ^{(2)**}

DIN 51097 B	XP P 05-010 PN 18	
DIN 51130 R 11	XP P 05-010 PC 20	

Rettificate in un unico calibro Rectified version in a single caliber Rectifiés en un unique calibre Boden Sie in einem einzigen Kaliber

* Non rettificato Unrectified Non rectifié Nicht kalibriert

** Superficie Grip A+B solo su richiesta e solo rettificato Surface Grip A+B on request only and rectified only Surface Grip A+B uniquement sur demande en version rectifiée
Oberfläche Grip A+B nur auf Anfrage und nur kalibriert

⁽¹⁾ A pavimento: zone asciutte Floor: dry zones Revêtement de sol : zones sèches Boden: trockenzone

⁽²⁾ A pavimento: zone asciutte e zone umide Floor: dry zones and wet zones Revêtement de sol : zones sèches et zones humides Boden: trockenzone und feuchtenzone

Caratteristiche tecniche a pagina: Technical features on page: Caractéristiques techniques à la page: Technische Eigenschaften auf Seite: **235**

MOSAICI*

Mosaico 6x6



30x30 cm 11^{3/4}"x11^{3/4}"
6x6 cm 2^{3/8}"x2^{3/8}"

su rete on net sur trame auf Netz

6 pc/box 1,53 kg/pc

BOULDER - Naturale



Cloud Fossil Ink Rust

Composizione A

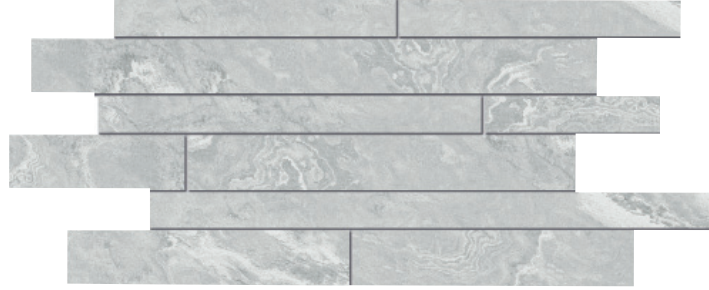

30x60 cm 11^{3/4}"x23^{5/8}"

su rete on net sur trame auf Netz

6 pc/box 3,88 kg/pc

BOULDER - Naturale



Cloud Fossil Ink Rust

* Vedi dettagli a pagina: See details on page: Voir détails à la page: Siehe Details auf Seite: 238

PEZZI SPECIALI PER PISCINE FITTINGS FOR SWIMMING POOLS PIÈCES SPÉCIALES POUR PISCINES FORMSTÜCKE FÜR SCHWIMMBÄDER

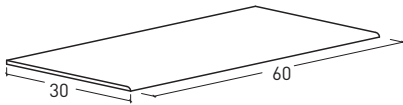

Gradino B.C. 30x60 senza righe

6 pc/box 3,89 kg/pc

BOULDER - Grip



Cloud Fossil Ink Rust

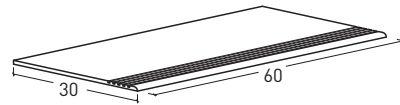

Gradino B.C. 30x60 con righe

6 pc/box 3,89 kg/pc

BOULDER - Naturale



Cloud Fossil Ink Rust

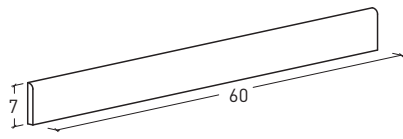

Battiscopa B.C. 7x60

18 pc/box 0,73 kg/pc

BOULDER - Naturale



Cloud Fossil Ink Rust

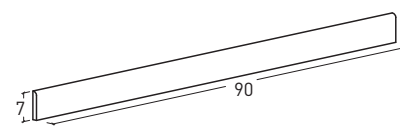

Battiscopa B.C. 7x90

9 pc/box 1,76 kg/pc

BOULDER - Naturale



Cloud Fossil Ink Rust

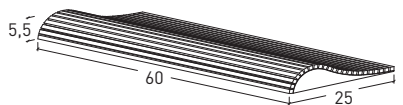

9660 - Pool Wave

1 pc/box 10,0 kg/pc

BOULDER - Grip



Cloud Fossil Ink Rust

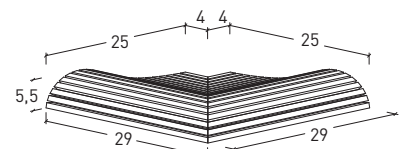

9667 - Pool Wave

2 pc 45° 1+1 pc/box 9,8 kg/pc

BOULDER - Grip



Cloud Fossil Ink Rust

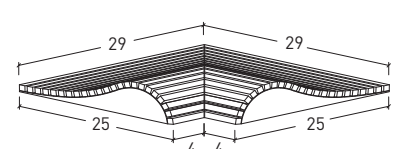

9668 - Pool Wave

2 pc 45° 1+1 pc/box 9,8 kg/pc

BOULDER - Grip



Cloud Fossil Ink Rust

Petra

PIETRE NATIVE

Petra Oro



Petra Grigia

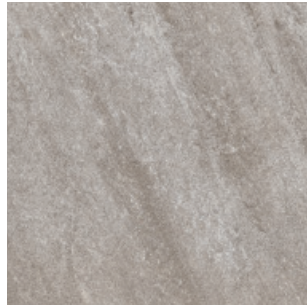

Petra Antracite

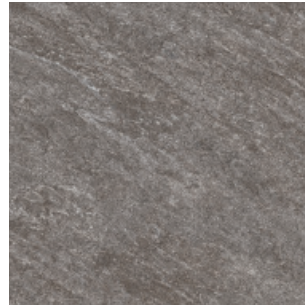

Petra Perla



Petra Bianca



Petra Sabbia



Accentuata
Accentuated
Importante
Starke

Vedi pagina: See page: Voir page: Siehe Seite: **237**

Formati Sizes Formats Formate	cm 8,2x25 3 ¹ / ₄ "x9 ⁷ / ₈ "	cm 20x20 7 ⁷ / ₈ "x7 ⁷ / ₈ "	cm 20x40 7 ⁷ / ₈ "x15 ³ / ₄ "	cm 30x60 11 ³ / ₄ "x23 ⁵ / ₈ "
Superfici Surfaces Surfaces Oberflächen	●	●	●	● ●
	mm 9	mm 8	mm 8	mm 9
Formati Sizes Formats Formate	cm 60x60 23 ⁵ / ₈ "x23 ⁵ / ₈ "	cm 60x60 23 ⁵ / ₈ "x23 ⁵ / ₈ "	cm 60x120 23 ⁵ / ₈ "x47 ¹ / ₄ "	cm 60x120 23 ⁵ / ₈ "x47 ¹ / ₄ "
Superfici Surfaces Surfaces Oberflächen	● ●	●	● ●	●
	mm 9	mm 20*	mm 9	mm 20*

● Naturale ^[1]

DIN 51097 B	XP P 05-010 PN 18	
DIN 51130 R 10	XP P 05-010 PC 10	

● Grip ^[2]

DIN 51097 B	XP P 05-010 PN 18	
DIN 51130 R 11	XP P 05-010 PC 20	

* Solo nei colori: Only in the colours: Seulement dans les couleurs: Nur in die Farben: **Grigia - Perla - Sabbia**

^[1] A pavimento: zone asciutte Floor: dry zones Revêtement de sol : zones sèches Boden: trokenzonen

^[2] A pavimento: zone asciutte e zone umide Floor: dry zones and wet zones Revêtement de sol : zones sèches et zones humides Boden: trokenzonen und feuchtzonen

Caratteristiche tecniche a pagina: Technical features on page: Caractéristiques techniques à la page: Technische Eigenschaften auf Seite: **235**

colori / colours / couleurs / farben
 decori / decors / décorations / dekore

MOSAICI*

Mosaico 5x5



30x30 cm 11^{3/4}"x11^{3/4}"
 5x5 cm 2"x2"

su rete on net sur trame auf Netz

6 pc/box 1,53 kg/pc

PETRA



Petra Oro



Petra Grigia



Petra Antracite



Petra Perla



Petra Bianca



Petra Sabbia

Mosaico 5x15



30x30 cm 11^{3/4}"x11^{3/4}"
 5x15 cm 2"x5^{7/8}"

su rete on net sur trame auf Netz

6 pc/box 1,53 kg/pc

PETRA



Petra Oro



Petra Grigia



Petra Antracite



Petra Perla



Petra Bianca



Petra Sabbia

Composizione A



30x60 cm 11^{3/4}"x23^{5/8}"

su rete on net sur trame auf Netz

6 pc/box 3,88 kg/pc

PETRA



Petra Oro



Petra Grigia



Petra Antracite



Petra Perla



Petra Bianca



Petra Sabbia

* Vedi dettagli a pagina: See details on page: Voir détails à la page: Siehe Details auf Seite: 238

PETRA

PEZZI SPECIALI PER PISCINE FITTINGS FOR SWIMMING POOLS PIÈCES SPÉCIALES POUR PISCINES FORMSTÜCKE FÜR SCHWIMMBÄDER

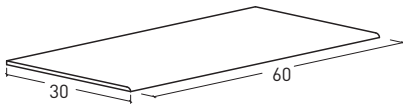

Gradino B.C 30x60 senza righe

6 pc/box 3,89 kg/pc

PETRA - Naturale / Grip



Petra Oro



Petra Grigia



Petra Antracite



Petra Perla



Petra Bianca



Petra Sabbia

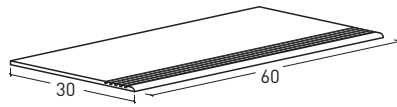

Gradino B.C 30x60 con righe

6 pc/box 3,89 kg/pc

PETRA - Naturale



Petra Oro



Petra Grigia



Petra Antracite



Petra Perla



Petra Bianca



Petra Sabbia

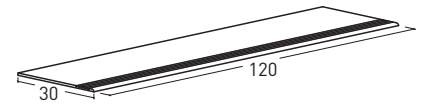

Gradino B.C 30x120 con righe

3 pc/box 8,28 kg/pc

PETRA - Naturale



Petra Oro



Petra Grigia



Petra Antracite



Petra Perla



Petra Bianca



Petra Sabbia

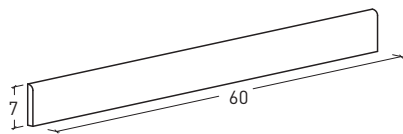

Battiscopa B.C. 7x60

18 pc/box 1,04 kg/pc

PETRA - Naturale



Petra Oro



Petra Grigia



Petra Antracite



Petra Perla



Petra Bianca



Petra Sabbia

Formato 8,2x25

Petra Perla



cm 8,2x25 - 3¹/₄" x 9⁷/₈"

Petra Bianca



cm 8,2x25 - 3¹/₄" x 9⁷/₈"

Petra Grigia

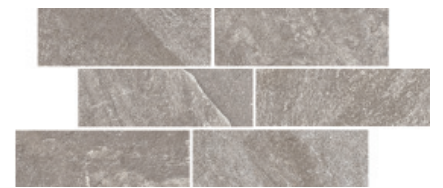

cm 8,2x25 - 3¹/₄" x 9⁷/₈"

Petra Sabbia



cm 8,2x25 - 3¹/₄" x 9⁷/₈"

Petra Oro



cm 8,2x25 - 3¹/₄" x 9⁷/₈"

Petra Antracite



cm 8,2x25 - 3¹/₄" x 9⁷/₈"



Eco Concrete

GRESPLUS

Eco Bianco



Eco Beige



Eco Cenere



Eco Grigio



Eco Antracite



Media
Medium
Modérée
Mittlere

Vedi pagina: See page: Voir page: Siehe Seite: **237**

Formati Sizes
Formats Formate



cm 30x60
11³/₄" x 23⁵/₈"



cm 60x60
23⁵/₈" x 23⁵/₈"



cm 60x120
23⁵/₈" x 47¹/₄"

Superfici Surfaces
Surfaces Oberflächen



mm 8



mm 9



mm 9

● Naturale ^[1]

DIN 51097 B	XP P 05-010 PN 18	
DIN 51130 R 10	XP P 05-010 PC 10	

● Grip ^[2]

DIN 51097 B	XP P 05-010 PN 18	
DIN 51130 R 11	XP P 05-010 PC 20	

Rettificata in un unico calibro Rectified version in a single caliber Rectifiés en un unique calibre Boden Sie in einem einzigen Kaliber

^[1] A pavimento: zone asciutte Floor: dry zones Revêtement de sol : zones sèches Boden: trokenzonen

^[2] A pavimento: zone asciutte e zone umide Floor: dry zones and wet zones Revêtement de sol : zones sèches et zones humides Boden: trokenzonen und feuchtzonen

Caratteristiche tecniche a pagina: Technical features on page: Caractéristiques techniques à la page: Technische Eigenschaften auf Seite: **234**

MOSAICI*

Mosaico 6x6

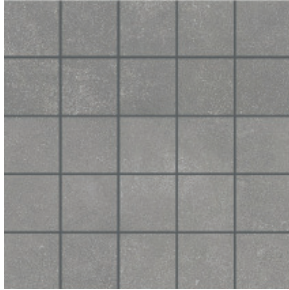

30x30 cm 11^{3/4}"x11^{3/4}"
6x6 cm 2^{3/8}"x2^{3/8}"

su rete on net sur trame auf Netz

6 pc/box 1,53 kg/pc

ECO CONCRETE



Eco Bianco Eco Beige Eco Cenere Eco Grigio Eco Antracite

PEZZI SPECIALI PER PISCINE FITTINGS FOR SWIMMING POOLS PIÈCES SPÉCIALES POUR PISCINES FORMSTÜCKE FÜR SCHWIMMBÄDER

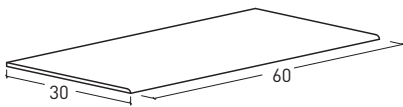

Gradino B.C. 30x60 senza righe

6 pc/box 3,89 kg/pc

ECO CONCRETE - Naturale



Eco Bianco Eco Beige Eco Cenere Eco Grigio Eco Antracite

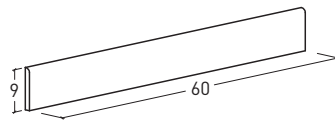

Battiscopa B.C. 9x60

18 pc/box 1,04 kg/pc

ECO CONCRETE - Naturale



Eco Bianco Eco Beige Eco Cenere Eco Grigio Eco Antracite

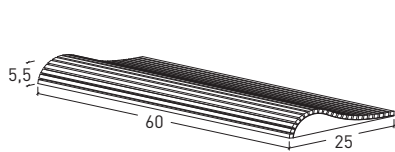

9660 - Pool Wave

1 pc/box 10,0 kg/pc

ECO CONCRETE - Grip



Eco Bianco Eco Beige Eco Cenere Eco Grigio Eco Antracite

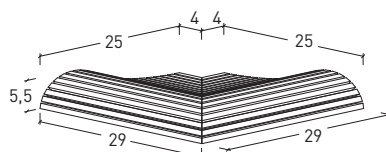

9667 - Pool Wave

2 pc 45° 1+1 pc/box 9,8 kg/pc

ECO CONCRETE - Grip



Eco Bianco Eco Beige Eco Cenere Eco Grigio Eco Antracite

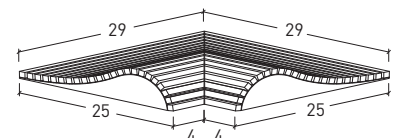

9668 - Pool Wave

2 pc 45° 1+1 pc/box 9,8 kg/pc

ECO CONCRETE - Grip



Eco Bianco Eco Beige Eco Cenere Eco Grigio Eco Antracite

Padana Deck_Wellness&Spa canalette per esterni vasca

CHANNELS FOR POOL DECKS
CANIVEAUX DE PLAGE
BECKENUMGANGSRINNEN

Anche nel caso delle collezioni Casalgrande Padana sono disponibili un insieme di pezzi speciali e sistemi dedicati al recupero dell'acqua, sia con sistemi puntuali, sia creando canalizzazioni complete con e senza griglie di copertura.

Even for the collections Casalgrande Padana, a line of fittings and systems designed specifically to collect water on pool deck can be used to recover water through a system of channels with or without covering grating.

Même pour les collections Casalgrande Padana, une ligne de pièces spéciales et systèmes spécifiques permet de récupérer l'eau moyennant un système de caniveaux sans ou avec grille de recouvrement.

Auch im Fall der Casalgrande Padana Kollektionen gibt es eine Reihe von speziellen Stücken und Systemen für die Wasserrückgewinnung, sowohl mittels punktueller Systemen als auch anhand der Verlegung kompletter Kanalisierungen mit und ohne Abdeckroste.



Mod.CP 007

CANALETTA PIANA E SCARICO A QUATTRO PENDENZE ANTISCIVOLO NON-SLIP FLAT CHANNEL AND INDEPENDENT WATER OUTLET
CANIVEAU PLAT ET CUNETTE DE'ECOLEMENT ANTIDERAPANTS NON-SLIP FLACHRINNE UND FREIES WASSERABLAUF

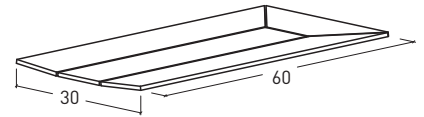
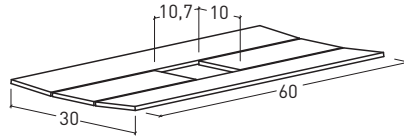
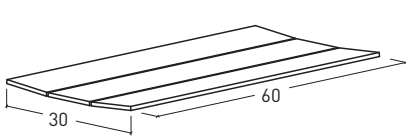

9795*

Padana-Deck 6 pc/box 10,0 kg/pc

MINERAL CHROM - Naturale



AMAZZONIA - Grip



MARTE - Bocciardata



CHALON -Grip A+B**



9796*

Padana-Deck 6 pc/box 9,8 kg/pc

MINERAL CHROM - Naturale



AMAZZONIA - Grip



MARTE - Bocciardata



CHALON -Grip A+B**



9797*

Padana-Deck 6 pc/box 9,8 kg/pc

MINERAL CHROM - Naturale



AMAZZONIA - Grip



MARTE - Bocciardata



CHALON -Grip A+B**



* Fornito assemblato su rete, da posizionarsi/inclinarsi in opera. Assemblaggio ad inclinazione flessibile fino a max 10% Supplied on mesh to be positioned/adapted on site. Assembly with flexible slope up to max 10%
Fourni assemblé sur grille, à positionner/incliner sur chantier. Assemblage flexible avec pentes jusqu'à 10% Wird auf Netz montiert geliefert, auf der Baustelle zu positionieren neigen. Flexibel Montage mit Neigungen bis max 10%

** Ordinabile soltanto su richiesta e simultaneamente alle corrispondenti piastrelle nella stessa superficie. Purchasing on request only and simultaneously with the corresponding tiles in the same surface
À commander uniquement sur demande et simultanément aux carreaux dans la même surface Kann gleichzeitig nur auf Antrag und mit dem entsprechenden Fliesen mit derselben Oberfläche

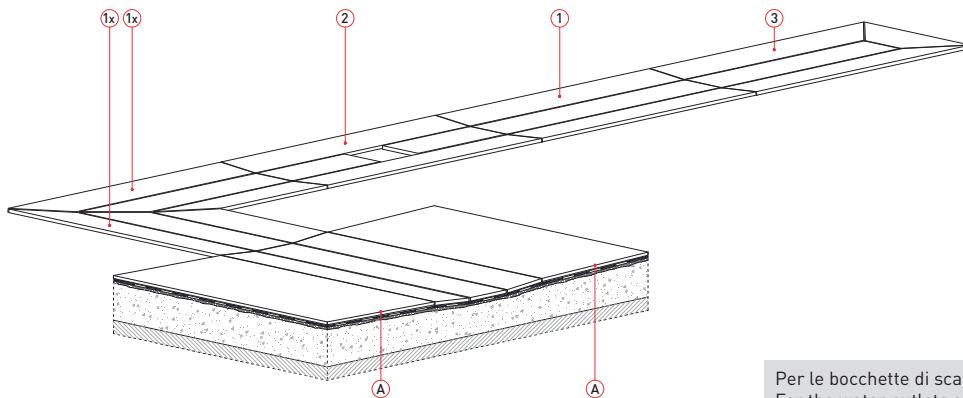

A piastrella spiaggia pool deck tile carreau de plage beckenumfang-fliese

x= Tagliato in cantiere To be cut on the job site À couper en chantier Auf der baustelle geschnitten

Per le bocchette di scarico da applicare a questo sistema vedi pag. 219
For the water outlets suitable to this system see pages 219
Pour les siphons de ce système voir pages 219
Für die Wasserabläufe dieses Systems siehe Seiten 219

Mod.CP 003

CANALETTE CON GRIGLIE DI COPERTURA CHANNELS WITH GRATINGS CANIVEAUX AVEC GRILLES RINNEN MIT ABDECKROSTE

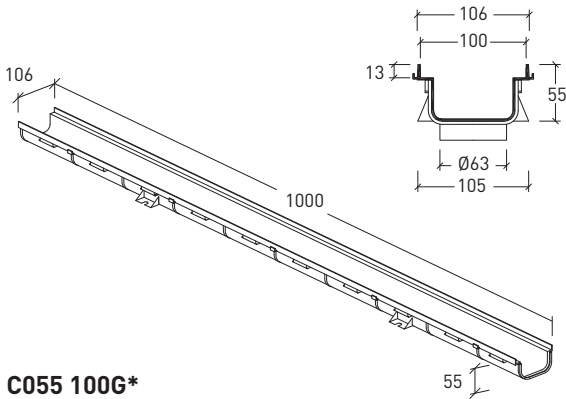

C055 100G*

Padana-Grid 12 pc/box 0,9 kg/pc

Canaletta in PVC con scarico verticale Ø 40 mm o Ø 63 mm **
 PVC channel with vertical outlet Ø 40 mm or Ø 63 mm
 Caniveau en PVC avec évacuation verticale Ø 40 mm ou Ø 63 mm
 PVC Rinne mit vertikalem Wasserablauf Ø 40 mm oder Ø 63 mm

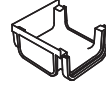

A055 100G*

Padana-Grid 10 pc/box 0,12 kg/pc

Angolo/incrocio a 3 o 4 vie in PVC con scarico verticale Ø 40 mm o Ø 80 mm **
 PVC corner/ T or X junction with vertical outlet Ø 40 mm o Ø 80 mm
 Angle/jonction en T ou en X en PVC avec évacuation verticale Ø 40 mm o Ø 80 mm
 PVC Ecke T oder X förmige Kreuzung Ø 40 mm o Ø 80 mm



T055 100G*

Padana-Grid 25 pc/box 0,05 kg/pc

Testata in PVC con scarico orizzontale Ø 50 mm **
 PVC stop-end with horizontal outlet Ø 50 mm
 About en PVC avec évacuation horizontale Ø 50 mm
 Endstück aus PVC mit horizontalem Wasserablauf Ø 50 mm

* Conservare al riparo dalla luce solare ed a temperature < 40°C
 Keep away from sunlight and store at temperatures < 40°C
 Conserver à l'abri du rayonnement solaire et à des températures < 40 °C
 Vor Sonnenlicht geschützt und bei Temperaturen < 40°C lagern

** Scarico da forare in cantiere (solo se necessario)
 Outlet to be drilled on the job site (only when necessary)
 Evacuation a percer en chantier (uniquement si nécessaire)
 Wasserablauf auf der Baustelle zu schneiden (erforderlichenfalls)

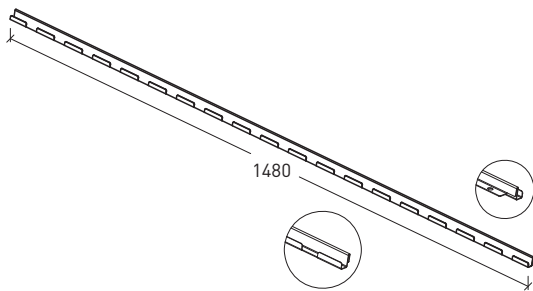

GK03 4A15***

Padana-Grid 1 pc/box 0,55 kg/pc

Profilo laterale inox per canaletta Pvc
 Stainless steel lateral profile for Pvc channel
 Profil latéral inox pour caniveau en Pvc
 Seitenprofile aus Edelstahl für Rinne aus Pvc

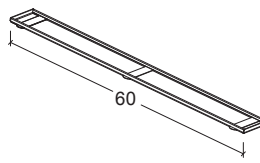

GK03 4B60***

Padana-Grid 1 pc/box 0,9 kg/pc

Vaschetta portapiastrelle inox
 Stainless steel tray for ceramic tiles
 Bac inox pour carreaux
 Fliesenträger aus Edelstahl

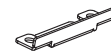

GK03-4CPP ***

Padana-Grid 1 pc/box 1,4 kg/pc

Testata per vaschetta inox
 Step end for stainless steel tray
 About pour bac inox
 Endstück für Fliesenträger aus Edelstahl

*** Articoli realizzati con acciaio inox AISI 316L-BA - EN 1.4404 (Lucido) / Classe di corrosività C4
 Items made with stainless steel AISI 316L-BA - EN 1.4404 (Polished) / Corrosion Class C4
 Références fabriquées en acier inox AISI 316L-BA - EN 1.4404 (Pol) / Catégorie de corrosivité C4
 Artikeln aus Edelstahl AISI 316L-BA - EN 1.4404 (Glanzend) / Korrosionsklasse C4

Mod.CP 003 - GK03 - Modulo 60

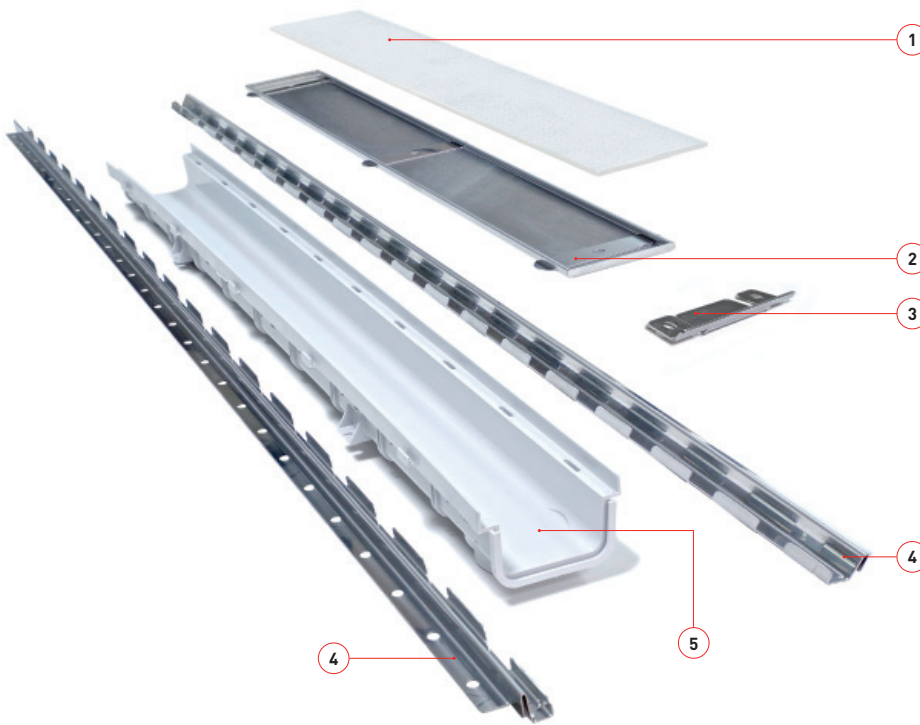

- 1 Piastrella [da tagliare in cantiere]
Ceramic tile (to be cut on job site)
Carreau céramique (à découper en chantier)
Fliese (auf der Baustelle zu schneiden)
- 2 GK03-4B60
- 3 GK03-4CPP
- 4 GK03-4A15
- 5 C055-100G

MINERAL CHROM - Naturale



AMAZZONIA - Grip



MARTE - Bocciardata



PIETRE DI SARDEGNA - Grip



CHALON -Grip A+B*



ECO CONCRETE - Grip



BOULDER - Grip A+B*



PETRA - Grip



* Superficie Grip A+B solo su richiesta
Surface Grip A+B on request only
Surface Grip A+B uniquement sur demande
Oberfläche Grip A+B nur auf Anfrage

Mod.CP 006

CANALETTE CON GRIGLIE DI COPERTURA CHANNELS WITH GRATINGS CANIVEAUX AVEC GRILLES RINNEN MIT ABDECKROSTE

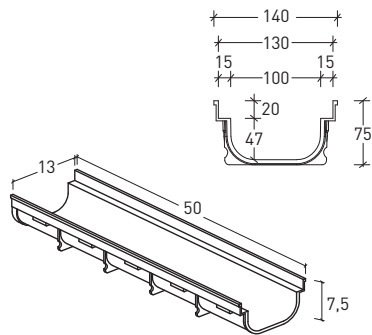

A075 130G*

Padana-Grid 10 pc/box 0,2 kg/pc

Angolo e giunto a 4 vie con scarico verticale Ø 90 mm o Ø 110 mm**
 Corner en X junction with vertical outlet Ø 90 mm or Ø 110 mm**
 Angle et jonction en X avec évacuation verticale Ø 90 mm ou Ø 110 mm**
 Ecke und X förmige Kreuzung mit vertikalem Wasserablauf Ø 90 mm oder Ø 110 mm**



T075 130G*

Padana-Grid 25 pc/box 0,05 kg/pc

Testata con scarico con scarico orizzontale Ø 40 mm**
 Stop end with outlet with horizontal outlet Ø 40 mm**
 About avec évacuation avec évacuation horizontale Ø 40 mm**
 Endstück mit Ablauf mit horizontalem Wasserablauf Ø 40 mm**

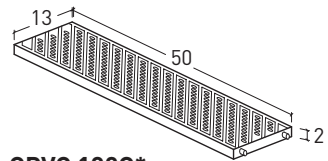

GPVC 130G*

Padana-Grid 1 pc/box 0,55 kg/pc

Griglia in Pvc
 Pvc grating
 Grille en Pvc
 Rost aus Pvc

C075 130G*

Padana-Grid 12 pc/box 0,6 kg/pc

Canaletta in PVC senza scarico
 PVC channel without outlet
 Caniveau en PVC sans évacuation
 PVC Rinne ohne Wasserablauf

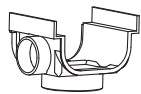

S075 130G*

Padana-Grid 25 pc/box 0,2 kg/pc

Giunto con doppio scarico laterale Ø 50 mm e scarico verticale Ø 80 mm**
 Insert with double lateral outlets Ø 50 mm and vertical outlet Ø 80 mm**
 Jonction avec double évacuation latéral Ø 50 mm et évacuation verticale Ø 80 mm**
 Stück mit doppel seitlichen Ablauf Ø 50 mm und vertikalem Wasserablauf Ø 80 mm**

* Conservare al riparo dalla luce solare ed a temperature < 40°C Keep away from sunlight and store at temperatures <40°C Conserver à l'abri du rayonnement solaire et à des températures <40 °C
 Vor Sonnenlicht geschützt und bei Temperaturen <40°C lagern

** Scarico da forare in cantiere (solo se necessario) Outlet to be drilled on the job site (only when necessary) Évacuation à percer en chantier (uniquement si nécessaire)
 Wasserablauf auf der Baustelle zu schneiden (erforderlichenfalls)

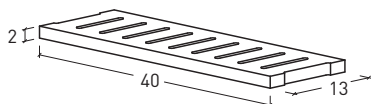

9885 (1)

Padana-Deck 8 pc/box 2,0 kg/pc

AMAZZONIA - Grip



COUNTRY WOOD - Grip



PIETRE DI SARDEGNA - Grip

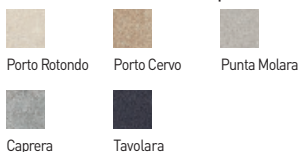

PIETRA BAUGÉ - Grip

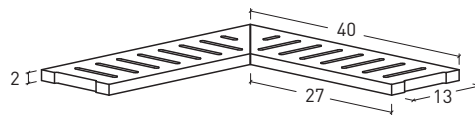

9886 (1)

Padana-Deck 2 pc 45° 4+4 pc/box 3,5 kg/pc

AMAZZONIA - Grip



COUNTRY WOOD - Grip



PIETRE DI SARDEGNA - Grip

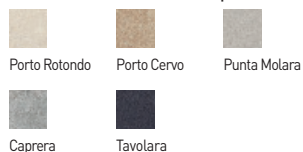

PIETRA BAUGÉ - Grip



(1) Consigliata solo per piscine private. Consigliata solo per canalette di spiaggia Suggested for private pools only. Recommended for deck channels only
 Conseillée uniquement pour piscines privées. Conseillée uniquement pour caniveaux de plage Nur für private Schwimmbäder. Nur für Strandrinnen empfohlen

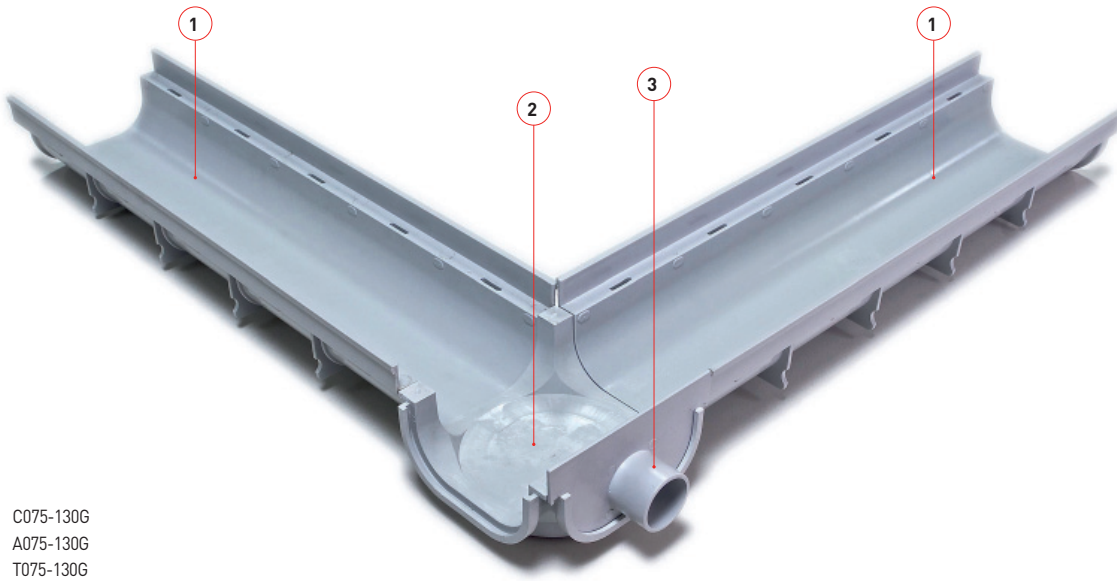

- 1 C075-130G
- 2 A075-130G
- 3 T075-130G

Mod.CP 006 - PVC

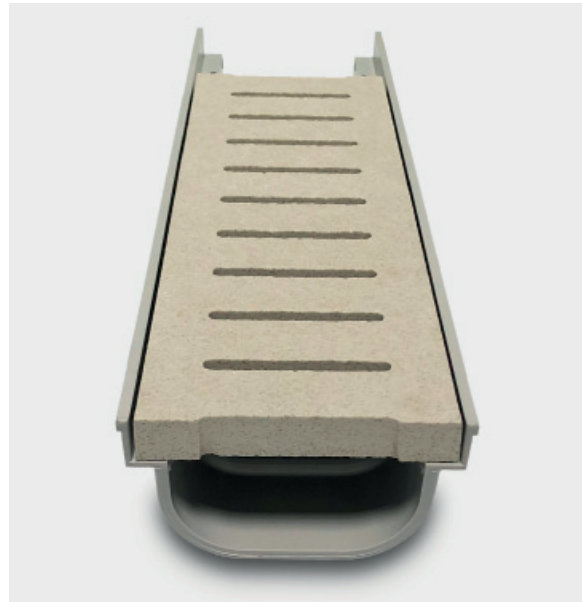

**BOCCHETTE DI SCARICO PER CANALETTE DI ESTERNO VASCA WATER OUTLETS FOR DECK CHANNELS EVACUATIONS CANIVEAUX DE PLAGE
WASSERÄBLÄUFE FÜR BECKENUMGÄNGSRINNEN**

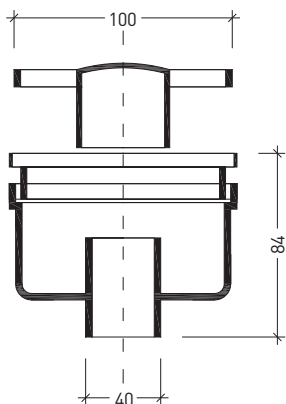

AS12 040G

Padana-Deck

Bocchetta in ABS grigio 100x100 mm con scarico verticale diametro 40 mm

Water outlet in ABS grey colour 100x100 mm with vertical drain pipe 40 mm diameter.

Siphon en ABS gris 100x100 mm avec évacuation verticale 40 mm diamètre.

Wasserablauf 100x100 mm aus grauem ABS mit vertikalem Ablauf 40 mm Durchmesser.

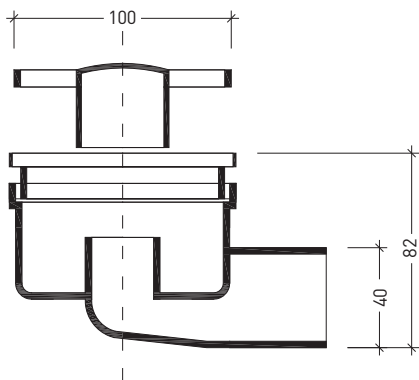

AS13 040G

Padana-Deck

Bocchetta in ABS grigio 100x100 mm con scarico orizzontale diametro 40 mm

Water outlet in ABS grey colour 100x100 mm with horizontal drain pipe 40 mm diameter.

Siphon en ABS gris 100x100 mm avec évacuation horizontale 40 mm diamètre.

Wasserablauf 100x100 mm aus grauem ABS mit horizontalem blauf 40 mm Durchmesser.

**BOCCHETTE DI SCARICO IMPERMEABILIZZATE PER CANALETTE DI ESTERNO VASCA WATERPROOFING WATER OUTLETS FOR DECK CHANNELS
EVACUATIONS ETANCHES POUR CANIVEAUX DE PLAGE ABGEDICHTETE WASSERABLÄUFE FÜR BECKENUMGANGSRINNEN**

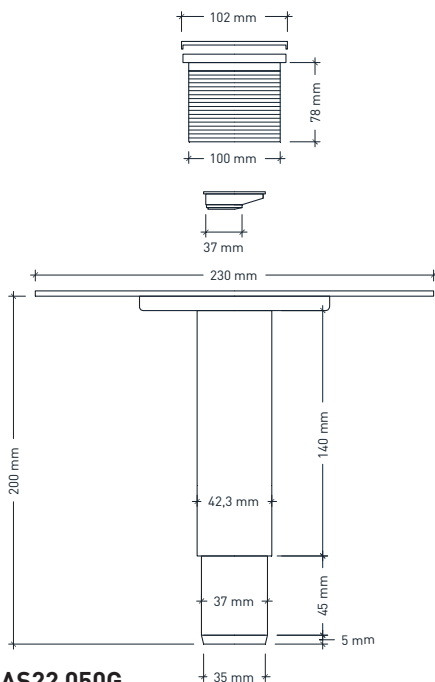
**AS22 050G**

Padana-Deck

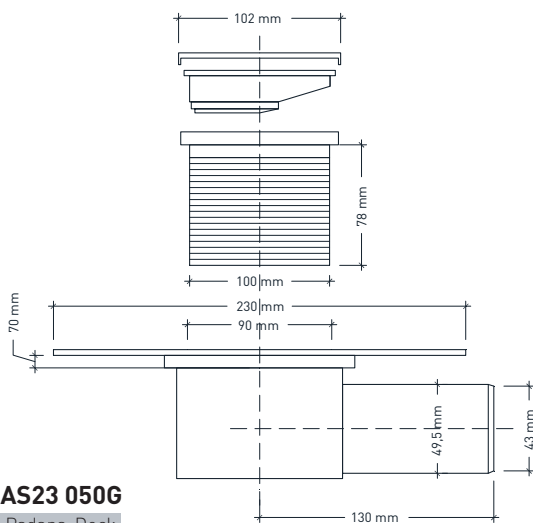
**AS23 050G**

Padana-Deck



Le bocchette di scarico AS22 050G (scarico verticale) e AS23 050G (scarico orizzontale) sono capaci di assicurare la continuità con l'impermeabilizzazione del pavimento circostante grazie al processo di termo fusione che unisce il telo impermeabile con la flangia della bocchetta. Entrambi i modelli sono dotati di scarico con diametro di 35 mm, della prolunga intagliabile per la gestione degli spessori, del tappo antiodore e della elegante griglia in acciaio inox AISI 304 100x100 mm.

The water outlets AS22 050G (vertical) and AS23 050G (horizontal) are able to ensure continuity of waterproofing on pool decks thanks to the waterproofing membrane duly connected with lower part of the outlets. Both models have are equipped with 35 mm drain pipe, with an adjustable extension to manage different thicknesses of concrete, with anti-odour -cap and with an elegant stainless steel grid AISI 304 100x100 mm.

Les siphons AS22 050G (vertical) et AS23 050G (horizontal), garantissent la continuité de l'étanchéité de la plage grâce à la membrane soudé à la partie inférieure des siphons. Les deux modèles sont équipés d'une sortie de 35 mm, d'un rallonge à couper par rapport à l'épaisseur de la chape, d'un coupe-odeurs et d'une élégante grille en acier inox AISI 304 100x100 mm.

Die Wasserabläufe AS22 050G (vertikal) und AS23 050G (horizontal) gewährleisten die Kontinuität mit der Abdichtung des umliegenden Bodens und dies der wasserdichten Membran dankend. Beide Typen sind ausgestattet mit Düse zu 35 mm Durchmesser, einstellbarer Verlängerung um unterschiedlichen Höhen zu regeln, Geruchskappe und eleganter Gitter aus Edelstahl AISI 304 100x100 mm.

Prodotti complementari

COMPLEMENTARY PRODUCTS
PRODUITS COMPLEMENTAIRES
ERGÄNZUNGSPRODUKTE

Nell'ampia gamma di Casalgrande Padana si possono individuare diversi prodotti adatti ai pavimenti e rivestimenti degli spazi pertinenti alla piscina come spogliatoi, docce, solarium o altre zone.

La selezione dei rivestimenti murali riguarda diverse collezioni e formati per offrire varianti di colore al programma specifico per piscine.

Per i pavimenti sono illustrati i prodotti della gamma Technic con valori antiscivolo a piedi nudi di Gruppo B (minimo necessario per le aree prevalentemente bagnate) e di Gruppo C (necessario per le aree prevalentemente immerse nell'acqua) misurati secondo la norma tedesca DIN 51097.

In questa sezione sono indicate soltanto le superfici che rientrano nei valori di antiscivolo sopra citati ed i minimali dei colori disponibili.

Per gli altri pavimenti che non devono avere un particolare valore antiscivolo si rimanda alla vasta gamma del catalogo generale di Casalgrande Padana.

Casalgrande Padana has a wide range of floor and wall products suitable to complementary swimming pool areas such as changing rooms, showers, tanning stations or other nonslip areas.

The range of wall claddings rests on several collections and sizes to offer additional colors options to the specific swimming pool range.

For floorings, this section includes the Technic range and only references rated group B (necessary for generally wet areas) and group C (normally submerged surfaces) barefoot, in accordance with German standard DIN 51097.

Here are reported only the surfaces whose anti-slip values are among those mentioned above and the available colours.

For floors that do not have to fulfil specific anti-slip values, please refer to the Casalgrande Padana general catalogue.

Casalgrande Padana dispose d'un large éventail de produits pour sols et murs des zones complémentaires des piscines, telles que vestiaires, douches, solariums ou autres surfaces antidérapantes.

L'éventail des revêtements muraux concerne plusieurs collections et format pour offrir des alternatives de couleur à la gamme spécifique pour piscines.

Pour les revêtements de sol, la sélection inclut la gamme Technic et ne comprend que les références qui ont un classement antidérapant pieds nus de groupe B (minimum nécessaire pour les surfaces habituellement mouillées) et de groupe C (pour les surfaces normalement immergées), conformément aux dispositions de la norme allemande DIN 51097.

Dans cette section, sont indiquées exclusivement les surfaces dont les valeurs antiglissance sont comprises parmi celles susmentionnées et les couleurs disponibles.

Pour tous les sols qui ne doivent pas respecter des valeurs anti-glissance spécifiques, consulter le catalogue général de Casalgrande Padana.

Im Sortiment von Casalgrande Padana kann man verschiedene Produkte finden, die für die Fußböden und Verkleidungen der zum Schwimmbad gehörenden Bereiche geeignet sind, wie Umkleidekabinen, Duschen, Sonnenstudios oder andere Bereiche mit Rutschgefahr.

Die Auswahl von Wandverkleidungen umfasst verschiedene Kollektionen und Formate, um Farbvariationen zum spezifischen Programm für Schwimmbäder anzubieten.

Für die Fußböden werden die Produkte der Serie Technic mit Rutschfestigkeitskoeffizienten der Gruppe B bei barfüßigem Betreten illustriert (erforderlicher Mindestwert für überwiegend feuchte Bereiche) und der Gruppe C (erforderlicher Mindestwert für überwiegend unter Wasser liegende Bereiche), die entsprechend der deutschen Norm DIN 51097 gemessen werden.

In diesen Bereich sind nur die Oberflächen aufgenommen, die den oben erwähnten Rutschfestigkeitskoeffizienten entsprechen, sowie die Mindestauswahl der verfügbaren Farben.

Für sonstige Fußböden, die keinen besonderen Rutschfestigkeitskoeffizienten erforderlich machen, wird auf das breite Sortiment des allgemeinen Katalogs von Casalgrande Padana verwiesen.



Brickworks







NUANCES









			
Neve Lux	Cameo Lux	Tundora Lux	Petunia Nera Lux
			
Neve Satin	Cameo Satin	Tundora Satin	Petunia Nera Satin
			
Mercurio Lux	Aliseo Lux	Blu Sherpa Lux	Verde Persia Lux
			
Mercurio Satin	Aliseo Satin	Blu Sherpa Satin	Verde Persia Satin

MURETTO

		
Muretto Nero	Muretto Grigio	Muretto Bianco
		
Muretto Lava	Muretto Calce	Muretto Mattone

PETRA

		
Petra Antracite	Petra Grigia	Petra Bianca
		
Petra Oro	Petra Sabbia	Petra Perla

	NUANCES	MURETTO	PETRA
Formati Sizes Formats Formate	 cm 8,2x25 3 1/4" x 9 7/8"	 cm 8,2x25 3 1/4" x 9 7/8"	 cm 8,2x25 3 1/4" x 9 7/8"
Superfici Surfaces Surfaces Oberflächen	 		
	mm 9	mm 9	mm 9

-  Lucida
-  Satin
-  Naturale



Atelier



Rubino

Ottanio

Fiordaliso

Lavanda



Uniforme
Uniform
Uniforme
Einheitliche

Vedi pagina: See page:
Voir page: Siehe Seite: **237**

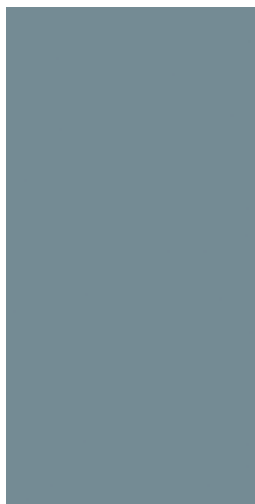

Indaco



Oltremare



Brume

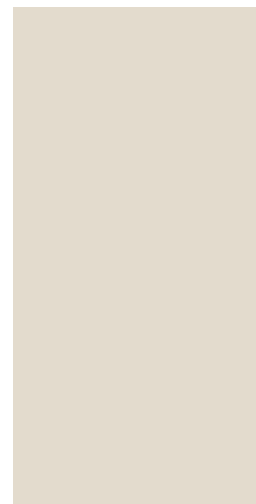

Cristallo

K Grandi lastre K_{ontinua}
K_{ontinua} Big slabs
Grandes dalles K_{ontinua}
K_{ontinua} Grobe Platten



cm 40x120
15³/₄"x47¹/₄"



cm 60x120
23⁵/₈"x47¹/₄"



cm 120x120
47¹/₄"x47¹/₄"

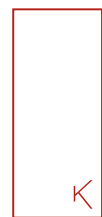

cm 120x278
47¹/₄"x109¹/₂"

Formati Sizes
Formats Formate

Superfici Surfaces
Surfaces Oberflächen



mm 6,5

mm 6,5

mm 6,5

mm 6,5

● Naturale

Rettificate in un unico calibro Rectified version in a single caliber Rectifiés en un unique calibre Boden Sie in einem einzigen Kaliber

Negli ambienti ad alto traffico si consiglia l'uso solo a rivestimento In high-footfall settings, it is advisable to use these tiles only as wall coverings Dans les espaces à forte circulation, il est conseillé de l'utiliser uniquement comme revêtement de mur In stark beanspruchten Bereichen wird nur eine Verwendung als Verkleidung empfohlen

Altre superfici e formati da definire su richiesta per utilizzo a pavimento Other surfaces and sized to be defined on request for floors Autres finitions et formats à définir sur demande pour des revêtements de sol Andere Flächen und Größen sind auf Anfrage für die Bodenverlegung zu definieren



Caleidoscopio



Uniforme
Uniform
Uniforme
Einheitliche

Vedi pagina: See page: Voir page: Siehe Seite: 237

Formati Sizes
Formats Formate



cm 20x20
7⁷/₈" x 7⁷/₈"

Superfici Surfaces
Surfaces Oberflächen



mm 7,3

● Naturale



Technic

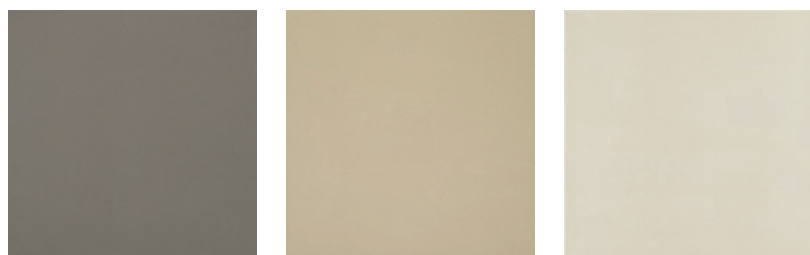

Grigio Cenere

Bianco Avorio









Bianco B



Nebraska

Arkansas



Ontario

Formati Sizes Formats Formate	 cm 20x20 7 ⁷ / ₈ "x7 ⁷ / ₈ "	 cm 20x20 7 ⁷ / ₈ "x7 ⁷ / ₈ "	 cm 20x20 7 ⁷ / ₈ "x7 ⁷ / ₈ "	 cm 12,5x25 4 ⁷ / ₈ "x9 ⁷ / ₈ "	 cm 30x30 11 ³ / ₄ "x11 ³ / ₄ "	 cm 30x30 11 ³ / ₄ "x11 ³ / ₄ "	 cm 30x30 11 ³ / ₄ "x11 ³ / ₄ "
Unicolore Grigio Cenere	● ● ● ● ●	● ● ● ● ●	● ● ● ● ●		●	●	●
Unicolore Bianco Avorio	● ● ● ● ● ●	● ● ● ● ● ●	● ● ● ● ● ●		● ●	● ●	● ●
Unicolore Bianco B	● ● ● ● ●	● ● ● ● ●	● ● ● ● ●		● ●	● ●	● ●
Granito 1 Ontario	● ● ● ● ●	● ● ● ● ●	● ● ● ● ●		● ●	● ●	● ●
Granito 1 Nebraska	● ● ● ● ● ●	● ● ● ● ● ●	● ● ● ● ● ●		● ●	● ●	● ●
Granito 1 Arkansas	● ● ● ● ● ●	● ● ● ● ● ●	● ● ● ● ● ●	● ●	● ●	● ●	● ●
	mm 8	mm 12	mm 14	mm 8	mm 8	mm 11,2	mm 14

- Roccia
- Bugnato
- Profil
- Pavé
- Secura
- Reticolo



pavimenti antiscivolo / non slip floor tiles / carreaux de sols antiderapants / trittsichere bodenplatten

● Secura

DIN 51097 B	XP P 05-010 PN 18	
DIN 51130 R 11	XP P 05-010 PC 20	





● Roccia

DIN 51097 B	XP P 05-010 PN 18	
DIN 51130 R 11	XP P 05-010 PC 20	





● Pavé

DIN 51097 C	XP P 05-010 PN 24	
DIN 51130 R 11 V 4	XP P 05-010 PC 20	



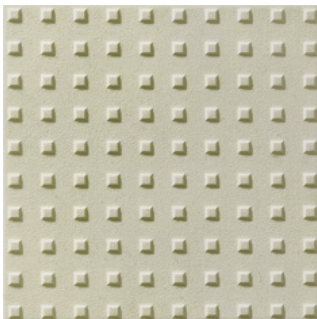

● Bugnato

DIN 51097 C	XP P 05-010 PN 24	
DIN 51130 R 11 V 6	XP P 05-010 PC 20	



● Reticolo

DIN 51097 C	XP P 05-010 PN 24	
DIN 51130 R 12 V 4	XP P 05-010 PC 27	



● Profil

DIN 51097 C	XP P 05-010 PN 24	
DIN 51130 R 12 V 8	XP P 05-010 PC 27	

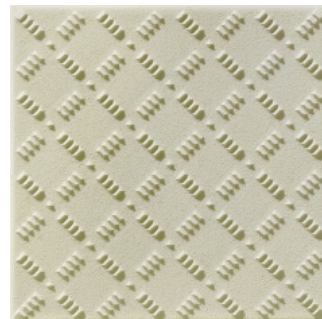

TECH INFO

CARATTERISTICHE TECNICHE

TECHNICAL FEATURES

CARACTERISTIQUES TECHNIQUES

TECHNISCHE EIGENSCHAFTEN

Caratteristiche tecniche

TECHNICAL FEATURES / CARACTERISTIQUES TECHNIQUES / TECHNISCHE EIGENSCHAFTEN

GRANITOGRES



NORMA STANDARDS NORME NORM

	classificazione prodotto product classification classement Klassifizierung	UNI EN 14411-G ISO 13006
	caratteristiche dimensionali e d'aspetto dimensional and surface quality caractéristiques de la surface Oberflächenqualität	UNI EN ISO 10545-2
	assorbimento di acqua water absorption absorption d'eau Wasseraufnahme	UNI EN ISO 10545-3
	resistenza alla flessione flexural strength résistance à la flexion Biegezug-Festigkeit	UNI EN ISO 10545-4
	resistenza al gelo frost resistance résistance au gel Frostwiderstandsfähigkeit	qualsiasi norma all standards toute norme Alle normen
	resistenza attacco chimico (esclusione acido fluoridrico) resistance to acids and alkalis (with the exception of hydrofluoric acid) résistance à l'attaque chimique (exclusion de l'acide fluorhydrique) Säure und Laugen Beständigkeit (mit Ausnahme von Fluorwasserstoff)	UNI EN ISO 10545-13
	resistenza usura e abrasione wear and abrasion resistance résistance à l'usure et abrasion Abriebhärte	UNI EN ISO 10545-6
	dilatazione termica lineare linear thermal expansion coefficient linéaire de dilatation thermique Lineare Wärmeausdehnung	UNI EN ISO 10545-8
	resistenza alle macchie stain resistance résistance aux taches Fleckenfestigkeit	UNI EN ISO 10545-14
	resistenza alla scivolosità (Superficie Naturale) slip resistance (Matt surface) résistance au glissement (Surface naturelle) Trittsicherheit (Natur Oberflächen)	DIN 51130 D.M. N° 236 del 14.06.89 Metodo B.C.R. BS7976-2:2002 BSEN13036-4:2011
	resistenza dei colori alla luce colour resistance to sunlight exposure résistance de la couleur à la lumière Unveränderlichkeit der Farben wenn Strahlung zugesetzt wird	DIN 51094

* Valore indicativo Approx value donnée approximative Ungefähre Werte

** Prova su superficie asciutta Test on a dry surface Essai sur surface sèche Test auf trockener Oberfläche

◆ Si rimanda all'elenco prodotti UPEC ufficiale, consultabile sul sito: Please see the official UPEC product list: Veuillez consulter la liste officielle produits UPEC: Siehe die offizielle UPEC-Produktliste auf der Website: <http://webapp.cstb.fr/upec-ceramique/>

Al pari dei materiali naturali di riferimento, l'aspetto estetico, la differenza di tono e le venature possono essere diverse da piastrella a piastrella. Per una corretta comprensione della variabilità del prodotto è consigliabile prendere visione delle immagini a tutto ambiente sul catalogo di collezione, sul nostro sito all'indirizzo www.casalgrandepadana.it o chiedere maggiori informazioni ai nostri concessionari.

Just like the natural materials they are inspired by, the aesthetics, colouration and veining of the tiles can differ. To properly gauge the suitability of a product, we advise that you view the full-space photos that you can find in our collection catalogue and on our website at www.casalgrandepadana.com. Alternatively, please ask a reseller for more information.

Tout comme pour les matières naturelles de référence, la différence de tonalité, les veines ainsi que l'aspect esthétique peuvent varier d'une dalle à l'autre. Pour bien comprendre la variabilité du produit, il est conseillé de consulter les images d'ambiance présentes sur le catalogue de la collection, sur notre site à l'adresse www.casalgrandepadana.fr ou de demander plus d'informations à nos concessionnaires.

Wie bei den als Vorbild dienenden Naturmaterialien können sich auch hier das ästhetische Erscheinungsbild, der Farbtonunterschied und die Maserung von Fliese zu Fliese unterscheiden. Um die Variabilität des Produkts besser zu verstehen, raten wir Ihnen, die Bilder mit ausgestatteten Räumen im Kollektionskatalog auf unserer Website www.casalgrandepadana.de zu konsultieren. Weitere Informationen können Sie auch bei unseren Vertragshändlern erhalten.

caratteristiche tecniche / technical features / caractéristiques techniques / technische eigenschaften



RISULTATO PROVA* TEST RESULTS* RESULTATS DES ESSAIS* ERGEBNISSWE*	NORMA ASTM ASTM STANDARDS	RISULTATO PROVA TEST RESULTS RESULTATS DES ESSAIS ERGEBNISSE
gruppo B1a UGL completamente greificato group B1a UGL fully vitrified group B1a UGL grès cérame fin Gruppe B1a UGL Feinsteinzeug		
tolleranze minime nella 1ª scelta very low tolerance des tolérances minimales en 1er choix Entspricht Normen		
< 0,1%	ASTM C-373 impervious ≤ 0,5%	< 0,1%***
> 45 N/mm ²	ASTM C-648 breaking strength ≥ 250 lbf	425 lbf*** 625 lbf****
garantita guaranteed garantie Frostsicher	ASTM C-1026 no sample must show alterations to surface	resistant
A	ASTM C-650 no sample must show alterations to surface	unaffected
≤ 150 mm ³	ASTM C-1243 < 175 mm ³	≤ 150 mm ³
6 x 10 ⁻⁶		
garantita guaranteed garantie garantiert		
vedere singole serie see every series voir les séries une par une Siehe einzelne Serie	ASTM A137.1-2012 DCOF ≥ 0.42	see every series
valore μ > 0,40**		
PTV > 36**		
nessuna variazione no change of colours couleurs inchangées Keinerlei Farbänderung		

*** Test made on Granito 1, Arizona Matt

**** Test made on Marte Series

Caratteristiche tecniche

TECHNICAL FEATURES / CARACTERISTIQUES TECHNIQUES / TECHNISCHE EIGENSCHAFTEN







GRESPLUS



NORMA STANDARDS NORME NORM

RISULTATO PROVA* TEST RESULTS* RESULTATS DES ESSAIS* ERGEBNISSE*

	classificazione prodotto product classification classement Klassifizierung	UNI EN 14411-G ISO 13006	gruppo B1a completamente greificato group B1a fully vitrified group B1a grès cérame fin Gruppe B1a Feinsteinzeug
	caratteristiche dimensionali e d'aspetto dimensional and surface quality caractéristiques de la surface Oberflächenqualität	UNI EN ISO 10545-2	tolleranze minime nella 1ª scelta very low tolerance des tolérances minimales en 1er choix Entspricht Normen
	assorbimento di acqua water absorption absorption d'eau Wasseraufnahme	UNI EN ISO 10545-3	< 0,1%
	resistenza alla flessione flexural strength résistance à la flexion Biegezug-Festigkeit	UNI EN ISO 10545-4	> 45 N/mm ²
	resistenza al gelo frost resistance résistance au gel Frostwiderstandsfähigkeit	qualsiasi norma all standards toute norme Alle normen	garantita guaranteed garantie Frostsicher
	resistenza attacco chimico (esclusione acido fluoridrico) resistance to acids and alkalis (with the exception of hydrofluoric acid) résistance à l'attaque chimique (exclusion de l'acide fluorhydrique) Säure und Laugen Beständigkeit (mit Ausnahme von Fluorwasserstoff)	UNI EN ISO 10545-13	A
	resistenza usura e abrasione wear and abrasion résistance résistance à l'usure et abrasion Abriebhärte	UNI EN ISO 10545-6	≤ 150 mm ³
	dilatazione termica lineare linear thermal expansion coefficient linéaire de dilatation thermique Lineare Wärmeausdehnung	UNI EN ISO 10545-8	6 x 10 ⁻⁶
	resistenza alle macchie stain resistance résistance aux taches Fleckenfestigkeit	UNI EN ISO 10545-14	garantita guaranteed garantie garantiert
	resistenza alla scivolosità (Superficie Naturale) slip resistance (Matt surface) résistance au glissement (Surface naturelle) Trittsicherheit (Natur Oberflächen)	DIN 51130 D.M. N° 236 del 14.06.89 Metodo B.C.R. BS7976-2:2002 BSEN13036-4:2011	vedere singole serie see every series voir les séries une par une Siehe einzelne Serie valore $\mu > 0,40^{**}$ PTV > 36 ^{**}
	resistenza dei colori alla luce colour resistance to sunlight exposure résistance de la couleur à la lumière Unveränderlichkeit der Farben wenn Strahlung zugesetzt wird	DIN 51094	nessuna variazione no change of colours couleurs inchangées Keinerlei Farbänderung

* Valore indicativo Approx value donnée approximative Ungefähre Werte

** Prova su superficie asciutta Test on a dry surface Essai sur surface sèche Test auf trockener Oberfläche

◆ Si rimanda all'elenco prodotti UPEC ufficiale, consultabile sul sito: Please see the official UPEC product list: Veuillez consulter la liste officielle produits UPEC:
Sihe die offizielle UPEC-Produktliste auf der Website: <http://webapp.cstb.fr/upec-ceramique/>

Al pari dei materiali naturali di riferimento, l'aspetto estetico, la differenza di tono e le venature possono essere diverse da piastrella a piastrella.
Per una corretta comprensione della variabilità del prodotto è consigliabile prendere visione delle immagini a tutto ambiente sul catalogo di collezione, sul nostro sito all'indirizzo www.casalgrandepadana.it o chiedere maggiori informazioni ai nostri concessionari.

Just like the natural materials they are inspired by, the aesthetics, colouration and veining of the tiles can differ. To properly gauge the suitability of a product, we advise that you view the full-space photos that you can find in our collection catalogue and on our website at www.casalgrandepadana.com. Alternatively, please ask a reseller for more information.

Tout comme pour les matières naturelles de référence, la différence de tonalité, les veines ainsi que l'aspect esthétique peuvent varier d'une dalle à l'autre.
Pour bien comprendre la variabilité du produit, il est conseillé de consulter les images d'ambiance présentes sur le catalogue de la collection, sur notre site à l'adresse www.casalgrandepadana.fr ou de demander plus d'informations à nos concessionnaires.











Wie bei den als Vorbild dienenden Naturmaterialien können sich auch hier das ästhetische Erscheinungsbild, der Farbtonunterschied und die Maserung von Fliese zu Fliese unterscheiden. Um die Variabilität des Produkts besser zu verstehen, raten wir Ihnen, die Bilder mit ausgestatteten Räumen im Kollektionskatalog auf unserer Website www.casalgrandepadana.de zu konsultieren. Weitere Informationen können Sie auch bei unseren Vertragshändlern erhalten.



PIETRE NATIVE

NORMA STANDARDS NORME NORM

RISULTATO PROVA* TEST RESULTS* RESULTATS DES ESSAIS* ERGEBNISSWE*

	classificazione prodotto product classification classement Klassifizierung	UNI EN 14411-G ISO 13006	gruppo B1a completamente greificato group B1a fully vitrified group B1a grès cérame fin Gruppe B1a Feinsteinzeug
	caratteristiche dimensionali e d'aspetto dimensional and surface quality caractéristiques de la surface Oberflächenqualität	UNI EN ISO 10545-2	tolleranze minime nella 1ª scelta very low tolerance des tolérances minimes en 1er choix Entspricht Normen
	assorbimento di acqua water absorption absorption d'eau Wasseraufnahme	UNI EN ISO 10545-3	< 0,1%
	resistenza alla flessione flexural strength résistance à la flexion Biegezug-Festigkeit	UNI EN ISO 10545-4	> 45 N/mm ²
	resistenza al gelo frost resistance résistance au gel Frostwiderstandsfähigkeit	qualsiasi norma all standards toute norme Alle normen	garantita guaranteed garantie Frostsicher
	resistenza attacco chimico (esclusione acido fluoridrico) resistance to acids and alkalis (with the exception of hydrofluoric acid) résistance à l'attaque chimique (exclusion de l'acide fluorhydrique) Säure und Laugen Beständigkeit (mit Ausnahme von Fluorwasserstoff)	UNI EN ISO 10545-13	A
	resistenza usura e abrasione wear and abrasion résistance résistance à l'usure et abrasion Abriebhärte	UNI EN ISO 10545-6	≤ 150 mm ³
	dilatazione termica lineare linear thermal expansion coefficient linéaire de dilatation thermique Lineare Wärmeausdehnung	UNI EN ISO 10545-8	6 x 10 ⁻⁶
	resistenza alle macchie stain resistance résistance aux taches Fleckenfestigkeit	UNI EN ISO 10545-14	garantita guaranteed garantie garantiert
	resistenza alla scivolosità (Superficie Naturale) slip resistance (Matt surface) résistance au glissement (Surface naturelle) Trittsicherheit (Natur Oberflächen)	DIN 51130 D.M. N° 236 del 14.06.89 Metodo B.C.R. BS7976-2:2002 BSEN13036-4:2011	vedere singole serie see every series voir les séries une par une Siehe einzelne Serie valore μ > 0,40** PTV > 36**
	resistenza dei colori alla luce colour resistance to sunlight exposure résistance de la couleur à la lumière Unveränderlichkeit der Farben wenn Strahlung zugesetzt wird	DIN 51094	nessuna variazione no change of colours couleurs inchangées Keinerlei Farbänderung

* Valore indicativo Approx value donnée approximative Ungefähre Werte

** Prova su superficie asciutta Test on a dry surface Essai sur surface sèche Test auf trockener Oberfläche

◆ Si rimanda all'elenco prodotti UPEC ufficiale, consultabile sul sito: Please see the official UPEC product list: Veuillez consulter la liste officielle produits UPEC: Sihe die offizielle UPEC-Produktliste auf der Website: <http://webapp.cstb.fr/upec-ceramique/>

Al pari dei materiali naturali di riferimento, l'aspetto estetico, la differenza di tono e le venature possono essere diverse da piastrella a piastrella. Per una corretta comprensione della variabilità del prodotto è consigliabile prendere visione delle immagini a tutto ambiente sul catalogo di collezione, sul nostro sito all'indirizzo www.casalgrandepadana.it o chiedere maggiori informazioni ai nostri concessionari.

Just like the natural materials they are inspired by, the aesthetics, colouration and veining of the tiles can differ. To properly gauge the suitability of a product, we advise that you view the full-space photos that you can find in our collection catalogue and on our website at www.casalgrandepadana.com. Alternatively, please ask a reseller for more information.













Tout comme pour les matières naturelles de référence, la différence de tonalité, les veines ainsi que l'aspect esthétique peuvent varier d'une dalle à l'autre. Pour bien comprendre la variabilité du produit, il est conseillé de consulter les images d'ambiance présentes sur le catalogue de la collection, sur notre site à l'adresse www.casalgrandepadana.fr ou de demander plus d'informations à nos concessionnaires.

Wie bei den als Vorbild dienenden Naturmaterialien können sich auch hier das ästhetische Erscheinungsbild, der Farbtonunterschied und die Maserung von Fliese zu Fliese unterscheiden. Um die Variabilität des Produkts besser zu verstehen, raten wir Ihnen, die Bilder mit ausgestatteten Räumen im Kollektionskatalog auf unserer Website www.casalgrandepadana.de zu konsultieren. Weitere Informationen können Sie auch bei unseren Vertragshändlern erhalten.

Caratteristiche tecniche

TECHNICAL FEATURES / CARACTERISTIQUES TECHNIQUES / TECHNISCHE EIGENSCHAFTEN



	GRANITOKER		NORMA STANDARDS NORME NORM	RISULTATO PROVA* TEST RESULTS* RESULTATS DES ESSAIS* ERGEBNISSE*
	classificazione prodotto product classification classement Klassifizierung		UNI EN 14411-G ISO 13006	gruppo B1a completamente greificato group B1a fully vitrified group B1a grès cérame fin Gruppe B1a Feinsteinzeug
	caratteristiche dimensionali e d'aspetto dimensional and surface quality caractéristiques de la surface Oberflächenqualität		UNI EN ISO 10545-2	tolleranze minime nella 1ª scelta very low tolerance des tolérances minimales en 1er choix Entspricht Normen
	assorbimento di acqua water absorption absorption d'eau Wasseraufnahme		UNI EN ISO 10545-3	< 0,1%
	resistenza alla flessione flexural strength résistance à la flexion Biegezug-Festigkeit		UNI EN ISO 10545-4	> 45 N/mm ²
	resistenza al gelo frost resistance résistance au gel Frostwiderstandsfähigkeit		qualsiasi norma all standards toute norme Alle normen	garantita guaranteed garantie Frostsicher
	resistenza attacco chimico (esclusione acido fluoridrico) resistance to acids and alkalis (with the exception of hydrofluoric acid) résistance à l'attaque chimique (exclusion de l'acide fluorhydrique) Säure und Laugen Beständigkeit (mit Ausnahme von Fluorwasserstoff)		UNI EN ISO 10545-13	A
	resistenza usura e abrasione wear and abrasion résistance résistance à l'usure et abrasion Abriebhärte		UNI EN ISO 10545-6	≤ 150 mm ³
	dilatazione termica lineare linear thermal expansion coefficient linéaire de dilatation thermique Lineare Wärmeausdehnung		UNI EN ISO 10545-8	6 x 10 ⁻⁶
	resistenza alle macchie stain resistance résistance aux taches Fleckenfestigkeit		UNI EN ISO 10545-14	garantita guaranteed garantie garantiert
	resistenza alla scivolosità (Superficie Naturale) slip resistance (Matt surface) résistance au glissement (Surface naturelle) Trittsicherheit (Natur Oberflächen)		DIN 51130 D.M. N° 236 del 14.06.89 Metodo B.C.R. BS7976-2:2002 BSEN13036-4:2011	vedere singole serie see every series voir les séries une par une Siehe einzelne Serie valore μ > 0,40** PTV > 36**
	resistenza dei colori alla luce colour resistance to sunlight exposure résistance de la couleur à la lumière Unveränderlichkeit der Farben wenn Strahlung zugesetzt wird		DIN 51094	nessuna variazione no change of colours couleurs inchangées Keinerlei Farbänderung

* Valore indicativo Approx value donnée approximative Ungefähre Werte

** Prova su superficie asciutta Test on a dry surface Essai sur surface sèche Test auf trockener Oberfläche

◆ Si rimanda all'elenco prodotti UPEC ufficiale, consultabile sul sito: Please see the official UPEC product list: Veuillez consulter la liste officielle produits UPEC: Sihe die offizielle UPEC-Produktliste auf der Website: <http://webapp.cstb.fr/upec-ceramique/>

Al pari dei materiali naturali di riferimento, l'aspetto estetico, la differenza di tono e le venature possono essere diverse da piastrella a piastrella. Per una corretta comprensione della variabilità del prodotto è consigliabile prendere visione delle immagini a tutto ambiente sul catalogo di collezione, sul nostro sito all'indirizzo www.casalgrandepadana.it o chiedere maggiori informazioni ai nostri concessionari.

Just like the natural materials they are inspired by, the aesthetics, colouration and veining of the tiles can differ. To properly gauge the suitability of a product, we advise that you view the full-space photos that you can find in our collection catalogue and on our website at www.casalgrandepadana.com. Alternatively, please ask a reseller for more information.

Tout comme pour les matières naturelles de référence, la différence de tonalité, les veines ainsi que l'aspect esthétique peuvent varier d'une dalle à l'autre. Pour bien comprendre la variabilité du produit, il est conseillé de consulter les images d'ambiance présentes sur le catalogue de la collection, sur notre site à l'adresse www.casalgrandepadana.fr ou de demander plus d'informations à nos concessionnaires.

Wie bei den als Vorbild dienenden Naturmaterialien können sich auch hier das ästhetische Erscheinungsbild, der Farbtonunterschied und die Maserung von Fliese zu Fliese unterscheiden. Um die Variabilität des Produkts besser zu verstehen, raten wir Ihnen, die Bilder mit ausgestatteten Räumen im Kollektionskatalog auf unserer Website www.casalgrandepadana.de zu konsultieren. Weitere Informationen können Sie auch bei unseren Vertragshändlern erhalten.

caratteristiche tecniche / technical features / caractéristiques techniques / technische eigenschaften
variazioni cromatiche / chromatic variations / variations chromatiques / farbtonabweichungen

Variazioni cromatiche

CHROMATIC VARIATIONS / VARIATIONS CHROMATIQUES / FARBTONABWEICHUNGEN

Indica il livello di variazione cromatica che sussiste all'interno della stessa collezione fra una piastrella e l'altra.

The scale denotes the level of colour variation that exists between specific tiles in the same collection.

C'est le degré de variation chromatique qui existe entre un carreau et un autre de la même collection.

Das zeigt die Einstufung der chromatischen Variation, die innerhalb den verschiedenen Fliesen der selben Kollektion entsteht.

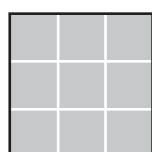

Uniforme
Uniform
Uniforme
Einheitliche

V1

L'aspetto delle piastrelle è uniforme. Differenze minime fra i prodotti appartenenti al medesimo lotto produttivo.

The appearance of the tiles is uniform. There are minimal differences in products belonging to the same production batch.

L'aspect des carreaux est uniforme. Les différences entre les produits appartenant à un même lot de production sont minimales.

Der optische Aspekt der Fliesen ist einheitlich. Die Unterschiede zwischen Produkten derselben Produktionscharge sind minimal.

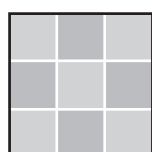

Leggera
Minimal
Légère
Leichte

V2

L'aspetto delle piastrelle presenta leggere ma visibili differenze, che si tratti di segni grafici o sfumature/venature tipiche del materiale naturale di riferimento.

There are subtle yet visible differences in the appearance of the tile, whether these are clear markings or the typical shading/veining of the natural material in question.

L'aspect des carreaux présente des différences légères mais visibles, qu'il s'agisse de marques graphiques ou de nuances/veinures typiques du matériau naturel de référence.

Der optische Aspekt der Fliesen weist leichte aber sichtbare Unterschiede auf, wobei es sich um graphische Zeichnungen oder Schattierungen/Maserungen handelt, die für das natürliche Referenzmaterial typisch sind.

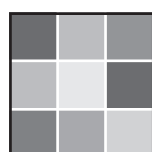

Media
Medium
Modérée
Mittlere

V3

L'aspetto delle piastrelle presenta variazioni di colore e/o struttura decisi. Questa variabilità cromatica è appositamente studiata in fase di progettazione della collezione per rendere il prodotto il più vicino possibile al materiale naturale di riferimento.

There are clear variations in the colour and/or structure of the tiles. This dynamic colour variation is meticulously planned during the collection design phase in order to make the product as similar as possible to the natural material in question.

L'aspect des carreaux présente des variations de couleur et/ou de structure marquées. Le caractère variable de la couleur est spécialement étudié lors de la conception de la collection pour rendre le produit le plus proche possible du matériau naturel de référence.

Der optische Aspekt der Fliesen weist deutliche Farb- und/oder Strukturunterschiede auf. Diese chromatische Variabilität wurde in der Designphase der Kollektion speziell entwickelt, um das Produkt seinem natürlichen Referenzmaterial so ähnlich wie möglich zu machen.



Accentuata
Accentuated
Importante
Starke

V4

L'aspetto delle piastrelle presenta variazioni importanti di colore e/o di struttura, rendendole, in alcuni casi, completamente diverse tra loro.

There are significant variations in the colour and/or structure of the tiles. In some cases, one tile can appear completely different to the next.

L'aspect des carreaux présente d'importantes variations de couleur et/ou de structure, ce qui les rend, dans certains cas, complètement différentes entre elles.

Der optische Aspekt der Fliesen weist bedeutende Farb- und/oder Strukturunterschiede auf, durch die sie sich in einigen Fällen vollständig voneinander abheben.

Mosaici

MOSAICS / MOSAÏQUE / MOSAIKEN

MOSAICO CON RETE DAVANTI MOSAIC WITH NET ON GOOD FACE MOSAÏQUE AVEC TRAME SUR BELLE FACE GELIEFERT MIT NETZ AUF DER VORDERSEITE

Adatto sia per zone secche e zone umide
Suited both for dry and humid zones
Adaptée soit pour zones sèches soit pour zones humides
Geeignet für trockene und nasse Oberflächen

Davanti del foglio
Front view of the sheet
Devant de la plaque
Vorderer Teil des Blattes

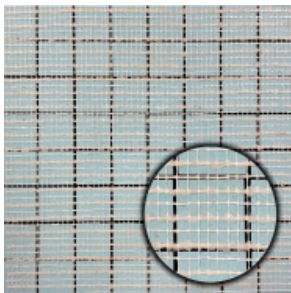

Retro del foglio
Back view of the sheet
Arrière de la plaque
Hinterer Teil des Blattes

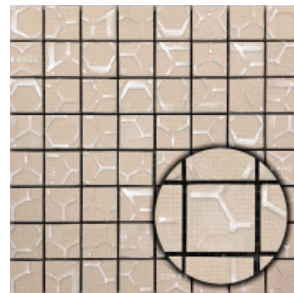

MOSAICO SU RETE MOSAIC ON NET MOSAÏQUE SUR TRAME MOSAÏK AUF NETZ

Consigliato soltanto per zone secche
Suggested for dry zones only
Suggérée uniquement pour zones sèches
Geeignet für trockene und nasse Oberflächen

Davanti del foglio
Front view of the sheet
Devant de la plaque
Vorderer Teil des Blattes

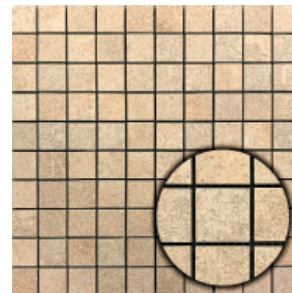

Retro del foglio
Back view of the sheet
Arrière de la plaque
Hinterer Teil des Blattes

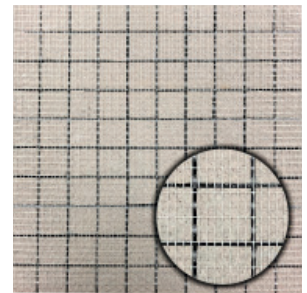

Una volta estratti dalle scatole, i fogli devono essere maneggiati con cura, senza scuoterli eccessivamente
Once out of the boxes the sheets must be handled with care, avoiding to shake them excessively
Dès que les plaques ont été retirées des boîtes, il faut les manipuler avec précaution, sans les agiter excessivement
Sobald sie aus den Boxen extrahiert werden, müssen die Blätter mit Sorgfalt behandelt werden, ohne sie übermäßig zu schütteln

MOSAICO CON RETE DAVANTI - ISTRUZIONI D'USO MOSAIC WITH NET ON GOOD FACE - INSTRUCTIONS FOR USE MOSAÏQUE AVEC TRAME SUR BELLE FACE - NOTICE D'UTILISATION GELIEFERT MIT NETZ AUF DER VORDERSEITE - GEBRAUCHSANWEISUNGEN

- Procedere con il normale incollaggio dei fogli di mosaico e attendere il tempo necessario per l'asciugatura della colla.
- Con l'ausilio di un rullo o di una spugna, bagnare abbondantemente i fogli di mosaico già posti in opera e attendere qualche minuto.
- Procedere con la rimozione della rete che dovrà essere asportata intera.
- L'eventuale uso di acqua calda o tiepida può ulteriormente facilitare le operazioni di rimozione della rete.
- Con l'ausilio di una spugna o di una spazzola procedere alla pulizia delle tessere per rimuovere eventuali residui di colla.
- Procedere infine con la stuccatura delle fughe.
- The mosaic sheets must be glued as usual, then wait the time necessary for the drying of the glue
- The mosaics sheets already fixed must be generously wet with the help of a roller or a sponge. Then for a few minutes.
- The net can be removed and must be removed entire.
- The eventual use of warm or hot water may further help the removal of the net.
- The mosaic tiles must be cleaned with the help of a sponge or a brush in order to remove any residual glue.
- Carry on with the grouting of the joint.
- Procéder avec l'habituel collage des plaques et attendre le temps nécessaire pour le séchage de la colle.
- À l'aide d'un rouleau ou d'une éponge, mouiller abondamment les plaques de mosaïque mises en place et attendre quelques minutes.
- Procéder avec l'enlèvement de la trame qui doit être retirée entière.
- L'éventuelle utilisation d'eau tiède ou chaude peut faciliter l'enlèvement de la trame davantage
- À l'aide d'une éponge ou d'une brosse, nettoyer les tesselles afin d'élever les éventuelles résidus de colle
- Procéder avec le jointoiment.
- Mit dem normalen Kleben der Mosaikfolie fortfahren und bis zum Trocknen warten.
- Mit Hilfe einer Walze oder eines Schwamms die bereits bearbeiteten Mosaikblätter gründlich bewässern und einige Minuten warten lassen.
- Anschließend das Netz vollständig entfernen.
- Die mögliche Verwendung von warmem oder lauwarmem Wasser kann das Entfernen des Netzes zusätzlich erleichtern.
- Reinigen Sie die Steine mit Hilfe eines Schwamms oder einer Bürste, um allfällige Klebereste zu entfernen.
- Danach verfugen.

Manutenzione e pulizia

Dopo la posa è sempre necessario proteggere i pavimenti e rivestimenti ceramici e bisogna assolutamente evitare di camminare a piedi calzati su ceramiche indicate per esclusivo uso a piedi nudi.

In base alle dimensioni della superficie da trattare la manutenzione potrà poi essere meccanizzata oppure manuale.

La manutenzione delle piastrelle per piscine in gres porcellanato non smaltato **Granitogres** e smaltato **Gresplus** non richiede in genere particolari cure se non le seguenti norme di pulizia.

Prima pulizia

La prima pulizia si esegue normalmente una sola volta dopo la posa delle ceramiche e prima dell'uso del pavimento/ rivestimento in quanto ha lo scopo di eliminare ogni traccia di cemento, colla e/o stucco conseguente alla posa e sigillatura delle fughe.

Una volta asportati i residui e detriti più grossolani presenti sul pavimento si può procedere nel modo seguente:

- 1) Inumidire con acqua la superficie affinché le fughe vengano impregnate e pertanto protette dalla azione corrosiva del detergente a componente acida (decalcificante).
- 2) Stendere il detergente (vedi nota A) nella concentrazione (rapporto di miscelazione con l'acqua) indicata dal produttore applicandolo con una spazzola manuale o motorizzata evitando il contatto con eventuali componenti in acciaio, alluminio e marmo naturale adiacenti al pavimento/ rivestimento.
- 3) Durante il tempo di azione, che deve essere stabilito in relazione allo stato del pavimento, strofinare lo sporco più ostinato e raschiare

eventuali residui di malta, stucco ecc.

- 4) Sciacquare infine il pavimento/ rivestimento con acqua pulita e raccogliere subito l'acqua sporca manualmente o con apparecchio lavasciuga.

Se la prima pulizia viene eseguita dopo che il pavimento/ rivestimento è già stato usato, sarà bene, prima di applicare il detergente a base acida, rimuovere con appositi detergenti alcalini (sgrassanti) eventuali presenze di sostanze grasse o simili (vedi paragrafo "pulizia ordinaria").

L'operazione di prima pulizia, se ritenuto necessario, può essere ripetuta.

A seguito del primo lavaggio acido le ceramiche con finitura superficiale Levigata, Lappata o Lucida possono evidenziare una leggera diminuzione della lucentezza che deve essere considerata normale in quanto dovuta alla eliminazione dei residui degli abrasivi utilizzati nella lavorazione della superficie.

L'impiego di detergenti a base di acido fosforico è da preferire a quelli a base di acido cloridrico in quanto meno aggressivi verso i metalli.

- A) Alcuni detergenti consigliati per eliminare i residui di stucco:

Fughe realizzate con stucco cementizio – detergenti a componente acida (decalcificanti)

Deterprimo Plus (Casalgrande Padana), Deterdek (Fila), Keranet (Mapei), Deltaplus (Kerakoll), Solvacid (Geal) o simili (seguire le istruzioni del produttore del detergente).

Fughe realizzate con stucco epossidico – detergenti a componente alcalina

Fuga-Soap Eco (Kerakoll), Kerapoxy Cleaner (Mapei), Tile Cleaner (Faber), CR10 (Fila), Lithofin Resin- Ex (Lithofin),

Eposolv (Geal) o simili (seguire le istruzioni del produttore del detergente).

Pulizia ordinaria

Per la pulizia di tutti i giorni è sufficiente lavare il pavimento/ rivestimento con acqua e aggiunta di normali prodotti detergenti adatti a pulire superfici ceramiche (per i rivestimenti murali usare detergenti in gel).

Assicurarsi che i detergenti non contengano sostanze cerose; la superficie dei prodotti Casalgrande Padana, essendo praticamente in assorbente, non richiede l'applicazione di cere e/o prodotti siliconici di protezione che, al contrario, non devono mai essere usati in quanto possono creare un film superficiale che andrebbe a modificare le caratteristiche naturali del gres porcellanato.

In presenza di macchie persistenti e difficili da togliere con la pulizia ordinaria, intervenire con l'impiego di detergenti più concentrati lasciando agire gli stessi per un adeguato intervallo di tempo e, successivamente, strofinare con adeguata intensità fino a ricondurre le piastrelle all'aspetto originario.

Al riguardo è opportuno segnalare che il gres è resistente a qualsiasi sostanza chimica, eccezion fatta per l'acido fluoridrico che attacca tutti i prodotti ceramici e che quindi non deve mai essere utilizzato.

Per la pulizia di pavimenti in aree pubbliche si consiglia di intervenire dopo la chiusura dei locali affinché il pavimento possa essere ben asciutto alla riapertura; in alternativa è opportuno isolare il pavimento pulito fino alla sua completa asciugatura.

Per i locali di maggiore estensione è opportuno disporre di macchine lavasciuga al fine di assicurare una perfetta pulizia e igienicità.

Il pavimento deve essere considerato pulito quando riacquista il suo aspetto originario!

Superfici antiscivolo

Per la piastrelle con superficie antiscivolo, impiegate generalmente in ambienti umidi o bagnati, bisogna tenere presente gli specifici problemi di pulizia legati al fatto che le superfici sono in genere ruvide, strutturate oppure a rilievi e impongono quindi una maggiore attenzione.

Per la pulizia di queste superfici si sono affermate come ottimali le macchine lavapavimenti a spazzole controrotanti dove l'alternanza del senso di rotazione permette alle setole di restare sempre perpendicolari al pavimento in modo da raggiungere le eventuali cavità della superficie oppure macchine a rullo.

Non bisogna in nessun caso utilizzare pads abrasivi che potrebbero abrader la superficie delle ceramiche e ridurre conseguentemente i valori antiscivolo originari.

Per le pavimentazioni di più ampie dimensioni si consiglia l'impiego di macchine provviste di dispositivi capaci di aspirare i liquidi, e con essi lo sporco, che viene convogliato e raccolto nell'apposito serbatoio.

Altro mezzo utilizzato per questo tipo di pavimenti è l'idropulitrice avendo però l'accortezza di usare pressioni moderate sulle fughe specie quelle realizzate con fuganti a base cementizia.

Maintenance and cleaning

After the installation it is always necessary to duly cover and protect the floor tiles and avoid to walk with shoes on ceramic tiles in barefoot areas.

Depending on the size of the surface you need to clean, you can choose between a mechanical or manual cleaning method.

The maintenance of Granitogres, unglazed porcelain tiles, and of Gresplus, glazed porcelain tiles, do not require any specific or particular care and the following maintenance instructions are generally enough to reach expected results.

Initial clean

The initial cleaning is normally done only once after tiles installation and before the floor/wall covering is used. The aim of this operation is to eliminate all traces of cement, adhesive and grouting materials after installation.

Once the main residues present on the flooring has been removed, you may proceed in the following way:

- 1) Apply water to the surface so that the joints become wet and therefore are protected from the corrosive properties of acid-based detergent (de-scalers).
- 2) Dilute the detergent (see Note A) with water to the ratio indicated by the manufacturer and apply using a manual or motorised brush. We recommend to avoid contact with any steel, aluminium and natural marble situated near to the floor/wall covering.
- 3) While the detergent lays for a period of time determined according to the conditions of the flooring, scrub the most stubborn dirt away and remove any grout or sealant residue.

- 4) Wash off the floor/wall covering with clean water and immediately get rid of the dirty water either manually or using a floor-cleaning machine.

If the initial cleaning is being carried out after the floor/wall covering has already been used it is necessary to first remove eventual dirt and greasy residuals using alkaline detergents (degreasers) before applying the acid based detergent (see paragraph "ordinary cleaning").

If necessary, the initial cleaning can be repeated more than once.

After the initial cleaning with the acid-based detergent, ceramic tiles with the Levigata, Lappata or Lucida finishes may show a slight reduction in shininess.

This should be considered normal as it is due to the elimination of the remnants of abrasives used to work the surfaces.

Detergents made with phosphoric acid are preferable to those made with hydrochloric acid as they are less damaging to metals.

- A) Detergents suggested for eliminating grouting residue:

Cement-based grouts – acid based detergents (descaling)

Deterprimo Plus (Casalgrande Padana), Deterdek (Fila), Keranet (Mapei), Deltaplus (Kerakoll), Solvacid (Geal) or similar (for the application follow instructions of manufacturer of detergent).

Epoxy-based sealant – alkaline based detergents

Fuga-Soap Eco (Kerakoll), Kerapoxy Cleaner (Mapei), Tile Cleaner (Faber), CR10 (Fila), Lithofin Resin-Ex (Lithofin), Eposolv (Geal) or similar (for the application follow instructions of manufacturer of detergent).

Ordinary cleaning

For everyday cleaning, simply wash the floor/wall covering with water and standard detergents suitable for use on ceramic surfaces (for walls use gel detergents).

Ensure that detergents do not contain waxy substances. Casalgrande Padana products feature virtually non-absorbent surfaces and therefore do not require the application of wax and/or silicon-based protective products. These must never be used because they could create a film on the surface which would alter the original characteristics of the porcelain stoneware.

In the event of persistent stains that are difficult to remove through normal cleaning practices use higher concentrate detergents leaving these to work for an adequate period of time and then rub down with appropriate force until the appearance of the tiles is back to normal.

Please be reminded that porcelain tiles are resistant to all chemical substances except hydrofluoric acid which damages all ceramic products and therefore must never be used.

We suggest that cleaning operations of floors in public buildings are carried out when such places are closed to ensure the floors are fully dry before being used again. Alternatively, cordon off the floor being cleaned until it has dried.

For bigger spaces, the use of a floor-cleaning machine is suggested for perfect cleaning and optimum hygiene.

Floorings should be considered clean when their original appearance has been restored.

Anti-slip surfaces

For slip resistant tiles, which are

generally used for damp or wet areas, it is necessary to consider that such surfaces are generally rough, patterned or feature reliefs and therefore require greater attention and care.

Floor-cleaning machines featuring counter-rotating brushes are excellent for cleaning these surfaces; the alternating direction of rotation means that the bristles stay perpendicular to the floor thus making possible to reach the cavities of the surface. Roller-style cleaning machines are also suitable.

Under no circumstances should abrasive pads be used as these could alter the surface of the tiles thus reducing the original non-slip values.

For larger floors we suggest the use of machines that are able to suck up the cleaning liquids and dirt together collecting them into a designated container.

Pressure washers can also be used for this type of floorings but using moderate pressures thus to avoid damaging the grouting joints, especially if these are the cement-based ones.

Entretien et nettoyage

Après la mise en place, il faut toujours protéger les carrelages et les revêtements céramiques, ainsi qu'éviter de marcher les pieds chaussés sur les céramiques dont l'utilisation est exclusivement les pieds nus.

En fonction des dimensions de la surface à traiter, l'entretien pourra être mécanisé ou manuel.

L'entretien des carreaux pour piscines en grès cérame non émaillé Granitogres et émaillé Gresplus ne demande généralement pas de soins particuliers, en dehors des normes de nettoyage ci-dessous.

Premier nettoyage

Le premier nettoyage ne s'effectue normalement qu'une seule fois après la pose des carreaux et avant l'utilisation du sol/revêtement de façon à éliminer toute trace de ciment, colle et/ou enduit après la pose et le scellement des joints.

Une fois que les plus gros résidus ont été retirés du sol, il est possible de procéder comme suit :

- 1) Mouiller la surface afin que les joints soient imprégnés d'eau et ainsi protégés de l'action corrosive du détergent acide (détartrant).
- 2) Verser le détergent (voir note A) dans la concentration (rapport mélange avec eau) indiquée par le fabricant en l'appliquant avec une brosse manuelle ou motorisée et en évitant tout contact avec d'éventuels composants en acier, aluminium et marbre naturel qui pourraient se trouver près du sol/revêtement.
- 3) Pendant que le produit agit, le temps d'action étant relatif à l'état du sol, frotter la saleté la plus incrustée et gratter les

éventuels résidus de mortier, enduit, etc.

- 4) Enfin, rincer le sol/revêtement à l'eau claire et recueillir immédiatement l'eau sale à la main ou à l'aide d'une auto-laveuse.

Si le premier nettoyage est effectué après que le sol/revêtement a déjà été utilisé, il est conseillé, avant d'appliquer le détergent acide, de retirer avec un détergent alcalin (dégraissant) les éventuelles traces de substances grasses ou semblables (voir paragraphe « nettoyage ordinaire »).

L'opération de premier nettoyage peut être répétée si nécessaire. Suite au premier nettoyage acide, la brillance des dalles en céramique à la finition polie (levigata), rodée (Lappata) ou brillante (Lucida) peut légèrement diminuer, ce qui doit être considéré comme normal étant donné l'élimination des résidus des produits abrasifs utilisés pour le travail de la surface.

Il est préférable d'utiliser des détergents à base d'acide phosphorique plutôt qu'à base d'acide chlorhydrique car ils s'avèrent moins agressifs au contact des différents métaux.

- A) Détergents conseillés pour éliminer les résidus des produits de jointoiement :

Jointes réalisés avec produits à base de ciment - détergents acides (détartrants)

Deterprimo Plus (Casalgrande Padana), Deterdek (Fila), Keranet (Mapei), Deltaplus (Kerakoll), Solvacid (Geal) ou semblables (suivre les instructions du fabricant).

Jointes réalisés avec produits époxy – détergents alcalins

Fuga-Soap Eco (Kerakoll),

Kerapoxy Cleaner (Mapei), Tile Cleaner (Faber), CR10 (Fila), Lithofin Resin- Ex (Lithofin), Eposolv (Geal) ou semblables (suivre les instructions du fabricant).

Nettoyage ordinaire

Pour le nettoyage quotidien, il suffit de laver le sol/revêtement avec de l'eau et un détergent adapté aux surfaces céramiques (utiliser un détergent en gel pour les revêtements muraux).

S'assurer que le détergent ne contient aucune substance cireuse : la surface des produits Casalgrande Padana, n'étant presque pas absorbante, ne requiert pas l'application de cire et/ou de produits de protection à base de silicone.

Ces produits ne doivent, au contraire, jamais être utilisés car ils pourraient créer un film, ce qui modifierait les caractéristiques originelles du grès cérame.

En cas de taches incrustées et difficiles à éliminer avec le nettoyage ordinaire, utiliser un détergent plus concentré et le laisser agir le temps nécessaire et, ensuite, frotter plus ou moins intensément jusqu'à ce que les carreaux retrouvent leur aspect original.

À ce propos, il faut signaler que le grès cérame est résistant à toute substance chimique, à l'exception de l'acide fluorhydrique qui attaque toutes les produits céramiques et qui, par conséquent, ne doit jamais être utilisé.

Pour le nettoyage des sols des zones publiques, il est conseillé d'intervenir après la fermeture des locaux afin que le sol soit bien sec à l'ouverture. Autrement, il est conseillé d'isoler le sol jusqu'à ce qu'il soit complètement sec.

Pour les locaux d'une superficie plus importante, il convient de disposer d'auto-laveuses afin d'assurer un nettoyage parfait ainsi qu'une bonne hygiène.

Le sol doit être considéré comme propre lorsqu'il retrouve son aspect original.

Surfaces antidérapantes

Pour les carreaux antidérapants, utilisés généralement dans les pièces humides, il faut prendre en compte les problèmes spécifiques de nettoyage dus aux surfaces rugueuses, structurées ou en relief : elles demandent une plus grande attention.

Pour nettoyer ces surfaces, les auto-laveuses à brosses contre-rotatives, où la variation du sens de rotation permet aux poils de toujours rester perpendiculaires au sol de façon à atteindre les éventuels creux de la surface, ou les auto-laveuses à rouleau sont particulièrement optimales.

Il ne faut en aucun cas utiliser des tampons abrasifs qui pourraient abraser la surface des carreaux et donc en réduire les propriétés antidérapantes originelles.

Pour les sols de plus grandes dimensions, il est conseillé d'utiliser des machines pourvues de dispositifs pouvant aspirer les liquides et les saletés, qui seront canalisés dans un réceptacle prévu à cet effet.

Le nettoyeur à haute-pression peut également être utilisé pour ce type de sol. Toutefois, il faut que la pression soit modérée sur les joints, et particulièrement ceux réalisés avec des produits à base de ciment.

Pflege und Reinigung

Nach der Verlegung sind Böden und Wände aus Keramik immer zu schützen und es ist unbedingt zu vermeiden, mit Schuhen Keramikflächen zu betreten, die ausschließlich als Barfußbereiche konzipiert sind.

Je nach der Größe der zu behandelnden Oberfläche kann die Instandhaltung mechanisch oder manuell erfolgen.

Die Instandhaltung der Fliesen für Schwimmbäder aus unglasiertem Feinsteinzeug Granitogres und aus glasiertem Feinsteinzeug Gresplus verlangen normalerweise keine besondere Pflege, sondern nur die Befolgung der folgenden Reinigungsvorschriften.

Erstreinigung

Die Erstreinigung erfolgt normalerweise nur einmal nach der Verlegung der Keramikplatten und vor Beginn der Verwendung des Bodenbelags/der Wandverkleidung, da sie vorrangig dazu dient, alle Spuren von Zement, Kleber und/oder Fugenmörtel nach der Verlegung und der Versiegelung der Fugen zu entfernen.

Nachdem Rückstände und größere Verunreinigungen auf dem Bodenbelag entfernt wurden, gehen Sie folgendermaßen vor:

- 1) Die Oberfläche mit Wasser befeuchten, um die Fugen zu imprägnieren und somit vor der ätzenden Wirkung des säurehaltigen Reinigungsmittels (Kalklöser) zu schützen.
- 2) Das Reinigungsprodukt (siehe Anmerkung A) in der vom Hersteller vorgegebenen Konzentration (Mischverhältnis mit Wasser) mit einer Handbürste oder einer motorbetriebenen Bürste auftragen, wobei der Kontakt mit etwaigen angrenzenden Stahl-, Aluminium- und Marmorkomponenten vermieden werden sollte.
- 3) Während der Wirkzeit, die je nach Zustand des

Fußbodens festzulegen ist, den hartnäckigsten Schmutz abreiben und etwaige Mörtel und Kitt Rückstände usw. abkratzen.

- 4) Den Fußboden/die Wandverkleidung schließlich mit sauberem Wasser abspülen und das Schmutzwasser sofort von Hand oder mit einer Bodenreinigungsmaschine aufnehmen.

Wenn die Erstreinigung erst nach der Benutzung des Fußbodens/der Wandverkleidung erfolgt, müssen vor der Anwendung des säurehaltigen Reinigungsmittels etwaige Fette oder ähnliche Stoffe mit geeigneten Alkalireinigern (Fettlösern) entfernt werden (siehe Absatz „Normale Reinigung“).

Falls erforderlich, kann die Erstreinigung wiederholt werden.

Infolge der Erstreinigung von Keramikprodukten mit geschliffener (Levigata), geläppter (Lappata) oder glänzender (Lucida) Oberfläche mit säurehaltigen Mitteln kann ein leichter Glanzverlust auftreten, der als normal betrachtet werden muss, da er auf die Entfernung von Rückständen der für die Oberflächenbearbeitung verwendeten Schleifmittel zurückzuführen ist.

Der Einsatz von Reinigungsmitteln auf Phosphorsäurebasis ist gegenüber solchen auf Salzsäurebasis vorzuziehen, da diese auf Metalle weniger aggressiv wirken.

- A) Einige empfohlene Reinigungsmittel zur Entfernung von Mörtelresten:

Verfugung mit Zementfugenmörtel – säurehaltige Reinigungsmittel (Kalklöser)

Deterprimo Plus (Casalgrande Padana), Deterdek (Fila), Keranet (Mapei), Deltaplus (Kerakoll), Solvacid (Geal) oder ähnliche Mittel (die Angaben des Reinigungsmittelherstellers beachten).

Verfugung mit Epoxidfugenmörtel – alkalische Reinigungsmittel

Fuga-Soap Eco (Kerakoll), Kerapoxy Cleaner (Mapei), Tile Cleaner (Faber), CR10 (Fila), Lithofin Resin-Ex (Lithofin), Eposolv (Geal) oder ähnliche Mittel (die Angaben des Reinigungsmittelherstellers beachten).

Normale Reinigung

Für die Alltagsreinigung genügt es, den Fußboden/die Wandverkleidung mit Wasser und normalen Reinigungsmitteln für Keramikflächen zu reinigen (für Wandverkleidungen Gelreiniger verwenden).

Da die Oberflächen der Produkte von Casalgrande Padana praktisch nicht aufnahmefähig sind, müssen für ihren Schutz keine Wachse und/oder silikonhaltige Produkte aufgetragen werden. Ganz im Gegenteil sollten diese niemals verwendet werden, da sie einen Oberflächenfilm bilden können, der die natürlichen Eigenschaften des Feinsteinzeugs verändert.

Bei beständigen und schwer entfernbaren Flecken, die sich nicht mit einer normalen Reinigung beseitigen lassen, können konzentriertere Reinigungsmittel verwendet werden; diese sollte man für eine angemessene Zeit einwirken lassen und dann angemessen kräftig abreiben, bis die Platten wieder ihr ursprüngliches Aussehen zurückerhalten.

Wir weisen darauf hin, dass Feinsteinzeug gegen alle chemischen Mittel beständig ist, mit Ausnahme von Fluorwasserstoffsäure, die alle Keramikprodukte angreift und daher niemals verwendet werden darf.

In öffentlichen Bereichen sollte die Reinigung nach der Schließzeit vorgenommen werden, damit der Boden bei der Wiedereröffnung trocken ist; anderenfalls sollte der gereinigte Bereich bis zur kompletten

Trocknung abgesperrt werden.

Für große Räumlichkeiten ist der Einsatz von Reinigungsmaschinen empfehlenswert, um eine perfekte Reinigung und Hygiene sicherzustellen. Der Bodenbelag gilt als sauber, wenn er sein ursprüngliches Aussehen wieder angenommen hat.

Rutschfeste Oberflächen

Bei Fliesen mit rutschfester Oberfläche, die in der Regel in feuchten oder nassen Umgebungen verwendet werden, müssen die spezifischen Reinigungsprobleme berücksichtigt werden, die mit der rauen, strukturierten oder reliefierten Oberflächenstruktur zusammenhängen und daher eine besondere Aufmerksamkeit erfordern.

Für die Reinigung dieser Art von Oberflächen haben sich gegenläufig rotierende Bürstmaschinen oder Walzenmaschinen als vorteilhaft erwiesen, bei denen durch den Wechsel der Drehrichtung die Borsten immer senkrecht zum Bodenbelag stehen, um etwaige Oberflächeneinkerbungen erreichen zu können.

Auf keinen Fall sollten Scheuerschwämme verwendet werden, die die Keramikoberfläche abtragen und damit die originale Rutschfestigkeit verringern könnten.

Für größere Bodenflächen empfehlen wir die Verwendung von Maschinen mit Vorrichtungen zum Aufsaugen der Flüssigkeiten und mit diesen des Schmutzes, die dann in einem entsprechenden Behälter gesammelt werden.

Ein weiteres Hilfsmittel zum Reinigen dieser Art von Bodenbelägen ist der Dampfstrahler, allerdings sollte dieser nur mit mäßigem Druck bei Fugen eingesetzt werden, vor allem wenn diese mit Fugenmörtel auf Zementbasis gefertigt wurden.

manutenzione e pulizia / maintenance and cleaning / entretien et nettoyage / pflege und reinigung

TIPO DI SPORCO TYPE OF DIRT TYPE DE SALETE ART DES SCHMUTZES				CATEGORIA DETERGENTE TYPE OF DETERGENT CATEGORIE DETERGENT KATEGORIE DES REINIGUNGSMITTELS	ALCUNI PRODOTTI SUGGERITI SOME RECOMMENDED PRODUCTS QUELQUES PRODUITS SUGGERES EINIGE PRODUKTEMPFEHLUNGEN	
Sangue Oli e grassi animali e vegetali Matita, pennarello e inchiostro Striature di scarpe Caffè, Coca cola e vino rosso Olio motore e pneumatici d'auto	Blood	Sang	Blut	Alcalino Alkaline Alcalin Alkalireiniger	Candeggina	
	Animal and vegetal oils and greases	Huiles et graisses animales et végétales	Tierische und pflanzliche Öle und Fette		Cif	Unilever
	Pencil, felt-tip pens and ink	Crayon, feutre et encre	Bleistift, Filzstift und Tinte		Ajax	Colgate Palmolive
	Scuff marks	Rayures de chaussures	Schuhschlieren		Mastro Lindo	Procter & Gamble
	Coffee, coke and red wine	Café, Coca et vin rouge	Kaffee, Coca Cola und Rotwein		PS 87	Fila
Engine oil and car tyres	Huile moteur et pneus de voiture	Motoröl und Autoreifen		Radiant	Zep	
					Coloured Style Remover	Faber
					Chittone	Madras
					Grundreiniger	Patina Fala
Residui cementizi Residui boiacche colorate Ruggine Depositi calcarei	Cement residues	Résidus de ciment	Zementrückstände	Acido Acidic Acide Reiniger auf Säurebasis	Deterprimo	Casalgrande Padana
	Coloured grout residues	Résidus de mastic coloré	Rückstände von dünnflüssigem Zement		Deterdek	Fila
	Rust	Rouille	Rost		Keranet	Mapei
	Scaling	Dépôts de calcaire	Kalkstein		Deltaplus	Kerakoll
					Terfox	Zep
					Viakal	Procter & Gamble
					Cement Remover	Faber
					Kuku	Lithofin
					Acid-Tech	Patina Fala
					Ras Klinker	Madras
			Nordecalforte	Nord Resine		
Resine Vernici Silicone Nicotina Catrame	Resin	Résines	Harz	Solvente Solvent Solvant Lösungsmittel	Filasolv	Fila
	Paint	Peintures	Lack		F-Ch	Madras
	Silicone	Silicone	Silikon		Solvent Stripper	Faber
	Nicotine	Nicotine	Nikotin		Neutrex	General
	Tar	Goudron	Teer			





© Copyright Casalgrande Padana
Aprile 2021

Casalgrande Padana si riserva di modificare in qualunque momento e senza preavviso le informazioni e le caratteristiche tecniche contenute nel presente catalogo. I colori e l'estetica dei prodotti sono quanto più possibile vicini a quelli reali, nei limiti consentiti dai processi di stampa.

Casalgrande Padana reserves the right, at any moment and without prior notice, to change the information and technical characteristics given in this catalogue. Within the limits of printed material, the colours and aesthetic features of the products illustrated correspond as closely as possible to those of the actual products.

Questo catalogo è stampato su carta certificata FSC®.
This catalog is printed on FSC® certified paper.

Questo catalogo è stampato su carta certificata FSC®.
This catalog is printed on FSC® certified paper.

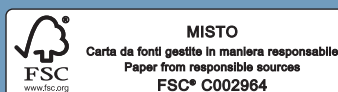



CASALGRANDE
PADANA
Pave your way

Casalgrande Padana s.p.a.
Swimming Pool

Via Statale 467, n°73 - 42013 Casalgrande (RE) - Italia
Tel +39 0522 990801 - Fax +39 0522 771668
pool@casalgrandepadana.it - www.pool.casalgrandepadana.it
info@padanapiscine.com - www.padanapiscine.com

