

Gen era

Catalogo Generale 2024

le

24

Indice per Collezione

Collection index / Index par collection / Inhaltsverzeichnis nach Kollektionen

Marmo e Pietra

STATUARIO.....	37
STATUARIO REALE.....	45
CALACATTA.....	53
CALACATTA ORO.....	61
MACCHIA ANTICA.....	69
BRECCIA ARGENTUM.....	77
BRONZE AMANI.....	85
TRAVERTINO CLASSIC.....	93
AESTHETICA HEGEL.....	101
AESTHETICA WILDE.....	109
ONICE IRIDE.....	117
NAUTILUS.....	125
NOBLE STONE.....	131
BOLGHERI STONE.....	141
GEMSTONE.....	149
COPACABANA EMPEROR.....	159
SAHARA NOIR.....	165
CASTLE.....	171
IMPERIAL.....	177
JUNGLE STONE.....	185
HIGH LINE.....	193
PIERRES DES CHÂTEAUX.....	201
ROYAL STONE.....	209
CHIANCA.....	215
ARDESIA.....	225
STORM.....	233
DOLOMITI.....	241
BLUE EVOLUTION.....	249
IQUARZI.....	255
BORGHİ ITALIANI.....	263

Materico

METAL.....	271
ABSOLUTE.....	279
SKYLINE.....	285
HURBAN.....	293
LE MALTE.....	301
SPACE.....	309
AGGLOMERATE.....	317
ARTILE.....	325
LASCAUX.....	333
COTTODELCASALE.....	339
UP.....	347
SMALL.....	357

Legno

HONEYWOOD.....	369
IL CERRETO.....	387
AMAZON.....	395
CA' FOSCARI.....	403
KAURI.....	411

Design

SCRATCH.....	421
IMAGINE.....	429

Indice Generale

General index / Index général / Allgemeiner Index

INDICE PER FORMATO Index by size Index par taille Index nach Format	4
INDICE PER FORMATO / OUTDOOR Index by size / Outdoor Index par taille / Outdoor Index nach Format / Outdoor	6
INDICE PER DESTINAZIONE D'USO Table of contents broken down according to intended use Index par destination d'usage Index für Verwendungszweck	7
OVERVIEW GRANDI FORMATI Grands formats Grands formats Großformate	8
LA FABBRICA AVA & IL GRUPPO ITALCER	24
LE TAPPE The stages Les étapes Die Etappen	26
ITALCER GROUP IL NOSTRO PRESENTE È SOSTENIBILE Italcerc Group: Our Present is Sustainable Italcerc Group: Notre présent est durable Italcerc Group: Unsere Gegenwart ist nachhaltig	28
IL GRUPPO ITALCER IN VETTA AL SUSTAINABILITY AWARD 2022 Italcerc Group at the top of Sustainability Award 2022 ratings Italcerc Group en tête du Sustainability Award 2022 Italcerc Group an der Spitze bei der Verleihung des Nachhaltigkeitspreises 2022	30
IL GRUPPO ITALCER AL PREMIO CODACONS 2022 Italcerc Group at the Premio Codacons 2022 Italcerc Group au Prix Codacons 2022 Italcerc Group beim Codacons-Preis 2022	31
ITALCER S.p.A. OGGI È SOCIETÀ BENEFIT Italcerc S.p.A. is now a Benefit Company Italcerc S.p.A. est maintenant une Société Benefit Italcerc S.p.A. ist heute eine Società Benefit	32
MARMO E PIETRA	35
MATERICO	269
LEGNO	367
DESIGN	419
PARTE TECNICA Technical Section Partie Technique Technischer Teil	455

Indice per Formato

Index by size / Index par taille / Index nach Format

6 mm

	160x320 63"x126"	160x160 63"x63"	80x160 31½"x63"	80x80 31½"x31½"	120x280 48"x110"	120x240 48"x96"	40x240 16"x96"	24x240 9 ½"x96"	120x120 48"x48"	60x120 24"x48"	Pag.
ABSOLUTE	✓	✓	✓	✓	✓	-	-	-	✓	-	279
AESTHETICA HEGEL	✓	-	-	-	✓	-	-	-	✓	-	101
AESTETICA WILDE	✓	-	-	-	✓	-	-	-	✓	-	109
BOLGHERI STONE	-	-	-	-	✓	-	-	-	-	-	141
BRECCIA ARGENTUM	✓	-	-	-	✓	-	-	-	✓	-	77
BRONZE AMANI	-	-	-	-	✓	-	-	-	-	-	85
CALACATTA	✓	-	-	-	✓	-	-	-	✓	-	53
CALACATTA ORO	✓	-	-	-	✓	-	-	-	✓	-	61
COPACABANA EMPEROR	✓	-	-	-	-	✓	-	-	✓	-	159
GEMSTONE	-	-	-	-	✓	-	-	-	-	-	149
HONEY WOOD	-	-	-	-	-	-	✓	✓	-	-	369
HURBAN	-	-	-	-	✓	-	-	-	✓	-	293
IMAGINE	-	-	-	-	✓	-	-	-	-	-	429
LE MALTE	-	-	-	-	✓	-	-	-	✓	✓	301
MACCHIA ANTICA	✓	-	-	-	✓	-	-	-	✓	-	69
METAL	✓	-	-	-	✓	-	-	-	-	-	271
NAUTILUS	✓	-	-	-	✓	-	-	-	✓	-	125
NOBLE STONE	-	-	-	-	✓	-	-	-	✓	-	131
ONICE IRIDE	✓	-	✓	-	✓	-	-	-	✓	-	117
SAHARA NOIR	-	-	-	-	✓	-	-	-	-	-	165
SCRATCH	✓	✓	✓	✓	✓	-	-	-	-	-	421
SKYLINE	✓	✓	✓	✓	✓	-	-	-	✓	-	285
STATUARIO	✓	-	-	-	✓	-	-	-	✓	-	37
STATUARIO REALE	✓	-	-	-	✓	-	-	-	✓	-	45
TRAVERTINO CLASSIC	✓	-	-	-	✓	-	-	-	-	-	93

8,8 mm

	60,9x60,9 24"x 24"	40,6x60,9 16"x 24"	40,6x40,6 16"x 16"	20,3x40,6 8"x 16"	20,3x20,3 8"x 8"	23,4x148 9"x 58 ½"	30x120 12"x48"	20x120 8"x48"	7,5x40,7 3"x16"	7,5x45 3"x18"	Pag.
AMAZON	-	-	-	-	-	-	-	✓	✓	✓	395
ARTILE	-	-	-	-	-	-	-	✓	-	-	325
CA' FOSCARI	-	-	-	-	-	-	-	✓	✓	✓	403
CASTLE	-	-	-	-	-	-	-	✓	-	-	171
CHIANCA	✓	✓	✓	✓	✓	-	-	-	-	-	215
COTTO DEL CASALE	✓	✓	✓	✓	✓	-	-	-	-	-	339
HIGH LINE	-	-	-	-	-	-	-	✓	-	-	193
HONEY WOOD	-	-	-	-	-	-	✓	✓	✓	-	369
IL CERRETO	-	-	-	-	-	✓	✓	✓	-	-	387
KAURI	-	-	-	-	-	-	-	✓	✓	✓	411
LASCAUX	-	-	-	-	-	-	✓	✓	-	-	333

8,8 mm

	120x120 48"x48"	60x120 24"x48"	60x60 24"x24"	30x60 12"x24"	30,5x60,5 12"x24"	30x30 12"x12"	10x30 4"x12"	100x100 40"x40"	80x180 31½"x71"	80x80 31½"x31½"	20x20 8"x 8"	Pag.
ABSOLUTE	-	✓	✓	-	-	-	-	-	-	-	-	279
AESTHETICA HEGEL	-	✓	-	-	-	-	-	-	-	-	-	101
AESTETICA WILDE	-	✓	-	-	-	-	-	-	-	-	-	109
AGGLOMERATE	✓	✓	✓	✓	-	-	-	-	-	✓	-	317
ARDESIA	-	✓	✓	✓	✓	-	-	-	-	✓	-	225
ARTILE	-	✓	✓	✓	-	-	-	-	-	-	-	325
BOLGHERI STONE	-	✓	✓	-	-	-	-	-	-	-	-	141
BRECCIA ARGENTUM	-	✓	-	-	-	-	-	-	-	-	-	77
BRONZE AMANI	-	✓	-	-	-	-	-	-	-	-	-	85
CALACATTA	-	✓	✓	-	-	-	-	-	-	-	-	53
CALACATTA ORO	-	✓	-	-	-	-	-	-	-	-	-	61
CASTLE	-	✓	-	-	-	-	-	-	-	-	-	171
CHIANCA	-	✓	-	-	-	-	-	✓	-	-	-	215
COPACABANA EMPEROR	-	✓	-	-	-	-	-	-	-	-	-	159
DOLOMITI	-	✓	✓	✓	✓	-	-	-	-	-	-	241
GEMSTONE	-	✓	✓	✓	-	-	-	-	-	-	-	149
HIGH LINE	-	✓	✓	✓	-	-	✓	-	-	-	-	193
HURBAN	-	✓	✓	✓	-	-	-	✓	-	-	-	293
I QUARZI	-	-	✓	✓	✓	✓	-	-	-	-	-	255
IMAGINE	-	✓	-	-	-	-	-	-	-	-	-	429
IMPERIAL	✓	✓	✓	✓	-	-	✓	-	-	-	-	177
JUNGLE STONE	✓	✓	✓	✓	-	-	✓	-	-	-	-	185
KAURI	-	✓	-	-	-	-	-	-	-	-	-	411
LASCAUX	-	✓	✓	✓	-	-	-	-	-	-	-	333
LE MALTE	-	-	-	-	-	-	-	-	-	✓	-	301
MACCHIA ANTICA	-	✓	-	-	-	-	-	-	-	-	-	69
METAL	-	✓	-	-	-	-	-	-	-	-	-	271
NOBLE STONE	-	✓	✓	✓	-	-	-	✓	-	-	-	131
ONICE IRIDE	-	✓	-	-	-	-	-	-	-	-	-	117
PIERRES DES CHÂTEAUX	-	✓	✓	✓	-	-	✓	✓	-	-	-	201
ROYAL STONE	-	✓	✓	✓	✓	-	-	✓	-	-	-	209
SAHARA NOIR	-	✓	-	-	-	-	-	-	✓	-	-	165
SCRATCH	-	✓	-	-	-	-	-	-	-	-	-	421
SKYLINE	-	✓	✓	-	-	-	-	✓	-	-	-	285
SPACE	-	✓	✓	✓	-	-	-	-	✓	✓	✓	309
STATUARIO	-	✓	✓	-	-	-	-	-	-	-	-	37
STATUARIO REALE	-	✓	-	-	-	-	-	-	-	-	-	45
STORM	-	✓	✓	✓	-	-	-	-	✓	✓	-	233
TRAVERTINO CLASSIC	-	✓	-	-	-	-	-	-	-	-	-	93

9 mm

	12,4x10,7 5"x4¼"	10x10 4"x4"	5x25 2"x10"	6,5x20 2½"x8"	5,1x16,1 2"x6½"	Jolly 1,2x20 ½"x8"	Pencil bullnose 3x20 1¼"x8"	Pag.
SMALL	✓	✓	✓	✓	✓	✓	✓	357
UP	-	✓	✓	-	-	✓	-	347

Indice per Formato_Outdoor

Index by size_Outdoor
Index par taille_Outdoor
Index nach Format_Outdoor

OUTDOOR 8,8 mm R11C														Pag.
	60x120 24"x48"	60x60 24"x24"	30x60 12"x24"	30,5x60,5 12"x24"	30x30 12"x12"	100x100 40"x40"	80x80 31½"x31½"	60,9x60,9 24"x24"	40,6x60,9 16"x24"	40,6x40,6 16"x16"	20,3x40,6 8"x16"	20,3x20,3 8"x8"	20x120 8"x48"	
ARDESIA	✓	-	-	-	-	-	✓	-	-	-	-	-	-	225
BORGHI ITALIANI	-	-	-	-	-	-	-	-	✓	✓	✓	✓	-	263
CA' FOSCARI	-	-	-	-	-	-	-	-	-	-	-	-	✓	403
CHIANCA	-	-	-	-	-	✓	-	✓	✓	✓	✓	✓	-	215
COTTO DEL CASALE	-	-	-	-	-	-	-	✓	✓	✓	✓	✓	-	339
DOLOMITI	✓	✓	✓	-	-	-	-	-	-	-	-	-	-	241
HIGH LINE	-	-	-	✓	-	-	-	-	-	-	-	-	-	193
HONEY WOOD	-	-	-	-	-	-	-	-	-	-	-	-	✓	369
HURBAN	-	-	-	-	-	✓	-	-	-	-	-	-	-	293
I QUARZI	-	✓	✓	✓	✓	-	-	-	-	-	✓	-	-	255
IL CERRETO	-	-	-	-	-	-	-	-	-	-	-	-	✓	387
NOBLE STONE	✓	-	-	-	-	-	-	-	-	-	-	-	-	131
PIERRES DES CHÂTEAUX	-	-	-	-	-	✓	-	-	-	-	-	-	-	201
SKYLINE	-	-	-	-	-	✓	-	-	-	-	-	-	-	285
SPACE	-	-	-	-	-	-	✓	-	-	-	-	-	-	309
STORM	-	-	-	✓	-	-	-	-	-	-	-	-	-	233

OUTDOOR 20 mm R11C						Pag.
	60x120 24"x48"	40x120 16"x48"	100x100 40"x40"	80x80 31½"x31½"	60x60 24"x24"	
AGGLOMERATE	-	-	-	✓	-	317
AMAZON	-	✓	-	-	-	395
ARDESIA	-	✓	-	✓	-	225
BLUE EVOLUTION	-	-	-	✓	-	249
CA' FOSCARI	-	✓	-	-	-	403
CHIANCA	-	-	✓	-	-	215
DOLOMITI	-	✓	-	-	-	241
HONEY WOOD	-	✓	-	-	-	369
HURBAN	-	-	✓	-	-	293
I QUARZI	-	-	-	-	✓	255
IL CERRETO	-	✓	-	-	-	387
NOBLE STONE	✓	-	-	-	-	131
PIERRES DES CHÂTEAUX	-	-	✓	-	-	201
ROYAL STONE	-	-	✓	-	✓	209
SKYLINE	-	-	✓	-	-	285
SPACE	-	-	-	✓	-	309
STORM	-	-	-	✓	✓	233

Indice per Destinazione d'uso

Table of contents broken down according to intended use
Index par destination d'usage
Index für Verwendungszweck

	Indoor	Outdoor	Outdoor 20 mm
A	ABSOLUTE	279	
	AESTHETICA HEGEL	101	
	AESTHETICA WILDE	109	
	AGGLOMERATE	317	AGGLOMERATE 317
	AMAZON	395	AMAZON 395
	ARDESIA	225	ARDESIA 225
	ARTILE	325	
B			BLUE EVOLUTION 249
	BOLGHERI STONE	141	
	BRECCIA ARGENTUM	77	
	BRONZE AMANI	85	
C	CA' FOSCARI	403	CA' FOSCARI 403
	CALACATTA	53	
	CALACATTA ORO	61	
	CASTLE	171	
	CHIANCA	215	CHIANCA 215
	COPACABANA EMPEROR	159	
	COTTO DEL CASALE	339	COTTO DEL CASALE 339
D	DOLOMITI	241	DOLOMITI 241
G	GEMSTONE	149	
H	HIGH LINE	193	HIGH LINE 193
	HONEY WOOD	369	HONEY WOOD 369
	HURBAN	293	HURBAN 293
I	I QUARZI	255	I QUARZI 255
	IL CERRETO	387	IL CERRETO 387
	IMAGINE	429	
	IMPERIAL	177	
J	JUNGLE	185	
K	KAURI	411	
L	LASCAUX	333	
	LE MALTE	301	
M	MACCHIA ANTICA	69	
	METAL	271	
N	NAUTILUS	125	
	NOBLE STONE	131	NOBLE STONE 131
O	ONICE IRIDE	117	
P	PIERRES DES CHÂTEAUX	201	PIERRES DES CHÂTEAUX 201
R	ROYAL STONE	209	
S	SAHARA NOIR	165	
	SCRATCH	421	
	SKYLINE	285	SKYLINE 285
	SMALL	357	
	SPACE	309	SPACE 309
	STATUARIO	37	
	STATUARIO REALE	45	
	STORM	233	STORM 233
T	TRAVERTINO CLASSIC	93	
U	UP	347	

Overview

Grandi Formati

Grands formats
Grands formats
Großformate

marmo e pietra



160x320
63"x126"



120x280
48"x110"



120x240
48"x96"



pag. 37

STATUARIO

160x320_63"x126"
120x280_48"x110"

pag. 45

STATUARIO REALE

160x320_63"x126"
120x280_48"x110"

pag. 53

CALACATTA

160x320_63"x126"
120x280_48"x110"

pag. 61

CALACATTA ORO

160x320_63"x126"
120x280_48"x110"

pag. 69

MACCHIA ANTICA

160x320_63"x126"
120x280_48"x110"

pag. 77

BRECCIA ARGENTUM

160x320_63"x126"
120x280_48"x110"

pag. 85

BRONZE AMANI

120x280_48"x110"

pag. 93

TRAVERTINO CLASSIC

160x320_63"x126"
120x280_48"x110"

HEGEL

pag. 101

AESTHETICA

160x320_63"x126"
120x280_48"x110"

WILDE

pag. 109



GIADA

MALAGA

AMBRA

AVORIO

ARGENTO

COBALTO

DARK

TAUPE

GREY

WHITE

BEIGE

pag. 117

**ONICE
IRIDE**

120x280_48"x110"

pag. 117

**ONICE
IRIDE**

160x320_63"x126"

120x280_48"x110"

pag. 125

NAUTILUS

160x320_63"x126"

120x280_48"x110"

pag. 131

**NOBLE
STONE**

120x280_48"x110"



BEIGE

NATURAL

WHITE

SAGE

OCEAN

GREY

NATURAL

DESERT

pag. 141

**BOLGHERI
STONE**

120x280_48"x110"

pag. 149

GEMSTONE

120x280_48"x110"

pag. 159

**COPACABANA
EMPEROR**

160x320_63"x126"
120x240_48"x96"

pag. 165

**SAHARA
NOIR**

120x280_48"x110"

Overview

Grandi Formati

Grands formats
Grands formats
Großformate

materico



160x320
63"x126"



120x280
48"x110"

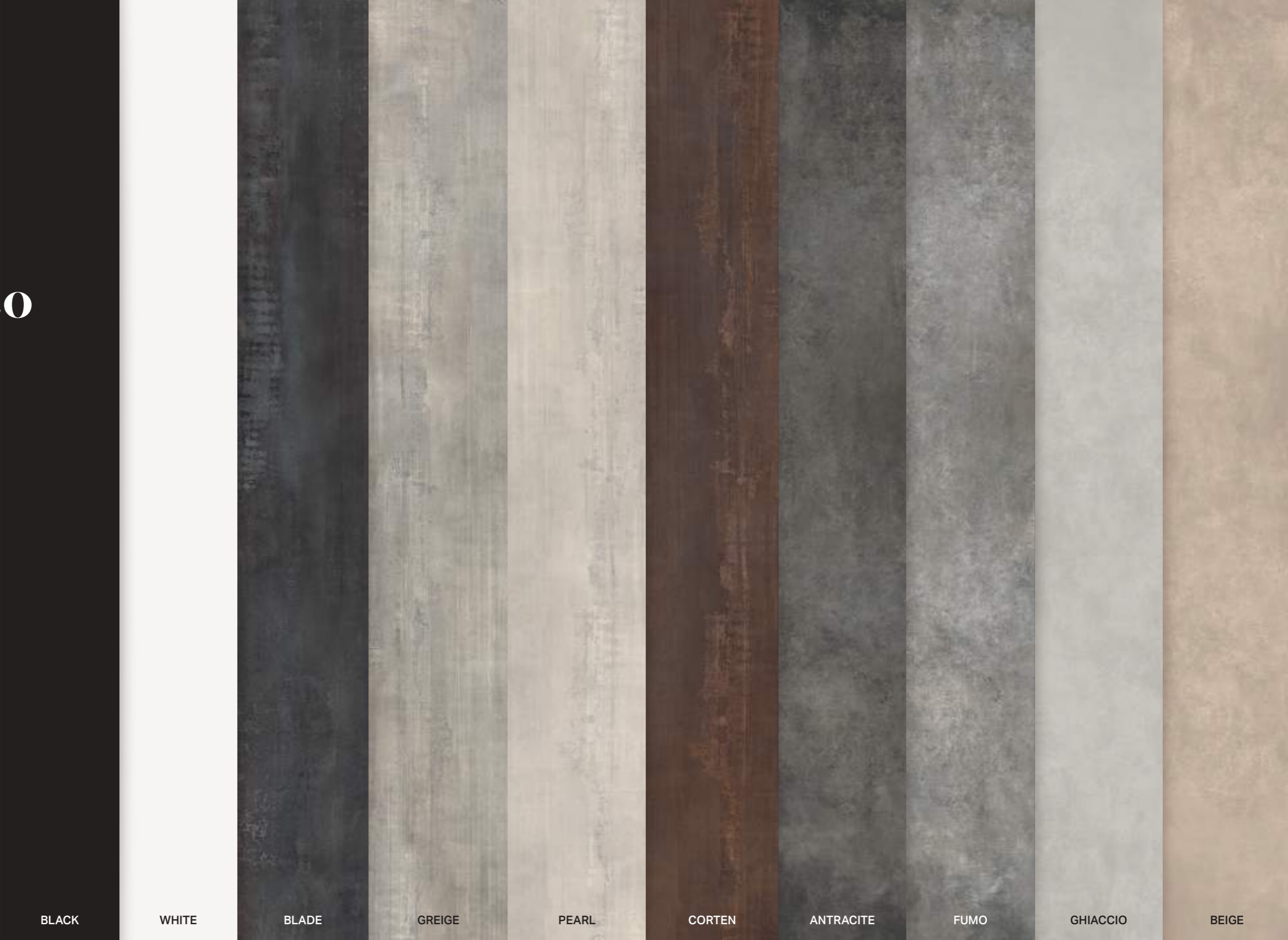

BLACK

WHITE

BLADE

GREIGE

PEARL

CORTEN

ANTRACITE

FUMO

GHIACCIO

BEIGE

pag. 279

ABSOLUTE

160x320_63"x126"
120x280_48"x110"

pag. 271

METAL

160x320_63"x126"
120x280_48"x110"

pag. 285

SKYLINE

160x320_63"x126"
120x280_48"x110"



GRAPHITE

AVIO

WHITE

BEIGE

GRAY

OCRA

GREY

TAUPE

BEIGE

IVORY

SAGE

AVIO

pag. 293

HURBAN

120x280_48"x110"

pag. 301

LE MALTE

120x280_48"x110"

Overview

Grandi Formati

Grands formats
Grands formats
Großformate

legno



NOCE

ROVERE

OLMO

BRICOLA

LARICE



40x240
16"x96"

24x240
9 1/2"x96"

pag. 369

HONEY WOOD

40x240_16"x96"

24x240_9 1/2"x96"

Overview

Grandi Formati

Grands formats
Grands formats
Großformate

design
FUKSAS



160x320
63"x126"



120x280
48"x110"



LIGHT GRAFFITI



DARK GRAFFITI



MOONLIGHT



SUPERLUNA



ECLIPSE



MILKY WAY



pag. 421

SCRATCH

160x320_63"x126"
120x280_48"x110"

Designers: Doriana and Massimiliano Fuskas

Overview

Grandi Formati

Grands formats
Grands formats
Großformate

design



120x280
48"x110"



KENZIA



BOTANICAL



PLUMAGE



NAIF



PARADISE



JUNGLE CHIC



SHADOW LEAVES



AUTUMN



ARECA

pag. 429

IMAGINE

120x280_48"x110"

LA FABBRICA AVA & il Gruppo Italcer



Le tappe

Il Gruppo Italcer

- *Il nostro Presente è Sostenibile:
Il Cammino Ecologico del Gruppo Italcer*
 - *Il Gruppo Italcer in vetta
al Sustainability Award 2022*
 - *Il Gruppo Italcer al Premio Codacons 2022*
-

Italcer S.p.A. oggi è
Società Benefit

The stages

Italcer Group

- *Our present is Sustainable:
The Ecological Path of the Italcer Group*
 - *Italcer Group at the top of Sustainability
Award 2022 ratings*
 - *Italcer Group at the Premio Codacons 2022*
-

Italcer S.p.A. is now
a Benefit Company

Les étapes

Italcer Group

- *Notre présent est durable:
Le parcours écologique du Gruppo Italcer*
 - *Italcer Group en tête du Sustainability
Award 2022*
 - *Italcer Group au Prix Codacons 2022*
-

Italcer S.p.A. est maintenant
une Société Benefit

Die etappen

Italcer Group

- *Unsere Gegenwart ist nachhaltig:
Der ökologische Weg der Italcer-Gruppe*
 - *Italcer Group an der Spitze bei der Verleihung
des Nachhaltigkeitspreises 2022*
 - *Italcer Group beim Codacons-Preis 2022*
-

Italcer S.p.A. ist heute
eine Società Benefit

Le tappe

The stages / Les étapes / Die etappen



Civilization of Beauty

Nasce a Castel Bolognese (RAVENNA) La Fabbrica S.p.A. L'alta qualità legata al design e alla creatività diventano i fattori di riconoscimento e successo attraverso una forza vendita capillare distribuita in Italia e all'estero. Il brand La Fabbrica si conferma in breve tempo come riferimento dell'eccellenza ceramica italiana.

La Fabbrica S.p.A. begins trading in Castel Bolognese (RAVENNA). The high quality linked to design and creativity, soon became factors of recognition and success through a strong sales force scattered throughout Italy and abroad. The Fabbrica brand was quickly confirmed as a reference point for Italian ceramic excellence.

1994



Sempre cavalcando le ultime tendenze del momento al Cersaie 2014 il marchio AVA introduce nel mercato il grande formato. Extraordinary Size è il progetto ambizioso di lastre in gres porcellanato tra le più grandi al mondo, 320x160 in 6 mm, che sviluppa una varietà di collezioni declinate in molteplici grafiche e sottoformati.

Following the last trends, during Cersaie 2014, the AVA brand introduces the big size. Extraordinary Size is the ambitious project of the largest porcelain stoneware slabs in the world, 320x160 cm with a thickness of 6 mm which develops a wide range of collections declined in a great variety of graphics and smaller sizes.

2014



A maggio 2017 La Fabbrica S.p.A. entra a far parte del Gruppo Italcercer, la cui società capogruppo è Italcercer S.p.A., creata dal Fondo Italiano di Private Equity, Mindful Capital Partners (in precedenza Mandarin Capital Partners II), guidata dal CEO Graziano Verdi, col fine di creare un polo di lusso nel settore della ceramica Made in Italy di alta gamma.

In May 2017, La Fabbrica Ceramics became part of Italcercer Group, whose parent company is Italcercer S.p.A., created by the Italian Private Equity Fund, Mindful Capital Partners (previously Mandarin Capital Partners II), headed by CEO Graziano Verdi. The Group's objective is to create a luxury cluster in the high-end ceramic sector.

2017



3 agosto 2017. Acquisizione del 100% di Elios Ceramica S.p.A. con sede a Fiorano Modenese. Elios è il segmento artistico delle piastrelle di ceramica e sottolinea l'attenzione ai dettagli tipici dello stile artigianale.

On August 3rd 2017, 100% acquisition of Elios Ceramica S.p.A. based in Fiorano Modenese. Elios is the artistic ceramic tile segment and highlights the attention to details typical of artisan style.

2017

Devon&Devon

Il 18 ottobre 2017 il Gruppo Italcercer acquisisce la società Devon&Devon S.p.A., leader mondiale nell'arredamento per il bagno di lusso. Devon&Devon esporta in oltre 80 paesi con una rete di negozi, distributori e negozi monomarca situati nelle più importanti capitali europee, USA, Medio Oriente, Cina e Australia.

On October 18th 2017 Italcercer Group acquires Devon&Devon S.p.A., world leader in the luxury bathroom furnishing. Devon&Devon exports to more than 80 countries with a network of boutiques, retailers and flagship stores situated in the most important capital cities of Europe, USA, Middle East, China and Australia.

2017



Il 15 ottobre 2018 il Gruppo Italcercer acquisisce il 100% di Ceramica Rondine, fondata nel 1961 nella zona tra Reggio Emilia e Modena, uno dei più fiorenti gruppi industriali del settore ceramico. Nuovi prodotti, tecnologie innovative, ricerca e sviluppo, qualità, design e rispetto per l'ambiente: sono questi i valori che hanno guidato Rondine attraverso questo primo mezzo secolo di storia.



Nel 2005 Rondine acquisisce l'azienda sassuolese, SprayDry, produttrice di atomizzato, che consente a ceramica Rondine e, successivamente, al Gruppo Italcercer di compiere un importante salto di qualità realizzando in questo modo l'intero ciclo produttivo della piastrella.

On October 15th 2018 Italcercer Group acquires 100% of Ceramica Rondine, founded in 1961 in the area between Reggio Emilia and Modena, one of the most flourishing industrial groups in the ceramic tile sector. New products, innovative technologies, research and development, quality, design and respect for the environment: these are the values that have guided Rondine through this first half century of history. In 2005 Rondine acquired the company SprayDry, situated in Sassuolo (MO), specialized in the production of atomised powder for porcelain stoneware. In this way Ceramica Rondine, and lately Italcercer Group, can guarantee the total product life cycle of the porcelain tile.

2017



ITALCER USA è stata fondata nel dicembre 2018. È stata creata per servire il mercato Americano con delle linee dedicate di prodotto. Agli inizi del 2019 ha inaugurato un prestigioso show-room al Mart di Chicago.

ITALCER USA was founded in December 2018. It was created and strictly dedicated with specific collections to the American market. In early 2019 Italcercer USA Inc. launched its flagship showroom located at the MART in Chicago.

2018



Nell'agosto del 2019 Bottega entra a far parte del Gruppo Italcercer. Si propone come alternativa di alta gamma nella produzione di pavimenti e rivestimenti ceramici in gres porcellanato. La ricerca ed il gusto estetico unito alla cura del particolare fanno dei prodotti Bottega un'eccellenza nel settore della ceramica italiana.

In August 2019 Bottega becomes part of Italcercer Group. It is proposed as a high-end alternative in the production of floors and walls ceramic porcelain stoneware. Research and aesthetic taste combined with attention to detail make Bottega products an excellence in the Italian ceramic sector.

2019



Tonino Lamborghini
LUXURY SURFACES

Nascono la nuova sede e la nuova sala mostra di "La Fabbrica S.p.A." Sempre nel 2020 viene firmato un accordo tra il Gruppo Italcercer e Tonino Lamborghini con il quale La Fabbrica S.p.A. seguirà la produzione e la commercializzazione delle nuove collezioni a marchio Tonino Lamborghini Luxury Surfaces.



Viene anche presentata l'innovativa tecnologia Advance®, una ceramica eco-compatibile in gres porcellanato. Grazie alle sue proprietà antivirali, antibatteriche e fotocatalitiche, Advance® è capace di proteggere maggiormente gli ambienti che ci circondano rendendoli più salubri e riducendo significativamente l'inquinamento.

The new headquarters and the new showroom of "La Fabbrica S.p.A." were opened. An agreement was signed at the end of 2020 between the Italcercer Group and Tonino Lamborghini with which La Fabbrica S.p.A. will follow the production and marketing of the new Tonino Lamborghini Luxury Surfaces collections.

Moreover, we have also presented the innovative Advance® technology, an eco-friendly ceramic in porcelain stoneware. Thanks to its antiviral, antibacterial and photocatalytic properties, Advance® is able to protect the surrounding environment, making them healthier and reducing pollution significantly.

2020

EQUIPE

Equipe Cerámicas SLU entra a far parte del Gruppo Italcercer. Attualmente la società è leader nel settore dei pavimenti e rivestimenti di piccolo formato. La forza di Equipe si basa su prodotti di design di alta qualità, che le consentono di essere un'azienda attuale, innovativa e sempre all'avanguardia.

Equipe Cerámicas SLU became part of Italcercer Group. It's currently the leading company in the sector of small format floor and wall tiles. Equipe additional value is based in a product with an excellent design and high quality, that makes Equipe a company adapted to the new changes and in a progressive pursuit of improvement.

2021

FONDOVALLE

A Ottobre 2022 il Gruppo Italcercer completa il suo portafoglio prodotti, formati che vanno dal 10x10 cm al 160x320 cm, attraverso l'acquisizione di Ceramica Fondovalle, leader mondiale delle grandi lastre con sedi a Marano sul Panaro e Ubersetto.

In October 2022, Italcercer Group has completed its product portfolio, formats ranging from 10x10 cm to 160x320 cm through the acquisition of Ceramica Fondovalle, a world leader in large slabs located in Marano sul Panaro and Ubersetto.

2022



A fine 2023 il Gruppo Italcercer si espande acquisendo Terratinta Group S.r.l. SB, società specializzata nell'alto di gamma delle superfici d'arredo con sede a Fiorano Modenese, confermando la volontà di creare un hub italiano di superfici di design fondato su innovazione, design, attenzione alle persone e all'ambiente.

At the end of 2023, Italcercer Group expands by acquiring Terratinta Group S.r.l. SB, a company specialized in high-end furnishing surfaces based in Fiorano Modenese. This acquisition has confirmed the Group's desire to create a high-end Italian hub of surfaces based on innovation, design, attention to the people who work in it and to the environment.

2023



La Fabbrica S.p.A. viene fusa per incorporazione in Italcercer S.p.A. SB e gli storici marchi vengono unificati in un unico nuovo brand, LA FABBRICA AVA. Una vasta gamma di prodotti in gres porcellanato, dalle grandi lastre al piccolo formato, che uniscono italianità, design innovativo, qualità certificata e performance di altissimo livello.

La Fabbrica S.p.A. is merged by incorporation into Italcercer S.p.A. SB, and its historic brands are unified into a single new brand, LA FABBRICA AVA. A wide range of porcelain stoneware products, from large slabs to small sizes, combining Italian style, design research, certified quality and performance of the highest level.

2023/24

Il nostro Presente è Sostenibile

Il Cammino Ecologico del Gruppo Italcercer

Il Gruppo Italcercer si è affermato per la sua **attenzione alle tematiche di sostenibilità**, soprattutto grazie al costante impegno nella riduzione degli impatti ambientali derivanti dalle proprie attività operative e agli investimenti nella ricerca e nello sviluppo di soluzioni alternative per la produzione di ceramica.

Nel corso degli anni, sono stati effettuati importanti investimenti e progettualità nell'ambito della sostenibilità ambientale, sociale e di prodotto. Per esempio, attraverso **l'installazione di impianti fotovoltaici e di cogenerazione** per la produzione di energia elettrica e per il recupero del calore dal ciclo produttivo, nonché mediante lo sviluppo di un modello di economia circolare che mira a ridurre l'impatto ambientale delle sue operazioni attraverso **la riduzione dei rifiuti e il riutilizzo dei materiali**.

Our Present is Sustainable: The Ecological Path of the Italcercer Group

The Italcercer Group has made a name for itself for its **attention to sustainability issues**, especially through its constant commitment to reducing the environmental impact of its operations and its investments in research and development of alternative solutions for ceramic production.

Over the years, significant investments have been made and projects developed in environmental, social and product sustainability.

For example, through the **installation of photovoltaic and cogeneration plants** to produce electricity and recover heat from the production cycle, as well as through the development of a circular economy model that aims to reduce the environmental impact of its operations by **reducing waste and reusing materials**.

Notre présent est durable: Le parcours écologique du Groupe Italcercer

Le Groupe Italcercer s'est démarqué pour son **attention aux thèmes de la durabilité**, surtout grâce à son engagement constant pour réduire les impacts de ses activités sur l'environnement et à ses investissements dans la recherche et le développement de solutions alternatives pour la production de céramique.

Au fil des années, d'importants investissements et projets ont été réalisés dans le domaine du développement environnemental, social et du produit. Comme par exemple, à travers le déploiement d'**installations photovoltaïques et de cogénération** pour la production d'électricité et pour la récupération de la chaleur produite par le cycle de production, ou encore à travers le développement d'un modèle d'économie circulaire qui vise à réduire l'impact sur l'environnement de ses opérations par le biais de la **réduction des déchets et la réutilisation des matériaux**.

Unsere Gegenwart ist nachhaltig: Der ökologische Weg der Italcercer-Gruppe

Die Italcercer-Gruppe hat sich durch ihre **Konzentration auf Fragen der Nachhaltigkeit**, insbesondere durch ihre ständigen Bemühungen, die Umweltauswirkungen ihrer Tätigkeit zu verringern, und ihre Investitionen in die Forschung und Entwicklung alternativer Lösungen für die Keramikproduktion, einen Namen gemacht.

Im Laufe der Jahre wurden erhebliche Investitionen und Projekte in den Bereichen Umwelt, Soziales und Produktnachhaltigkeit getätigt. Zum Beispiel durch die **Installation von Photovoltaik- und Kraft-Wärme-Kopplungsanlagen** zur Erzeugung von Strom und Rückgewinnung von Wärme aus dem Produktionskreislauf sowie durch die Entwicklung eines Kreislaufwirtschaftsmodells, das darauf abzielt, die Umweltauswirkungen der Tätigkeiten der Gruppe durch **Abfallvermeidung und die Wiederverwendung von Materialien** zu verringern.



50%



99%



100%

È stata inoltre sviluppata una gamma di prodotti innovativi che contengono più del **50% di materie prime riciclate**, come certificato annualmente da Certiquality, organismo di certificazione indipendente partner di IQNET (International Certification Network). Il Gruppo Italcercer è stato in grado di **ridurre** in modo significativo gli **scarti di produzione**, ogni anno avvia ad operazioni di recupero, presso ditte esterne autorizzate, **oltre il 99% degli scarti generati**.

Nell'ambito dell'utilizzo delle risorse idriche, inoltre, il Gruppo Italcercer ha adottato pratiche di gestione sostenibile della risorsa acqua nel processo di produzione delle ceramiche, le quali consentono di riutilizzare, **recuperare e riciclare il 100% dell'acqua**.

A range of innovative products has also been developed that contain more than **50% recycled raw materials**, as certified annually by Certiquality, an independent certification body and partner of IQNET (International Certification Network).

The Italcercer Group has been able to significantly reduce production waste; each year it sends **over 99% of generated waste** to authorised external companies for recovery.

With regard to the use of water resources, moreover, the Italcercer Group has adopted sustainable water management practices in the ceramics production process, which allow **100% of water** to be reused, recovered and recirculated.

De plus, une gamme de produits innovants a été développée contenant plus de **50% de matières premières recyclées**, un aspect certifié tous les ans par Certiquality, un organisme de certification indépendant partenaire d'IQNET (International Certification Network).

Le Groupe Italcercer a été en mesure de réduire, de façon importante, les déchets de production. En effet, tous les ans, il récupère **plus de 99% des déchets produits** auprès d'entreprises externes autorisées.

Dans le cadre de l'utilisation des ressources hydriques, le Groupe Italcercer a également adopté des pratiques de gestion durable de l'eau dans le cadre du processus de production des céramiques qui permettent de **réutiliser, de récupérer et de recycler 100% de l'eau**.

Zudem wurde auch eine Reihe innovativer Produkte die mehr als **50% recycelter Rohstoffe** enthalten, entwickelt, die jedes Jahr von Certiquality, einer unabhängigen Zertifizierungsstelle und Partner von IQNET (International Certification Network), zertifiziert werden. Die Italcercer-Gruppe war in der Lage, die Menge an Produktionsabfällen deutlich zu reduzieren, jährlich werden **über 99% der erzeugten Abfälle** bei externen autorisierten Firmen recycelt.

Im Bereich der Nutzung der Wasserressourcen hat die Italcercer-Gruppe außerdem Praktiken für die nachhaltige Bewirtschaftung der Ressource Wasser in der Keramikproduktion eingeführt, die die Wiederverwendung, Rückgewinnung und Rückführung von **100% des Wassers** erlauben.



**ITALCER - WINNER OF THE
2022 SUSTAINABILITY AWARD**

Il Gruppo Italcera in vetta al Sustainability Award 2022

Nel 2022, **Italcera è stata riconosciuta al vertice** della classifica, stilata dal Team Credit Suisse, Kon Group e Forbes, **tra le 100 eccellenze italiane premiate al Sustainability Award 2022.**

Il riconoscimento è riservato alle aziende italiane che si sono contraddistinte maggiormente nell'affrontare le sfide odierne, quali l'emergenza climatica, le mutate esigenze dei dipendenti ed in generale le richieste dei molteplici stakeholder, trasformandole in un'occasione per esprimere **innovazione, lungimiranza e proattività di crescita.** Le aziende partecipanti sono state selezionate e valutate dagli organizzatori attraverso criteri in cui si teneva conto del rating ESG dell'azienda, emesso da Altis Università Cattolica e da Reprisk, a cui è stato attribuito il punteggio da parte di Altis, ed il controllo incrociato dei risultati attraverso gli indicatori di Reprisk. Ciò ha consentito agli organizzatori di selezionare le imprese che maggiormente si sono distinte e operano da anni per una produzione sostenibile.

Italcera Group at the top of Sustainability Award 2022 ratings

In 2022, Italcera was recognised as one of the top 100 Italian companies to receive the Sustainability Award 2022, in the ratings drawn up by Credit Suisse, Kon Group and Forbes. The award is reserved for Italian companies that have distinguished themselves most in facing today's challenges, such as the climate emergency, the changing needs of employees and in general the demands of multiple stakeholders, transforming them into an opportunity to express innovation, far-sightedness and proactive growth. The participating companies were selected and assessed by the organisers through criteria that took into account the company's ESG rating, issued by Altis Università Cattolica and Reprisk, and the cross-checked results through Reprisk's indicators. This allowed the organisers to select the companies that stood out the most and which have been working for years on sustainable production.



Italcera Group en tête du Sustainability Award 2022

En 2022, Italcera est arrivé en tête du classement, dressé par le Team Credit Suisse, Kon Group et Forbes, des 100 excellences italiennes primées au Sustainability Award 2022. La reconnaissance est réservée aux entreprises italiennes qui ont su relever les défis actuels, comme la crise climatique, les nouvelles modalités de travail des employés-e-s et, en général, les demandes des multiples parties prenantes, en les transformant en une occasion d'exprimer de l'innovation, de la clairvoyance et de la proactivité pour se développer. Les entreprises participantes ont été sélectionnées et évaluées par les organisateurs en appliquant des critères qui tiennent compte de la note ESG de l'entreprise, attribuée par l'Altis Università Cattolica et par Reprisk, à laquelle Altis a attribué le score et le contrôle croisé des résultats à travers les indicateurs de Reprisk. Les organisateurs ont ainsi pu sélectionner les entreprises qui se sont démarquées le plus et qui agissent depuis des années pour une production durable.

Italcera Group an der Spitze bei der Verleihung des Nachhaltigkeitspreises 2022

Im Jahre 2022 wurde Italcera im Rahmen des von Credit Suisse, Kon Group und Forbes aufgesetzten Sustainability Award 2022 als eines der 100 Spitzenunternehmen Italiens ausgezeichnet. Diese Auszeichnung ist den italienischen Unternehmen vorbehalten, die sich am meisten durch die Bewältigung der heutigen Herausforderungen, wie z. B. des Klimanotstands, der sich ändernden Bedürfnisse der Arbeitnehmer und allgemein der Anforderungen zahlreicher Stakeholders, hervorgetan haben und diese in eine Chance für Innovation, Weitblick und proaktives Wachstum verwandelt haben. Die teilnehmenden Unternehmen wurden von den Organisatoren anhand von Kriterien ausgewählt und bewertet, die das ESG-Rating des Unternehmens, das von der Altis Università Cattolica und von Reprisk abgegeben wurde, sowie die Gegenprüfung der Ergebnisse anhand von Reprisk-Indikatoren berücksichtigten. So konnten die Organisatoren die Unternehmen auswählen, die sich am meisten hervorgetan haben und seit Jahren an einer nachhaltigen Produktion arbeiten.

Il Gruppo Italcera al Premio Codacons 2022

Il 5 luglio 2022 Italcera ha annunciato di aver preso parte al **Premio Codacons "Amico Del Consumatore 2022"**. Trattasi di un riconoscimento che ogni anno il Codacons assegna ad aziende, enti e soggetti i quali si sono distinti per attività a favore dei cittadini e a tutela della collettività, e che hanno **adottato misure tese a ridurre le emissioni di CO₂**. L'assegnazione del premio valorizza l'operato di Italcera, facendo in modo che sia riconosciuta tra le 55 migliori aziende che si impegnano nella lotta al cambiamento climatico attraverso la diminuzione delle emissioni di Greenhouse Gases.

Italcera Group at the Premio Codacons 2022

On 5 July 2022, Italcera announced that it had taken part in the Codacons "Amico del Consumatore (Friend of the Consumer) 2022" award. This is an award that Codacons assigns each year to companies, entities and individuals that have distinguished themselves for activities in favour of the public and for the protection of the community and that have adopted measures to reduce CO₂ emissions. The award enhances Italcera's work, ensuring that the company is recognised as one of the 55 most committed to fighting climate change through the reduction of Greenhouse Gas emissions.

Italcera Group au Prix Codacons 2022

Le 5 juillet 2022, Italcera a annoncé avoir participé au Prix Codacons « Amico Del Consumatore 2022 » [n.d.t.: L'ami du consommateur 2022]. Il s'agit d'une reconnaissance que, chaque année, le Codacons remet aux entreprises, aux organismes et aux personnes qui se sont distingués pour leurs activités en faveur des citoyens-ne-s et de la protection de la collectivité et qui ont adopté des mesures visant à réduire les émissions de CO₂. Ce prix récompense le travail d'Italcera, en la classant parmi les 55 meilleures entreprises engagées dans la lutte au changement climatique à travers la réduction des émissions des gaz à effet de serre.

Italcera Group beim Codacons-Preis 2022

Am 5. Juli 2022 gab Italcera bekannt, am Codacons-Preis "Amico del Consumatore/Verbraucherfreund 2022" teilgenommen zu haben. Diese Auszeichnung vergibt Codacons jedes Jahr an Unternehmen, Organisationen und Einzelpersonen, die sich durch ihre Aktivitäten zugunsten der Bürger und der Gemeinschaft hervorgetan und Maßnahmen zur Reduzierung der CO₂-Emissionen ergriffen haben. Die Vergabe wertet die Arbeit von Italcera auf und stellt sicher, dass das Unternehmen als eines der 55 besten Unternehmen anerkannt wird, die sich für die Bekämpfung des Klimawandels durch die Reduzierung von Treibhausgasemissionen einsetzen.

Italcer S.p.A. oggi è Società Benefit

Nel 2023 Italcer S.p.A. ha assunto la qualifica di Società Benefit diventando Italcer Società per Azioni Società Benefit.

Tale trasformazione implica un'assunzione ulteriore di responsabilità del Consiglio di Amministrazione e della dirigenza verso persone, comunità, territori e ambiente nel quale la società opera, e ha richiesto l'inserimento nel proprio statuto sociale, ad integrazione dei consueti obiettivi di profitto, degli obiettivi di beneficio comune elencati di seguito:

- La riduzione delle emissioni di gas climalteranti nei processi aziendali;
- Lo sviluppo di politiche aziendali di cattura delle emissioni aziendali di gas effetto-serra;
- L'incremento dell'impiego di energia da fonti rinnovabili anche attraverso l'autoproduzione di energia da fotovoltaico;
- La riduzione dei consumi attraverso interventi di efficientamento energetico, ad esempio attraverso l'autoproduzione di energia elettrica con cogenerazione ad alto rendimento e recupero di calore nel ciclo produttivo;
- La costante innovazione di prodotto in grado di proporre politiche aziendali di economia circolare e di ottimizzazione dei consumi energetici e delle risorse a beneficio del territorio di riferimento;
- L'attuazione di politiche di welfare aziendale e territoriale a beneficio dei propri dipendenti;
- Lo sviluppo di percorsi di costante attenzione ai processi produttivi industriali, con un focus particolare sulla sicurezza sul lavoro;
- L'identificazione dell'impresa come soggetto di riferimento aggregativo sul territorio per i portatori di interesse delle comunità locali di riferimento;
- La promozione della cultura della diversità e della inclusione internamente alla Società e sul territorio ove opera.

Italcer S.p.A. is now a Benefit Company

In 2023 Italcer S.p.A. reached the status of Benefit Company, becoming Italcer Società per Azioni Società Benefit.

This transformation implies a further assumption of responsibility by both the Board of Directors and the management towards people, communities, territories and the environment in which the company operates, and has required the inclusion in its corporate bylaws, in addition to the usual profit-oriented objectives, of the following common benefit objectives:

- *The constant reduction of greenhouse gas emissions in company processes;*
- *The development of company policies for capturing CO₂ emissions of greenhouse gases;*
- *The increase in the use of energy from renewable sources, also through the self-production of photovoltaic energy;*
- *The reduction of consumption through energy efficiency measures, for example through the self-production of electricity with high-efficiency cogeneration and heat recovery in the production cycle;*
- *The constant product innovation, to enhance circular economy and optimize of energy consumption and resources for the benefit of the area where the production sites are located;*
- *The propose and implement corporate and territorial welfare policies for the benefit of the employees;*
- *The increase of attention to industrial production processes with a particular focus on job safety;*
- *The company identification as an aggregative point of reference in the area for the stakeholders of the local communities;*
- *The promotion of the culture of Diversity and Inclusion within the company and in the area where it operates.*

Italcer S.p.A. est maintenant une Société Benefit

Dans le 2023 Italcer S.p.A. a atteint le statut de Société Benefit, devenant Italcer Società per Azioni Società Benefit.

Cette évolution implique une nouvelle prise de responsabilité de la part du Conseil d'Administration et de la direction envers les personnes, les communautés, les territoires et l'environnement dans lequel l'entreprise opère et a nécessité l'inclusion dans son statut social, en plus des objectifs habituels de profit, des objectifs communs come indiqués ci-dessous:

- *La réduction des émissions de gaz à effet de serre dans les processus des entreprises;*
- *L'élaboration de politiques d'entreprise pour capter les émissions de gaz à effet de serre des entreprises;*
- *L'augmentation de l'utilisation d'énergies issues de sources renouvelables également à travers l'autoproduction d'énergie photovoltaïque;*
- *La réduction de la consommation grâce à des mesures d'efficacité énergétique, par exemple à travers l'autoproduction d'électricité avec cogénération à haut rendement et récupération de chaleur dans le cycle de production;*
- *Une innovation des produits constate capable de proposer des politiques d'entreprise d'économie circulaire et d'optimisation de la consommation d'énergie et des ressources au profit du territoire de référence;*
- *La mise en œuvre de politiques sociales d'entreprise et locales au bénéfice de ses salariés;*
- *Le développement d'un regard attentif envers les processus de production industrielle avec un aperçu particulier à la sécurité au travail;*
- *L'identification de l'entreprise comme entité agrégative de référence sur le territoire pour les acteurs des communautés locales de référence;*
- *La promotion de la culture de la diversité et de l'inclusion au sein de l'entreprise et dans le territoire où elle opère.*

Italcer S.p.A. ist heute eine Società Benefit

Italcer S.p.A hat im Jahr 2023 den Status einer „Società Benefit“ erlangt hat und in Italcer Società per Azioni Società Benefit qualifiziert wurde.

Diese Umwandlung impliziert eine weitere Übernahme von Verantwortungen sowohl durch den Vorstand als auch durch das Management gegenüber Menschen, Gemeinschaften, Gebiete und der Umgebung, in der das Unternehmen tätig ist. Zur Ergänzung der Gewinnziele des Unternehmens, haben wir zu unseren rechtlichen Grundlagen folgende gemeinsame Benefizziele integriert:

- *Die ständige Reduzierung der Treibhausgasemissionen in Unternehmensprozessen;*
- *Die Entwicklung von Unternehmensrichtlinien zur Erfassung der CO₂-Emissionen von Treibhausgasen;*
- *Der Zuwachs der Nutzung von Energie aus erneuerbaren Quellen, auch durch die Eigenproduktion von Photovoltaik-Energie;*
- *Die Reduzierung des Verbrauchs durch Energieeffizienzmaßnahmen, beispielsweise durch die Eigenproduktion von Strom mit hocheffizienter Kraft-Wärme-Kopplung und Wärmerückgewinnung im Produktionskreislauf;*
- *Die ständige Produktinnovation, um die Kreislaufwirtschaft zu fördern, den Energieverbrauch und die Ressourcen zum Nutzen der Region, in der sich die Produktionsstandorte befinden, zu optimieren;*
- *Umsetzung der betrieblichen Welfare-Leistungen und Gebietswohlfahrtspolitik zum Wohle der Mitarbeiter;*
- *Die verstärkte Aufmerksamkeit für industrielle Produktionsprozesse mit besonderem Schwerpunkt auf Arbeitssicherheit.*
- *Das Unternehmen identifiziert sich als Bezugspunkt aller Anspruchsgruppen im Gebiet, und*
- *Fördert die Inklusion innerhalb des Unternehmens der Kultur Vielfalt im Gebiet selber, in dem es tätig ist.*

marmo e pietra

Statuario	37
Statuario Reale	45
Calacatta	53
Calacatta Oro	61
Macchia Antica	69
Breccia Argentum	77
Bronze Amani	85
Travertino Classic	93
Aesthetica Hegel	101
Aesthetica Wilde	109
Onice Iride	117
Nautilus	125
Noble Stone	131
Bolgheri Stone	141
Gemstone	149
Copacabana Emperor	159
Sahara Noir	165
Castle	171
Imperial	177
Jungle Stone	185
High Line	193
Pierres des Châteaux	201
Royal Stone	209
Chianca	215
Ardesia	225
Storm	233
Dolomiti	241
Blue Evolution	249
I Quarzi	255
Borghi Italiani	263



Statuario

Statuario
MARMO E PIETRA

6 mm



160x320
63"x126"
Nat Ret
Lap Ret



120x280
48"x110"
Nat Ret
Lap Ret



120x120
48"x48"
Nat Ret
Lap Ret

Decoro / Decor



Mosaico 30x30
12"x12"
Nat Ret
Lap Ret



Slab A
160x320
63"x126"
Lap Ret



Slab B
160x320
63"x126"
Lap Ret

8,8 mm



60x120
24"x48"
Nat Ret
Lap Ret



60x60
24"x24"
Nat Ret
Lap Ret

— modular system —

Sviluppo grafico per formato
Pattern by size
Développement graphique par format
Grafischer Entwurf für Format



160x320
6 mm

7

160x320
6 mm

2
Slab A/B

120x280
6 mm

11

120x120
6 mm

22

60x120
8,8 mm

30

60x60
8,8 mm

30

Sviluppo Grafico

Pattern by size. Développement graphique par format.
Grafischer Entwurf für Format.

160x320 6 mm



7 patterns

Macchia Aperta

Book match. Taches ouvertes. Offen Flecken.



Statuario

6 mm

	160x320 63"x126"		120x280 48"x110"		120x120 48"x48"		Mosaico 30x30 12"x12"	
	Nat Ret	Lap Ret	Nat Ret	Lap Ret	Nat Ret	Lap Ret	Nat Ret	Lap Ret
	083004	083003	083017	083027	083034	083033	083194	083193
Price code	M173	M197	M153	M175	M141	M169	M193	M235

6 mm

	160x320 63"x126"	
	Lap Ret	
	083091 A	083092 B
Price code	M197	

8,8 mm

	60x120 24"x48"		60x60 24"x24"	
	Nat Ret	Lap Ret	Nat Ret	Lap Ret
	083064	083063	083084	083083
Price code	M109	M125	M089	M113

Pezzi Speciali / Trims. Pièces speciale. Die Sonderstücke

6 mm

	33x120		33x120	
	Nat Ret	Lap Ret	Nat Ret	Lap Ret
	083262	083263	083342 SX 083302 DX	083343 SX 083303 DX
Price code	P243	P265	P273	P283

8,8 mm

	6,5x120		33x120		33x120	
	Nat Ret	Lap Ret	Nat Ret	Lap Ret	Nat Ret	Lap Ret
	083214	083213	083284	083283	083362 SX 083322 DX	083363 SX 083323 DX
Price code	P040	P043	P207	P215	P231	P243



Backsplash / Counter top / Furniture
Statuario Lap

Imballi / Packings. Emballage. Verpackung

	PCS/BOX	MQ/BOX	KG/BOX	PCS/PAL	BOX/PAL	MQ/PAL	KG/PAL	PACKING	PACKING SIZE	TARE (KG)
6 mm										
160 x 320 + SLAB A/B	-	-	-	14	-	71,68	1.178	CASSA	345 x 175 x 37h	140
120 x 280	-	-	-	20	-	67,20	1.081	CASSA	292 x 145 x 35h	108
120 x 120	2	2,88	41,70	-	24	69,12	1.041	PALLET SPECIALE	123 x 143 x 74h	29
MOSAICO 30x30	9	0,81	11,90	-	60	48,60	716	EPAL	80 x 120	22
8,8 mm										
60 x 120 Nat	2	1,44	27,9	-	32	46,08	895	EPAL	80 x 120	22
60 x 120 Lap	2	1,44	27,9	-	30	43,20	839	EPAL	80 x 120	22
60 x 60	3	1,08	21	-	40	43,20	842	EPAL	80 x 120	22



Cavalletto in legno
Wood A-Frame. Support en bois.
Holzgestell



Cassa
Crate. Caisse. Kiste



Pallet speciale con sponde
Special pallet with sides.
Palette spéciale avec bords.
Spezial-Palette mit Wandungen.



Epal/Pallet

Pezzi Speciali / Trims	PCS/BOX	MQ/BOX	KG/BOX	PACKING	PACKING SIZE
6 mm					
GRADINO COSTA RETTA 33 x 120 x 3,2h	2	-	14	PALLET	80 x 120
GRADINO COSTA RETTA 33 x 120 x 3,2h SX/DX	1	-	7	PALLET	80 x 120
8,8 mm					
BATTISCOPA 6,5x120	6	-	11,40	PALLET	80 x 120
GRADINO COSTA RETTA 33 x 120 x 3,2h	2	-	22	PALLET	80 x 120
GRADINO COSTA RETTA 33 x 120 x 3,2h SX/DX	1	-	11	PALLET	80 x 120

** A disposizione solo su richiesta. Tempi di consegna: 30gg
Available upon request only. Delivery terms: 30 days
Disponible seulement sur requête. Délais de livraison: 30 jours
Verfügbar auf Anfrage. Lieferzeit: 30 Tage

Statuario Reale

Statuario Reale

MARMO E PIETRA

V2
SHADE SPECTRUM
MODERATE

ISO 13006 - G - Bla_E ≤ 0,5% - UNI EN 14411 - UGL
ANSI A - 326.3: 2021
WET DYNAMIC COEFFICIENT OF FRICTION

DCOF ≥ 0,42
naturale

100 % DESIGN AND
PRODUCTION OF ITALY

Statuario Reale
MARMO E PIETRA

6 mm



160x320
63"x126"
Nat Ret
Lap Ret



120x280
48"x110"
Nat Ret
Lap Ret



120x120
48"x48"
Lap Ret

8,8 mm R10A naturale



60x120
24"x48"
Nat Ret
Lap Ret

Sviluppo grafico per formato
Pattern by size
Développement graphique par format
Grafischer Entwurf für Format



160x320
6 mm

6

120x280
6 mm

6

120x120
6 mm

12

60x120
8,8 mm

30

Sviluppo Grafico

Pattern by size. Développement graphique par format. Grafischer Entwurf für Format

160x320 6 mm



6 patterns

Composizione a vena continua

Continuous vein effect. Composition à nervures continues. Durchgehender marmorierung

COMPOSIZIONE DI 6 LASTRE A VENA CONTINUA FORMATO 160x320 SP 6 MM _63"x126" THK 6 MM
DISPONIBILE CON FINITURA NATURALE RETTIFICATA OPPURE LAPPATA RETTIFICATA

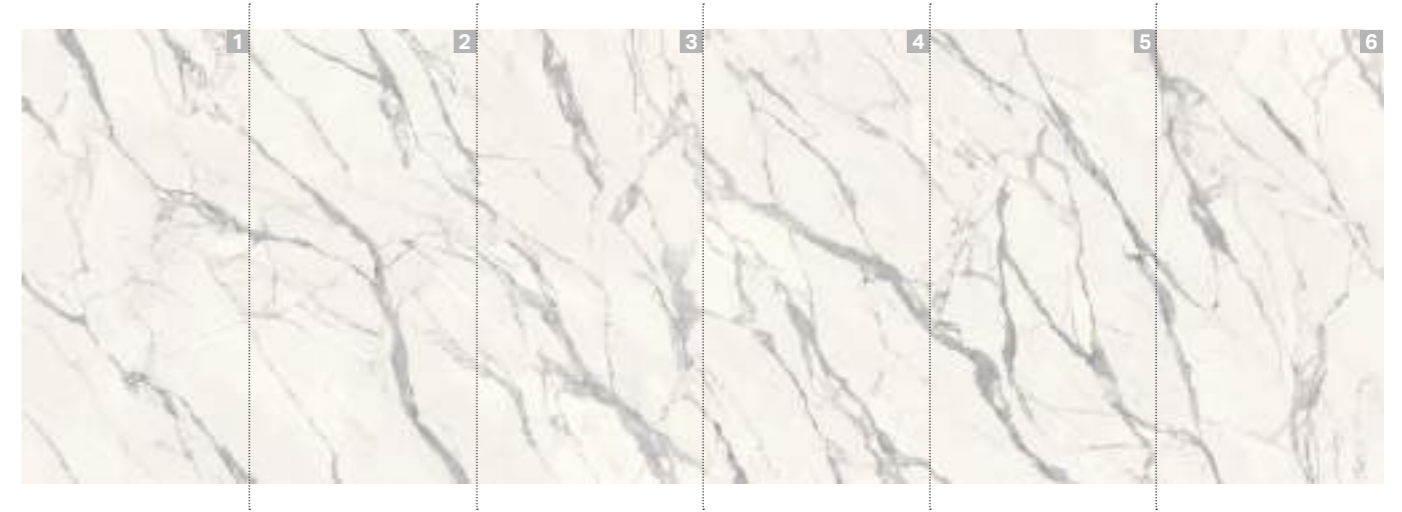

Composition with 6 continuous vein tiles size 160x320 thk 6 mm _63"x126" thk 6 mm available with natural rectified or lapped rectified finish.
Composition de 6 plaques à veines continues format 160x320 ép. 6 Mm disponible avec finition naturelle rectifiée ou rodée rectifiée.
Zusammenstellung aus 6 st. Platten mit durchgehender marmorierung, format 160x320, st. 6 Mm _126"x63" thk 6 mm verfügbar mit finish natur geschliffen oder geläpft geschliffen.

COMPOSIZIONE DI 6 LASTRE A VENA CONTINUA FORMATO 120x280 SP 6 MM _48"x110" THK 6 MM
DISPONIBILE CON FINITURA NATURALE RETTIFICATA OPPURE LAPPATA RETTIFICATA

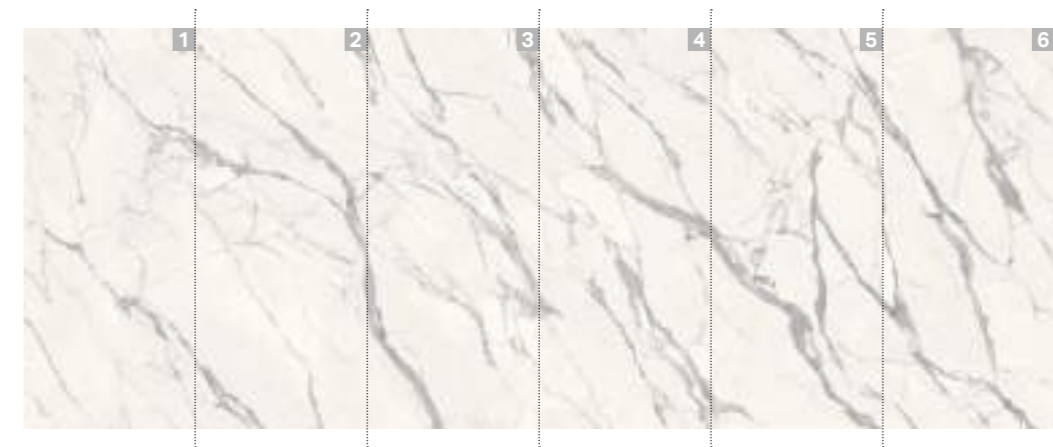

Composition with 6 continuous vein tiles size 120x280 sp 6 mm _48"x110" thk 6 mm available with natural rectified or lapped rectified finish.
Composition de 6 plaques à veines continues format 120x280 ép. 6 Mm disponible avec finition naturelle rectifiée ou rodée rectifiée.
Zusammenstellung aus 6 st. Platten mit durchgehender marmorierung, format 120x280, st. 6 Mm _48"x110" thk 6 mm verfügbar mit finish natur geschliffen oder geläpft geschliffen.

Le lastre sono fornite con le grafiche random. Possono essere fornite con **composizione a vena continua** con una maggiorazione nel prezzo e solo su richiesta esplicita del cliente.

The tiles are supplied with random graphics. They may be supplied with continuous vein effect at an additional charge and only if specifically requested by the customer.
Les plaques sont fournies avec graphiques aléatoires. Elles sont disponibles dans la composition à nervures continues avec une majoration sur le prix et seulement sur demande explicite du client.
Die platten werden mit zufälliger marmorierung geliefert. Sie können auf ausdrücklichen wunsch des kunden gegen aufpreis auch mit einer durchgehenden marmorierung geliefert werden.

Il disegno riprodotto è indicativo. La **grafica di chain** può mostrare discontinuità di vena nel passaggio da una lastra all'altra. Per questo motivo **differenze fino a 3 cm** devono essere considerate come caratteristica del prodotto.

The drawing is purely illustrative. The graphic design of chain may result in discontinuities in the veining between panels. Discontinuities of up to 3 cm are not defects, but are characteristic of the product.
Le dessin reproduit est indicatif. De même que le matériau naturel, le graphisme de chain peut présenter des marbrures discontinues d'une dalle à l'autre. Pour cette raison, les différences jusqu'à 3 cm doivent être considérées comme une caractéristique du produit.
Die wiedergegebene zeichnung ist eine musterzeichnung. Wie für das natürliche material kann auch die grafik von chain brüche der aderungen beim übergang von einer platte zur andern aufweisen. Aus diesem grund sind unterschiede bis zu 3 cm als charakteristik des produkts zu betrachten.

Statuario Reale

6 mm					8,8 mm		
160x320 63"x126"		120x280 48"x110"		120x120 48"x48"	R 10 A naturale		60x120 24"x48"
Nat Ret	Lap Ret	Nat Ret	Lap Ret	Lap Ret	Nat Ret	Lap Ret	
163008	163007	163018	163017	163027	163108	163107	
Price code	M173 M197	M153 M175	M169		M109	M125	

Pezzi Speciali / Trims. Pièces speciale. Die Sonderstücke

6 mm							
Gradino costa retta** Straight-edge stair**				Gradino costa retta SX - DX** Straight-edge step L-R corner**			
33x160		33x120		33x160		33x120	
Nat Ret	Lap Ret	Nat Ret	Lap Ret	Nat Ret	Lap Ret	Nat Ret	Lap Ret
163355	163365	163358	163368	163356 SX 163357 DX	163366 SX 163367 DX	163359 SX 163360 DX	163369 SX 163354 DX
Price code	P303 P323	P243 P265	P319 P339	P273 P283			

8,8 mm							
R 10 A naturale		Battiscopa Skirting		Gradino costa retta** Straight-edge stair**		Gradino costa retta SX - DX** Straight-edge step L-R corner**	
6,5x120		33x120		33x120			
Nat Ret	Lap Ret	Nat Ret	Lap Ret	Nat Ret	Lap Ret		
163214	163213	163346	163361	163349 SX 163352 DX	163362 SX 163363 DX		
Price code	P040 P043	P207 P215	P231 P243				

Wall
Statuario Reale 160x320_63"x126" Lap Ret

Imballi / Packings. Emballage. Verpackung

	PCS/BOX	MQ/BOX	KG/BOX	PCS/PAL	BOX/PAL	MQ/PAL	KG/PAL	PACKING	PACKING SIZE	TARE (KG)
6 mm										
160 x 320	-	-	-	14	-	71,68	1.178	CASSA	345 x 175 x 37h	140
	-	-	-	44	-	225,28	3.440	CAVALLETTO LEGNO	330 x 75 x 193,5h	177,50
120 x 280	-	-	-	20	-	67,20	1.081	CASSA	292 x 145 x 35h	108
	-	-	-	44	-	147,84	2.350	CAVALLETTO LEGNO	290 x 75 x 161h	145
120 x 120	2	2,88	41,70	-	24	69,12	1.041	PALLET SPECIALE	123 x 143 x 74h	29
8,8 mm										
60 x 120 Nat	2	1,44	26,78	-	32	46,08	879	EPAL	80 x 120	22
60 x 120 Lap	2	1,44	32,54	-	30	43,20	998	EPAL	80 x 120	22

Cavalletto in legno
Wood A-Frame. Support en bois.
Holzgestell

Cassa
Crate . Caisse . Kiste

Pallet speciale con sponde
Special pallet with sides .
Palette spéciale avec bords.
Spezial-Palette mit Wandungen.

Epal/Pallet

Pezzi Speciali / Trims	PCS/BOX	MQ/BOX	KG/BOX	PACKING	PACKING SIZE
6 mm					
GRADINO COSTA RETTA 33 x 160 x 3,2h **	1	-	9	PALLET SPECIALE	168 x 97 x 40,9h
GRADINO COSTA RETTA 33 x 160 x 3,2h SX/DX **	1	-	10	PALLET SPECIALE	168 x 97 x 40,9h
GRADINO COSTA RETTA 33 x 120 x 3,2h **	2	-	14	PALLET	80 x 120
GRADINO COSTA RETTA 33 x 120 x 3,2h SX/DX **	1	-	7	PALLET	80 x 120
8,8 mm					
BATTISCOPA 6,5 x 120	6	-	11,40	PALLET	80 x 120
GRADINO COSTA RETTA 33 x 120 x 3,2h **	2	-	20,70	PALLET	80 x 120
GRADINO COSTA RETTA 33 x 120 x 3,2h SX/DX **	1	-	10,80	PALLET	80 x 120

**** A disposizione solo su richiesta. Tempi di consegna: 30gg**
Available upon request only. Delivery terms: 30 days
Disponibile seulement sur requête. Délais de livraison: 30 jours
Verfügbar auf Anfrage. Lieferzeit: 30 Tage

Calacatta

MARMO E PIETRA

< FITTING ROOMS
< LIFT
< STAIRS

Calacatta

6 mm



160x320
63"x126"
Nat Ret
Lap Ret



120x280
48"x110"
Nat Ret
Lap Ret



120x120
48"x48"
Nat Ret
Lap Ret

Decoro / Decor



Mosaico 30x30
12"x12"
Nat Ret
Lap Ret



Slab A
160x320
63"x126"
Lap Ret



Slab B
160x320
63"x126"
Lap Ret

8,8 mm



60x120
24"x48"
Nat Ret
Lap Ret



60x60
24"x24"
Nat Ret
Lap Ret

— modular system —

Sviluppo grafico per formato
Pattern by size
Développement graphique par format
Grafischer Entwurf für Format



160x320
6 mm

7

160x320
6 mm

2
SlabA/B

120x280
6 mm

11

120x120
6 mm

22

60x120
8,8 mm

20

60x60
8,8 mm

26

Sviluppo Grafico

Pattern by size. Développement graphique par format. Grafischer Entwurf für Format

160x320 6 mm



7 patterns

Macchia aperta

Book match. Taches ouvertes. Offen Flecken.

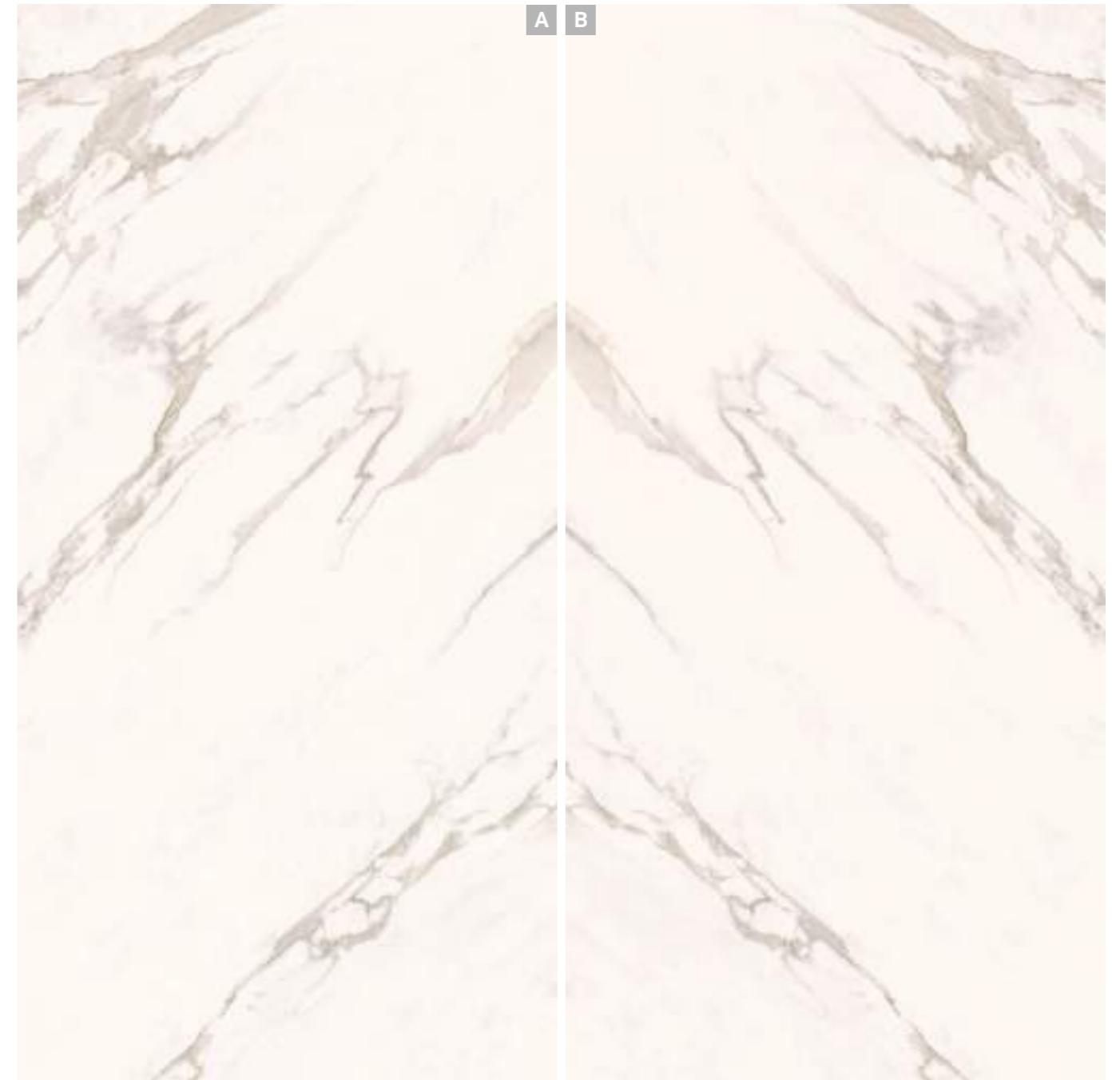

Esempio 1 / Example 1



Esempio 2 / Example 2

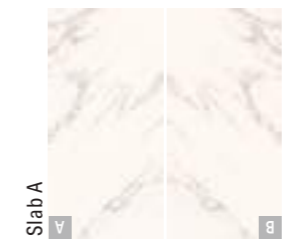

Esempio 3 / Example 3



Esempio 4 / Example 4



Calacatta

6 mm	160x320 63"x126"		120x280 48"x110"		120x120 48"x48"		Mosaico 30x30 12"x12"	
	Nat Ret	Lap Ret	Nat Ret	Lap Ret	Nat Ret	Lap Ret	Nat Ret	Lap Ret
	083006	083005	083018	083028	083036	083035	083196	083195
Price code	M173	M197	M153	M175	M141	M169	M193	M235

6 mm	160x320 63"x126"		60x120 24"x48"		60x60 24"x24"	
	Lap Ret		Nat Ret	Lap Ret	Nat Ret	Lap Ret
	083093 A 083094 B		083066	083065	083086	083085
Price code	M197		M109	M125	M089	M113

Pezzi Speciali / Trims. Pièces speciale. Die Sonderstücke

6 mm	Gradino costa retta** Straight-edge stair**		Gradino costa retta SX - DX** Straight-edge step L-R corner**	
	33x120		33x120	
	Nat Ret	Lap Ret	Nat Ret	Lap Ret
	083264	083265	083344 SX 083304 DX	083345 SX 083305 DX
Price code	P243	P265	P273	P283

8,8 mm	Battiscopa Skirting		Gradino costa retta** Straight-edge stair**		Gradino costa retta SX - DX** Straight-edge step L-R corner**	
	6,5x120		33x120		33x120	
	Nat Ret	Lap Ret	Nat Ret	Lap Ret	Nat Ret	Lap Ret
	083216	083215	083286	083285	083364 SX 083324 DX	083365 SX 083325 DX
Price code	P040	P043	P207	P215	P231	P243



Wall & Floor
Calacatta 160x320_63"x126" Lap Ret

Imballi / Packings. Emballage. Verpackung

6 mm	PCS/BOX	MQ/BOX	KG/BOX	PCS/PAL	BOX/PAL	MQ/PAL	KG/PAL	PACKING	PACKING SIZE	TARE (KG)	
160 x 320 + SLAB A/B	-	-	-	14	-	71,68	1.178	CASSA	345 x 175 x 37h	140	
	-	-	-	44	-	225,28	3.472	CAVALLETTO LEGNO	330 x 75 x 193,5h	210	
	-	-	-	20	-	67,20	1.081	CASSA	292 x 145 x 35h	108	
120 x 280	-	-	-	44	-	147,84	2350	CAVALLETTO LEGNO	290 x 75 x 161h	145	
120 x 120	2	2,88	41,70	-	24	69,12	1.041	PALLET SPECIALE	123 x 143 x 74h	29	
MOSAICO 30 x 30	9	0,81	11,9	-	60	48,60	716	EPAL	80 x 120	22	
8,8 mm	60 x 120 Nat	2	1,44	27,9	-	32	46,08	895	EPAL	80 x 120	22
	60 x 120 Lap	2	1,44	27,9	-	30	43,20	839	EPAL	80 x 120	22
	60 x 60	3	1,08	21	-	40	43,20	842	EPAL	80 x 120	22

Cavalletto in legno
Wood A-Frame. Support en bois.
Holzgestell

Cassa
Crate . Caisse . Kiste

Pallet speciale con sponde
Special pallet with sides.
Palette spéciale avec bords.
Spezial-Palette mit Wandungen.

EPAL/Pallet

PEZZI SPECIALI. TRIMS	PCS/BOX	MQ/BOX	KG/BOX	PACKING	PACKING SIZE
6 mm					
GRADINO COSTA RETTA 33 x 120 x 3,2h **	2	-	14	PALLET	80 x 120
GRADINO COSTA RETTA 33 x 120 x 3,2h SX/DX **	1	-	7	PALLET	80 x 120
8,8 mm					
BATTISCOPA 6,5 x 120	6	-	11,40	PALLET	80 x 120
GRADINO COSTA RETTA 33 x 120 x 3,2h **	2	-	22	PALLET	80 x 120
GRADINO COSTA RETTA 33 x 120 x 3,2h SX/DX **	1	-	11	PALLET	80 x 120

** A disposizione solo su richiesta. Tempi di consegna: 30gg
Available upon request only. Delivery terms: 30 days
Disponible seulement sur requête. Délais de livraison: 30 jours
Verfügbar auf Anfrage. Lieferzeit: 30 Tage

Calacatta Oro

Calacatta Oro

MARMO E PIETRA



V3
SHADE SPECTRUM
HIGH

ISO 13006 - G - Bla_E ≤ 0,5% - UNI EN 14411 - UGL
ANSI A - 326.3: 2021
WET DYNAMIC COEFFICIENT OF FRICTION

DCOF ≥ 0,42
naturale

100 % DESIGN AND
PRODUCTION OF ITALY

Calacatta Oro
MARMO E PIETRA

6 mm



160x320
63"x126"
Nat Ret
Lap Ret



120x280
48"x110"
Nat Ret
Lap Ret



120x120
48"x48"
Lap Ret

8,8 mm **R10A naturale**



60x120
24"x48"
Nat Ret
Lap Ret

Sviluppo grafico per formato
Pattern by size
Développement graphique par format
Grafischer Entwurf für Format



160x320
6 mm

4

120x280
6 mm

4

120x120
6 mm

8

60x120
8,8 mm

21

Sviluppo Grafico

Pattern by size. Développement graphique par format. Grafischer Entwurf für Format.

160x320 6 mm

4 patterns



Wall
Calacatta Oro Slab A/B Lap 12 mm

Bathtub
Calacatta Oro Lap 20 mm

Floor
Calacatta Oro 160x320_63"x126" Lap Ret

Calacatta Oro

6 mm

	160x320 63"x126"		120x280 48"x110"		120x120 48"x48"
	Nat Ret	Lap Ret	Nat Ret	Lap Ret	Lap Ret
	163006	163005	163016	163015	163025
Price code	M173	M197	M153	M175	M169

8,8 mm
R10A naturale

	60x120 24"x48"	
	Nat Ret	Lap Ret
	163106	163105
Price code	M109	M125

Pezzi Speciali / Trims. Pièces speciale. Die Sonderstücke

6 mm

	33x160		33x120		33x160		33x120	
	Nat Ret	Lap Ret	Nat Ret	Lap Ret	Nat Ret	Lap Ret	Nat Ret	Lap Ret
	163337	163331	163340	163334	163338 SX 163339 DX	163332 SX 163333 DX	163341 SX 163342 DX	163335 SX 163336 DX
Price code	P303	P323	P243	P265	P319	P339	P273	P283

8,8 mm
R10A naturale

	6,5x120		33x120		33x120	
	Nat Ret	Lap Ret	Nat Ret	Lap Ret	Nat Ret	Lap Ret
	163210	163209	163353	163343	163348 SX 163351DX	163364 SX 163345 DX
Price code	P040	P043	P207	P215	P231	P243



Wall
Calacatta Oro 160x320_63"x126" Lap Ret

Imballi / Packings. Emballage. Verpackung

	PCS/BOX	MQ/BOX	KG/BOX	PCS/PAL	BOX/PAL	MQ/PAL	KG/PAL	PACKING	PACKING SIZE	TARE (KG)
6 mm										
160 x 320	-	-	-	14	-	71,68	1.178	CASSA	345 x 175 x 37h	140
	-	-	-	44	-	225,28	3.472	CAVALLETTO LEGNO	330 x 75 x 193,5h	210
120 x 280	-	-	-	20	-	67,20	1.081	CASSA	292 x 145 x 35h	108
	-	-	-	44	-	147,84	2.285	CAVALLETTO LEGNO	290 x 75 x 161h	145
120 x 120	2	2,88	41,70	-	24	69,12	1.041	PALLET SPECIALE	123 x 143 x 74h	29
8,8 mm										
60 x 120 Nat	2	1,44	26,68	-	32	46,08	875	EPAL	80 x 120	22
60 x 120 Lap	2	1,44	32,54	-	30	43,20	998	EPAL	80 x 120	22



Cavalletto in legno
Wood A-Frame. Support en bois.
Holzgestell



Cassa
Crate. Caisse. Kiste



Pallet speciale con sponde
Special pallet with sides.
Palette spéciale avec bords.
Spezial-Palette mit Wandungen.



Epal/Pallet

PEZZI SPECIALI. TRIMS	PCS/BOX	MQ/BOX	KG/BOX	PACKING	PACKING SIZE
6 mm					
GRADINO COSTA RETTA 33 x 160 x 3,2h **	1	-	9	PALLET SPECIALE	168 x 97 x 40,9h
GRADINO COSTA RETTA 33 x 160 x 3,2h SX/DX **	1	-	10	PALLET SPECIALE	168 x 97 x 40,9h
GRADINO COSTA RETTA 33 x 120 x 3,2h **	2	-	14	PALLET	80 x 120
GRADINO COSTA RETTA 33 x 120 x 3,2h SX/DX **	1	-	7	PALLET	80 x 120
8,8 mm					
BATTISCOPA 6,5 x 120	6	-	11,40	PALLET	80 x 120
GRADINO COSTA RETTA 33 x 120 x 3,2h **	2	-	20,70	PALLET	80 x 120
GRADINO COSTA RETTA 33 x 120 x 3,2h SX/DX **	1	-	10,80	PALLET	80 x 120

** A disposizione solo su richiesta. Tempi di consegna: 30gg
Available upon request only. Delivery terms: 30 days
Disponible seulement sur requête. Délais de livraison: 30 jours
Verfügbar auf Anfrage. Lieferzeit: 30 Tage



Macchia Antica

Macchia Antica
MARMO E PIETRA



V3
SHADE SPECTRUM
HIGH

ISO 13006 - G - Bla_E ≤ 0,5% - UNI EN 14411 - UGL
ANSI A - 326.3: 2021
WET DYNAMIC COEFFICIENT OF FRICTION

DCOF ≥ 0,42
naturale

100 % DESIGN AND
PRODUCTION OF ITALY

Macchia Antica
MARMO E PIETRA

6 mm



160x320
63"x126"
Nat Ret
Lap Ret



120x280
48"x110"
Nat Ret
Lap Ret



120x120
48"x48"
Lap Ret

8,8 mm **R10A naturale**



60x120
24"x48"
Nat Ret
Lap Ret

Sviluppo grafico per formato
Pattern by size
Développement graphique par format
Grafischer Entwurf für Format



160x320
6 mm
5

120x280
6 mm
5

120x120
6 mm
10

60x120
8,8 mm
23

Sviluppo Grafico

Pattern by size. Développement graphique par format. Grafischer Entwurf für Format

160x320 6 mm



5 patterns

Composizione a vena continua

Continuous vein effect. Composition à nervures continues. Durchgehender marmorierung

COMPOSIZIONE DI 5 LASTRE A VENA CONTINUA FORMATO 160x320 SP 6 MM_63"x126" THK 6 MM
DISPONIBILE CON FINITURA NATURALE RETTIFICATA OPPURE LAPPATA RETTIFICATA



Composition with 5 continuous vein tiles size 160x320 thk 6 mm_63"x126" thk 6 mm available with natural rectified or lapped rectified finish.
Composition de 5 plaques à veines continues format 160x320 ép. 6 Mm disponible avec finition naturelle rectifiée ou rodée rectifiée.
Zusammenstellung aus 5 st. Platten mit durchgehender marmorierung, format 160x320, st. 6 Mm_126"x63" thk 6 mm verfügbar mit finish natur geschliffen oder geläpft geschliffen.

COMPOSIZIONE DI 5 LASTRE A VENA CONTINUA FORMATO 120x280 SP 6 MM_48"x110" THK 6 MM
DISPONIBILE CON FINITURA NATURALE RETTIFICATA OPPURE LAPPATA RETTIFICATA



Composition with 5 continuous vein tiles size 120x280 sp 6 mm_48"x110" thk 6 mm available with natural rectified or lapped rectified finish.
Composition de 5 plaques à veines continues format 120x280 ép. 6 Mm disponible avec finition naturelle rectifiée ou rodée rectifiée.
Zusammenstellung aus 5 st. Platten mit durchgehender marmorierung, format 120x280, st. 6 Mm_48"x110" thk 6 mm verfügbar mit finish natur geschliffen oder geläpft geschliffen.

Le lastre sono fornite con le grafiche random. Possono essere fornite con **composizione a vena continua** con una maggiorazione nel prezzo e solo su richiesta esplicita del cliente.

The tiles are supplied with random graphics. They may be supplied with continuous vein effect at an additional charge and only if specifically requested by the customer.
Les plaques sont fournies avec graphiques aléatoires. Elles sont disponibles dans la composition à nervures continues avec une majoration sur le prix et seulement sur demande explicite du client.
Die platten werden mit zufälliger marmorierung geliefert. Sie können auf ausdrücklichen wunsch des kunden gegen aufpreis auch mit einer durchgehenden marmorierung geliefert werden.

Il disegno riprodotto è indicativo. La **grafica di chain** può mostrare discontinuità di vena nel passaggio da una lastra all'altra. Per questo motivo **differeze fino a 3 cm** devono essere considerate come caratteristica del prodotto.

The drawing is purely illustrative. The graphic design of chain may result in discontinuities in the veining between panels. Discontinuities of up to 3 cm are not defects, but are characteristic of the product.
Le dessin reproduit est indicatif. De même que le matériau naturel, le graphisme de chain peut présenter des marbrures discontinues d'une dalle à l'autre. Pour cette raison, les différences jusqu'à 3 cm doivent être considérées comme une caractéristique du produit.
Die wiedergegebene zeichnung ist eine musterzeichnung. Wie für das natürliche material kann auch die grafik von chain brüche der aderungen beim übergang von einer platte zur andern aufweisen. Aus diesem grund sind unterschiede bis zu 3 cm als charakteristik des produkts zu betrachten.

Macchia Antica

6 mm

	160x320 63"x126"		120x280 48"x110"		120x120 48"x48"
	Nat Ret	Lap Ret	Nat Ret	Lap Ret	Lap Ret
	163004	163003	163014	163013	163023
Price code	M173	M197	M153	M175	M169

8,8 mm
R 10 A
naturale

	Nat Ret	Lap Ret
	163104	163103
Price code	M109	M125

Pezzi Speciali / Trims. Pièces speciale. Die Sonderstücke

6 mm

	33x160		33x120		33x160		33x120	
	Nat Ret	Lap Ret	Nat Ret	Lap Ret	Nat Ret	Lap Ret	Nat Ret	Lap Ret
	163322	163316	163325	163319	163323 SX 163324 DX	163317 SX 163318 DX	163326 SX 163327 DX	163320 SX 163321 DX
Price code	P303	P323	P243	P265	P319	P339	P273	P283

8,8 mm
R 10 A
naturale

	6,5x120		33x120		33x120	
	Nat Ret	Lap Ret	Nat Ret	Lap Ret	Nat Ret	Lap Ret
	163207	163206	163344	163328	163347 SX 163350 DX	163329 SX 163330 DX
Price code	P040	P043	P207	P215	P231	P243



Backsplash / Counter top
Macchia Antica Lap

Forniture
Metal Corten Nat

Imballi / Packings. Emballage. Verpackung

	PCS/BOX	MQ/BOX	KG/BOX	PCS/PAL	BOX/PAL	MQ/PAL	KG/PAL	PACKING	PACKING SIZE	TARE (KG)
6 mm										
160 x 320	-	-	-	14	-	71,68	1.178	CASSA	345 x 175 x 37h	140
	-	-	-	44	-	225,28	3.472	CAVALLETTO LEGNO	330 x 75 x 193,5h	210
120 x 280	-	-	-	20	-	67,20	1.081	CASSA	292 x 145 x 35h	108
	-	-	-	44	-	147,84	2.285	CAVALLETTO LEGNO	290 x 75 x 161h	145
120 x 120	2	2,88	41,70	-	24	69,12	1.041	PALLET SPECIALE	123 x 143 x 74h	29
8,8 mm										
60 x 120 Nat	2	1,44	26,9	-	32	46,08	882	EPAL	80 x 120	22
60 x 120 Lap	2	1,44	32,5	-	30	43,20	998	EPAL	80 x 120	22



Cavalletto in legno
Wood A-Frame. Support en bois.
Holzgestell



Cassa
Crate. Caisse. Kiste



Pallet speciale con sponde
Special pallet with sides.
Palette spéciale avec bords.
Spezial-Palette mit Wandungen.



Epal/Pallet

PEZZI SPECIALI. TRIMS	PCS/BOX	MQ/BOX	KG/BOX	PACKING	PACKING SIZE
6 mm					
GRADINO COSTA RETTA 33 x 160 x 3,2h **	1	-	9	PALLET SPECIALE	168 x 97 x 40,9h
GRADINO COSTA RETTA 33 x 160 x 3,2h SX/DX **	1	-	10	PALLET SPECIALE	168 x 97 x 40,9h
GRADINO COSTA RETTA 33 x 120 x 3,2h **	2	-	14	PALLET	80 x 120
GRADINO COSTA RETTA 33 x 120 x 3,2h SX/DX **	1	-	7	PALLET	80 x 120
8,8 mm					
BATTISCOPA 6,5 x 120	6	-	11,40	PALLET	80 x 120
GRADINO COSTA RETTA 33 x 120 x 3,2h **	2	-	20,70	PALLET	80 x 120
GRADINO COSTA RETTA 33 x 120 x 3,2h SX/DX **	1	-	10,80	PALLET	80 x 120

** A disposizione solo su richiesta. Tempi di consegna: 30gg
Available upon request only. Delivery terms: 30 days
Disponible seulement sur requête. Délais de livraison: 30 jours
Verfügbar auf Anfrage. Lieferzeit: 30 Tage

Breccia Argentum

Breccia Argentum

MARMO E PIETRA



V2
SHADE SPECTRUM
MODERATE

ISO 13006 - G - Bla_E ≤ 0,5% - UNI EN 14411 - UGL
ANSI A - 326.3: 2021
WET DYNAMIC COEFFICIENT OF FRICTION

DCOF ≥ 0,42
naturale

100 % DESIGN AND
PRODUCTION OF ITALY

Breccia Argentum
MARMO E PIETRA

6 mm



160x320
63"x126"
Nat Ret
Lap Ret



120x280
48"x110"
Nat Ret
Lap Ret



120x120
48"x48"
Lap Ret

8,8 mm



60x120
24"x48"
Lap Ret

Sviluppo grafico per formato
Pattern by size
Développement graphique par format
Grafischer Entwurf für Format



160x320
6 mm

4

120x280
6 mm

4

120x120
6 mm

8

60x120
8,8 mm

20

Sviluppo Grafico

Pattern by size. Développement graphique par format.
Grafischer Entwurf für Format.

160x320 6 mm

4 patterns



Wall
Breccia Argentum 160x320_63"x126" Nat Ret

Bar counter / Furniture
Breccia Argentum Lap Ret 20 mm

Floor
Breccia Argentum 160x320_63"x126" Lap Ret

Breccia Argentum

6 mm

	160x320 63"x126"		120x280 48"x110"		120x120 48"x48"
	Nat Ret	Lap Ret	Nat Ret	Lap Ret	Lap Ret
	163002	163001	163012	163011	163021
Price code	M173	M197	M153	M175	M169

8,8 mm

	60x120 24"x48"
	Lap Ret
	163101
Price code	M125

Pezzi Speciali / Trims. Pièces speciale. Die Sonderstücke

6 mm

	33x160		33x120		33x160		33x120	
	Nat Ret	Lap Ret	Nat Ret	Lap Ret	Nat Ret	Lap Ret	Nat Ret	Lap Ret
	163307	163301	163310	163304	163308 SX 163309 DX	163302 SX 163303 DX	163311 SX 163312 DX	163305 SX 163306 DX
Price code	P303	P323	P243	P265	P319	P339	P273	P283

8,8 mm

	6,5x120	33x120	33x120
	Lap Ret	Lap Ret	Lap Ret
	163203	163313	163314 SX 163315 DX
Price code	P043	P215	P243



Floor
Breccia Argentum 160x320_63"x126" Lap Ret

Imballi / Packings. Emballage. Verpackung

	PCS/BOX	MQ/BOX	KG/BOX	PCS/PAL	BOX/PAL	MQ/PAL	KG/PAL	PACKING	PACKING SIZE	TARE (KG)
6 mm										
160 x 320	-	-	-	14	-	71,68	1.178	CASSA	345 x 175 x 37h	140
	-	-	-	44	-	225,28	3.472	CAVALLETTO LEGNO	330 x 75 x 193,5h	210
120 x 280	-	-	-	20	-	67,20	1.081	CASSA	292 x 145 x 35h	108
	-	-	-	44	-	147,84	2.285	CAVALLETTO LEGNO	290 x 75 x 161h	145
120 x 120	2	2,88	41,70	-	24	69,12	1.041	PALLET SPECIALE	123 x 143 x 74h	29
8,8 mm										
60 x 120	2	1,44	27,9	-	30	43,20	839	EPAL	80 x 120	22



Cavalletto in legno
Wood A-Frame. Support en bois.
Holzgestell



Cassa
Crate. Caisse. Kiste



Pallet speciale con sponde
Special pallet with sides.
Palette spéciale avec bords.
Spezial-Palette mit Wandungen.



Epal

PEZZI SPECIALI. TRIMS	PCS/BOX	MQ/BOX	KG/BOX	PACKING	PACKING SIZE
6 mm					
GRADINO COSTA RETTA 33 x 160 x 3,2h **	1	-	9	PALLET SPECIALE	168x97x40,9h
GRADINO COSTA RETTA 33 x 160 x 3,2h SX/DX **	1	-	10	PALLET SPECIALE	168x97x40,9h
GRADINO COSTA RETTA 33 x 120x3,2h **	2	-	14	PALLET	80 x 120
GRADINO COSTA RETTA 33 x 120 x 3,2h SX/DX **	1	-	7	PALLET	80 x 120
8,8 mm					
BATTISCOPA 6,5x120	6	-	11,40	PALLET	80 x 120
GRADINO COSTA RETTA 33x120x3,2h **	2	-	20,70	PALLET	80 x 120
GRADINO COSTA RETTA 33x120x3,2h SX/DX **	1	-	10,80	PALLET	80 x 120

**** A disposizione solo su richiesta. Tempi di consegna: 30gg**
Available upon request only. Delivery terms: 30 days
Disponible seulement sur requête. Délais de livraison: 30 jours
Verfügbar auf Anfrage. Lieferzeit: 30 Tage

Bronze Amani

MARMO E PIETRA

*Bronze
Amani*

V2
SHADE SPECTRUM
MODERATE

ISO 13006 - G - Bla_E ≤ 0,5% - UNI EN 14411 - UGL
ANSI A - 326.3: 2021
WET DYNAMIC COEFFICIENT OF FRICTION

DCOF ≥ 0,42
naturale

100 % DESIGN AND
PRODUCTION OF ITALY

Bronze Amani
MARMO E PIETRA

6 mm



120x280
48"x110"
Lap Ret

Decoro / Decor



Mosaico 30x30
12"x12"
Lap Ret

8,8 mm **R10A naturale**



60x120
24"x48"
Nat Ret
Lap Ret

Sviluppo grafico per formato
Pattern by size
Développement graphique par format
Grafischer Entwurf für Format



120x280
6 mm

11

60x120
8,8 mm

13

Sviluppo Grafico

Pattern by size. Développement graphique par format.
Grafischer Entwurf für Format

120x280 6mm



11 patterns



Floor
Bronze Amani 120x280_48"x110" Lap Ret

Bronze Amani

6 mm



120x280
48"x110"

Lap Ret

148022

Price code **M175**



Mosaico 30x30
12"x12"

Lap Ret

148282

Price code **M235**

8,8 mm

R 10 A
naturale



60x120
24"x48"

Nat Ret Lap Ret

135071 135070

Price code **M109 M125**

Pezzi Speciali / Trims / Pièces speciale / Die Sonderstücke

8,8 mm

R 10 A
naturale



Battiscopa
Skirting

6,5x120

Nat Ret Lap Ret

135211 135210

Price code **P040 P043**

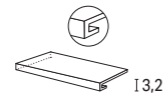

Gradino costa retta**
Straight-edge stair**

13,2 h

33x120

Nat Ret Lap Ret

135316 135346

Price code **P207 P215**

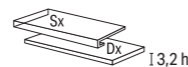

Gradino costa retta SX - DX**
Straight-edge step L-R corner**

13,2 h

33x120

Nat Ret Lap Ret

135318 SX 135317 DX 135348 SX 135347 DX

Price code **P231 P243**



Imballi / Packings. Emballage. Verpackung

	PCS/BOX	MQ/BOX	KG/BOX	PCS/PAL	BOX/PAL	MQ/PAL	KG/PAL	PACKING	PACKING SIZE	TARE (KG)
6 mm										
120 x 280	-	-	-	20	-	67,20	1.081	CASSA	292 x 145 x 35h	108
MOSAICO 30 x 30	9	0,81	11,90	-	60	48,60	716	EPAL	80 x 120	22
8,8 mm										
60 x 120 Nat	2	1,44	27,9	-	32	46,08	895	EPAL	80 x 120	22
60 x 120 Lap	2	1,44	27,9	-	30	43,20	839	EPAL	80 x 120	22



Cavalletto in legno
Wood A-Frame. Support en bois.
Holzgestell



Cassa
Crate . Caisse . Kiste



Epal

PEZZI SPECIALI. TRIMS	PCS/BOX	MQ/BOX	KG/BOX	PACKING	PACKING SIZE
8,8 mm					
BATTISCOPA 6,5 x 120	6	-	11	EPAL	80 x 120
GRADINO COSTA RETTA 33 x 120 x 3,2h **	2	-	23	EPAL	80 x 120
GRADINO COSTA RETTA 33 x 120 x 3,2h SX/DX **	1	-	12	EPAL	80 x 120

**** A disposizione solo su richiesta.**
Tempi di consegna: 30gg
Available upon request only. Delivery terms: 30 days
Disponible seulement sur requête. Délais de livraison: 30 jours
Verfügbar auf Anfrage. Lieferzeit: 30 Tage



*Traver
tino
Classic*

Travertino Classic

MARMO E PIETRA



ISO 13006 - G - Bla_E ≤ 0,5% - UNI EN 14411 - UGL
 ANSI A - 326.3: 2021
 WET DYNAMIC COEFFICIENT OF FRICTION



Travertino Classic

MARMO E PIETRA

6 mm



160x320
 63"x126"
 Nat Ret
 Lap Ret



120x280
 48"x110"
 Nat Ret
 Lap Ret

Decoro / Decor



Mosaico 30x30
 12"x12"
 Nat Ret
 Lap Ret

8,8 mm



60x120
 24"x48"
 Nat Ret
 Lap Ret

Sviluppo grafico per formato
 Pattern by size
 Développement graphique par format
 Grafischer Entwurf für Format



160x320
 6 mm

7

120x280
 6 mm

9

60x120
 8,8 mm

12

Sviluppo Grafico

Pattern by size. Développement graphique par format.
Grafischer Entwurf für Format.

160x320 6 mm



7 patterns



Wall
Travertino Classic 120x280_48"x110" Nat Ret

Floor
Travertino Classic 120x120_48"x48" Nat Ret

Travertino Classic

6 mm



160x320
63"x126"



120x280
48"x110"



Mosaico 30x30
12"x12"

	160x320 63"x126"		120x280 48"x110"		Mosaico 30x30 12"x12"	
	Nat Ret	Lap Ret	Nat Ret	Lap Ret	Nat Ret	Lap Ret
	138002	138001	138503	138502	138202	138201
Price code	M173	M197	M153	M175	M193	M235

8,8 mm



60x120
24"x48"

	Nat Ret	Lap Ret
	138014	138013
Price code	M109	M125

Pezzi Speciali / Trims. Pièces speciale. Die Sonderstücke

8,8 mm



Battiscopa
Skirting

6,5x120

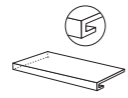

Gradino costa retta**
Straight-edge stair**

13,2h

33x120

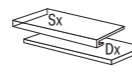

Gradino costa retta SX - DX**
Straight-edge step L-R corner**

13,2h

33x120

	6,5x120		33x120		33x120	
	Nat Ret	Lap Ret	Nat Ret	Lap Ret	Nat Ret	Lap Ret
	138104	138103	138132	138129	138134 SX 138133 DX	138131 SX 138130 DX
Price code	P040	P043	P207	P215	P231	P243



Wall
Travertino Classic 160x320_63"x126" Lap Ret

Imballi / Packings. Emballage. Verpackung

	PCS/BOX	MQ/BOX	KG/BOX	PCS/PAL	BOX/PAL	MQ/PAL	KG/PAL	PACKING	PACKING SIZE	TARE (KG)
6 mm										
160 x 320	-	-	-	14	-	71,68	1.178	CASSA	345 x 175 x 37h	140
	-	-	-	44	-	225,28	3.472	CAVALLETTO LEGNO	330 x 75 x 193,5h	210
120 x 280	-	-	-	20	-	67,20	1.081	CASSA	292 x 145 x 35h	108
	-	-	-	44	-	147,84	2.350	CAVALLETTO LEGNO	290 x 75 x 161h	145
MOSAICO 30 x 30	9	0,81	11,90	-	60	48,60	716	EPAL	80 x 120	22
8,8 mm										
60 x 120 Nat	2	1,44	27,9	-	32	46,08	895	EPAL	80 x 120	22
60 x 120 Lap	2	1,44	27,9	-	30	43,20	839	EPAL	80 x 120	22



Cavalletto in legno
Wood A-Frame. Support en bois.
Holzgestell



Cassa
Crate. Caisse. Kiste



Epal / Pallet

PEZZI SPECIALI. TRIMS	PCS/BOX	MQ/BOX	KG/BOX	PACKING	PACKING SIZE
8,8 mm					
BATTISCOPA 6,5 x 120	6	-	11,40	PALLET	80 x 120
GRADINO COSTA RETTA 33 x 120 x 3,2h **	2	-	22	PALLET	80 x 120
GRADINO COSTA RETTA 33 x 120 x 3,2h SX/DX **	1	-	11	PALLET	80 x 120

** A disposizione solo su richiesta. Tempi di consegna: 30gg
Available upon request only. Delivery terms: 30 days
Disponibile seulement sur requête. Délais de livraison: 30 jours
Verfügbar auf Anfrage. Lieferzeit: 30 Tage



*Aesthetica
Hegel*

Aesthetica Hegel

MARMO E PIETRA



ISO 13006 - G - Bla_E ≤ 0,5% - UNI EN 14411 - UGL
 ANSI A - 326.3: 2021
 WET DYNAMIC COEFFICIENT OF FRICTION



6 mm



160x320
 63"x126"
 Nat Ret
 Lap Ret



120x280
 48"x110"
 Nat Ret
 Lap Ret



120x120
 48"x48"
 Nat Ret
 Lap Ret

Decoro / Decor



Mosaico 30x30
 12"x12"
 Nat Ret
 Lap Ret

8,8 mm



60x120
 24"x48"
 Lap Ret

Sviluppo grafico per formato
 Pattern by size
 Développement graphique par format
 Grafischer Entwurf für Format



160x320
 6 mm

7

120x280
 6 mm

11

120x120
 6 mm

22

60x120
 8,8 mm

25

Sviluppo Grafico

Pattern by size. Développement graphique par format.
Grafischer Entwurf für Format.

160x320 6 mm



7 patterns



Aesthetica Hegel

6 mm

	160x320 63"x126"		120x280 48"x110"		120x120 48"x48"		Mosaico 30x30 12"x12"	
	Nat Ret	Lap Ret	Nat Ret	Lap Ret	Nat Ret	Lap Ret	Nat Ret	Lap Ret
	079002	079001	079569	079567	079032	079031	079142	079141
Price code	M173	M197	M153	M175	M141	M169	M193	M235

8,8 mm

	60x120 24"x48"
	Lap Ret
	079061
Price code	M125

Pezzi Speciali / Trims. Pièces speciale. Die Sonderstücke

6 mm

	Gradino costa retta** Straight-edge stair**		Gradino costa retta SX - DX** Straight-edge step L-R corner**	
	33x120		33x120	
	Nat Ret	Lap Ret	Nat Ret	Lap Ret
	079221	079253	079229 SX 079225 DX	079285 SX 079269 DX
Price code	P243	P265	P273	P283

8,8 mm

	Battiscopa Skirting	Gradino costa retta** Straight-edge stair**	Gradino costa retta SX - DX** Straight-edge step L-R corner**
	6,5x120	33x120	33x120
	Lap Ret	Lap Ret	Lap Ret
	079201	079261	079293 SX 079277 DX
Price code	P043	P215	P243



Wall & Top
Aesthetica Hegel 120x280_48"x110" Lap Ret

Imballi / Packings. Emballage. Verpackung

	PCS/BOX	MQ/BOX	KG/BOX	PCS/PAL	BOX/PAL	MQ/PAL	KG/PAL	PACKING	PACKING SIZE	TARE (KG)
6 mm										
160 x 320	-	-	-	14	-	71,68	1.178	CASSA	345 x 175 x 37h	140
	-	-	-	44	-	225,28	3.472	CAVALLETTO LEGNO	330 x 75 x 193,5h	210
120 x 280	-	-	-	20	-	67,20	1.081	CASSA	292 x 145 x 35h	108
	-	-	-	44	-	147,84	2.285	CAVALLETTO LEGNO	290 x 75 x 161h	145
120 x 120	2	2,88	41,70	-	24	69,12	1.041	PALLET SPECIALE	123 x 143 x 74h	29
MOSAICO 30 x 30	9	0,81	11,90	-	60	48,60	716	EPAL	80 x 120	22
8,8 mm										
60 x 120 Lap	2	1,44	27,9	-	30	43,20	839	EPAL	80 x 120	22



Cavalletto in legno
Wood A-Frame. Support en bois.
Holzgestell



Cassa
Crate. Caisse. Kiste



Pallet speciale con sponde
Special pallet with sides.
Palette spéciale avec bords.
Spezial-Palette mit Wandungen.



Epal / Pallet

PEZZI SPECIALI. TRIMS	PCS/BOX	MQ/BOX	KG/BOX	PACKING	PACKING SIZE
6 mm					
GRADINO COSTA RETTA 33 x 120 x 3,2h **	2	-	14	PALLET	80 x 120
GRADINO COSTA RETTA 33 x 120 x 3,2h SX/DX **	1	-	7	PALLET	80 x 120
8,8 mm					
BATTISCOPA 6,5 x 120	6	-	11,40	PALLET	80 x 120
GRADINO COSTA RETTA 33 x 120 x 3,2h **	2	-	22	PALLET	80 x 120
GRADINO COSTA RETTA 33 x 120 x 3,2h SX/DX **	1	-	11	PALLET	80 x 120

** A disposizione solo su richiesta. Tempi di consegna: 30gg
Available upon request only. Delivery terms: 30 days
Disponible seulement sur requête. Délais de livraison: 30 jours
Verfügbar auf Anfrage. Lieferzeit: 30 Tage

Aesthetica Wilde

MARMO E PIETRA

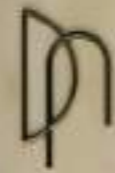

LUXE
BEAUTY
SUITES



*Aesthetica
Wilde*

V2
SHADE SPECTRUM
MODERATE

ISO 13006 - G - Bla_E ≤ 0,5% - UNI EN 14411 - UGL
ANSI A - 326.3: 2021
WET DYNAMIC COEFFICIENT OF FRICTION

DCOF ≥ 0,42
naturale

100% DESIGN AND
PRODUCTION OF ITALY

Aesthetica Wilde
MARMO E PIETRA

6 mm



160x320
63"x126"
Nat Ret
Lap Ret



120x280
48"x110"
Nat Ret
Lap Ret



120x120
48"x48"
Nat Ret
Lap Ret

Decoro / Decor



Mosaico 30x30
12"x12"
Nat Ret
Lap Ret

8,8 mm



60x120
24"x48"
Lap Ret

Sviluppo grafico per formato
Pattern by size
Développement graphique par format
Grafischer Entwurf für Format



160x320
6 mm

7

120x280
6 mm

11

120x120
6 mm

22

60x120
8,8 mm

26

Sviluppo Grafico

Pattern by size. Développement graphique par format.
Grafischer Entwurf für Format.

160x320 6 mm



7 patterns



Aesthetica Wilde

6 mm

	160x320 63"x126"		120x280 48"x110"		120x120 48"x48"		Mosaico 30x30 12"x12"	
	Nat Ret	Lap Ret	Nat Ret	Lap Ret	Nat Ret	Lap Ret	Nat Ret	Lap Ret
	079006	079005	079570	079568	079036	079035	079146	079145
Price code	M173	M197	M153	M175	M141	M169	M193	M235

8,8 mm

	60x120 24"x48"
	Lap Ret
	079065
Price code	M125

Pezzi Speciali / Trims. Pièces speciale. Die Sonderstücke

6 mm

	Gradino costa retta** Straight-edge stair**		Gradino costa retta SX - DX** Straight-edge step L-R corner**	
	33x120		33x120	
	Nat Ret	Lap Ret	Nat Ret	Lap Ret
	079222	079254	079230 SX 079226 DX	079286 SX 079270 DX
Price code	P243	P265	P273	P283

8,8 mm

	Battiscopa Skirting	Gradino costa retta** Straight-edge stair**	Gradino costa retta SX - DX** Straight-edge step L-R corner**
	6,5x120	33x120	33x120
	Lap Ret	Lap Ret	Lap Ret
	079202	079262	079294 SX 079278 DX
Price code	P043	P215	P243

LUXE
BEAUTY
SUITES



Wall & Floor
Aesthetica Wilde 120x280_48"x110" Lap Ret

Imballi / Packings. Emballage. Verpackung

	PCS/BOX	MQ/BOX	KG/BOX	PCS/PAL	BOX/PAL	MQ/PAL	KG/PAL	PACKING	PACKING SIZE	TARE (KG)
6 mm										
160 x 320	-	-	-	14	-	71,68	1.178	CASSA	345 x 175 x 37h	140
	-	-	-	44	-	225,28	3.472	CAVALLETTO LEGNO	330 x 75 x 193,5h	210
120 x 280	-	-	-	20	-	67,20	1.081	CASSA	292 x 145 x 35h	108
	-	-	-	44	-	147,84	2.285	CAVALLETTO LEGNO	290 x 75 x 161h	145
120 x 120	2	2,88	41,70	-	24	69,12	1.041	PALLET SPECIALE	123 x 143 x 74h	29
MOSAICO 30 x 30	9	0,81	11,90	-	60	48,60	716	EPAL	80 x 120	22
8,8 mm										
60 x 120 Lap	2	1,44	27,9	-	30	43,20	839	EPAL	80 x 120	22



Cavalletto in legno
Wood A-Frame. Support en bois.
Holzgestell



Cassa
Crate . Caisse . Kiste



Pallet speciale con sponde
Special pallet with sides.
Palette spéciale avec bords.
Spezial-Palette mit Wandungen.



Epal / Pallet

PEZZI SPECIALI. TRIMS	PCS/BOX	MQ/BOX	KG/BOX	PACKING	PACKING SIZE
6 mm					
GRADINO COSTA RETTA 33 x 120 x 3,2h **	2	-	14	PALLET	80 x 120
GRADINO COSTA RETTA 33 x 120 x 3,2h SX/DX **	1	-	7	PALLET	80 x 120
8,8 mm					
BATTISCOPA 6,5 x 120	6	-	11,40	PALLET	80 x 120
GRADINO COSTA RETTA 33 x 120 x 3,2h **	2	-	22	PALLET	80 x 120
GRADINO COSTA RETTA 33 x 120 x 3,2h SX/DX **	1	-	11	PALLET	80 x 120

** A disposizione solo su richiesta.
Tempi di consegna: 30gg
Available upon request only. Delivery
terms: 30 days
Disponibile seulement sur requête.
Délais de livraison: 30 jours
Verfügbar auf Anfrage. Lieferzeit:
30 Tage

Onice Iride

Onice Iride
MARMO E PIETRA

COBALTO

GIADA

ARGENTO

AVORIO

AMBRA

MALAGA

V3
SHADESPECTRUM
HIGH

ISO 13006 - G - Bla_E ≤ 0,5% - UNI EN 14411 - UGL

100% DESIGN AND
PRODUCTION OF ITALY

Onice Iride
MARMO E PIETRA

6 mm



160x320
63"x126"
Lap Ret



80x160
31 1/2"x63"
Lap Ret



120x280
48"x110"
Lap Ret



120x120
48"x48"
Lap Ret

modular system

8,8 mm



60x120
24"x48"
Lap Ret

Sviluppo grafico per formato
Pattern by size
Développement graphique par format
Grafischer Entwurf für Format



160x320
6 mm

4

120x280
6 mm

4

120x120
6 mm

8

80x160
6 mm

16

60x120
8,8 mm

24

Sviluppo Grafico

Pattern by size. Développement graphique par format.
Grafischer Entwurf für Format.

COBALTO 160x320 6 mm

4 patterns

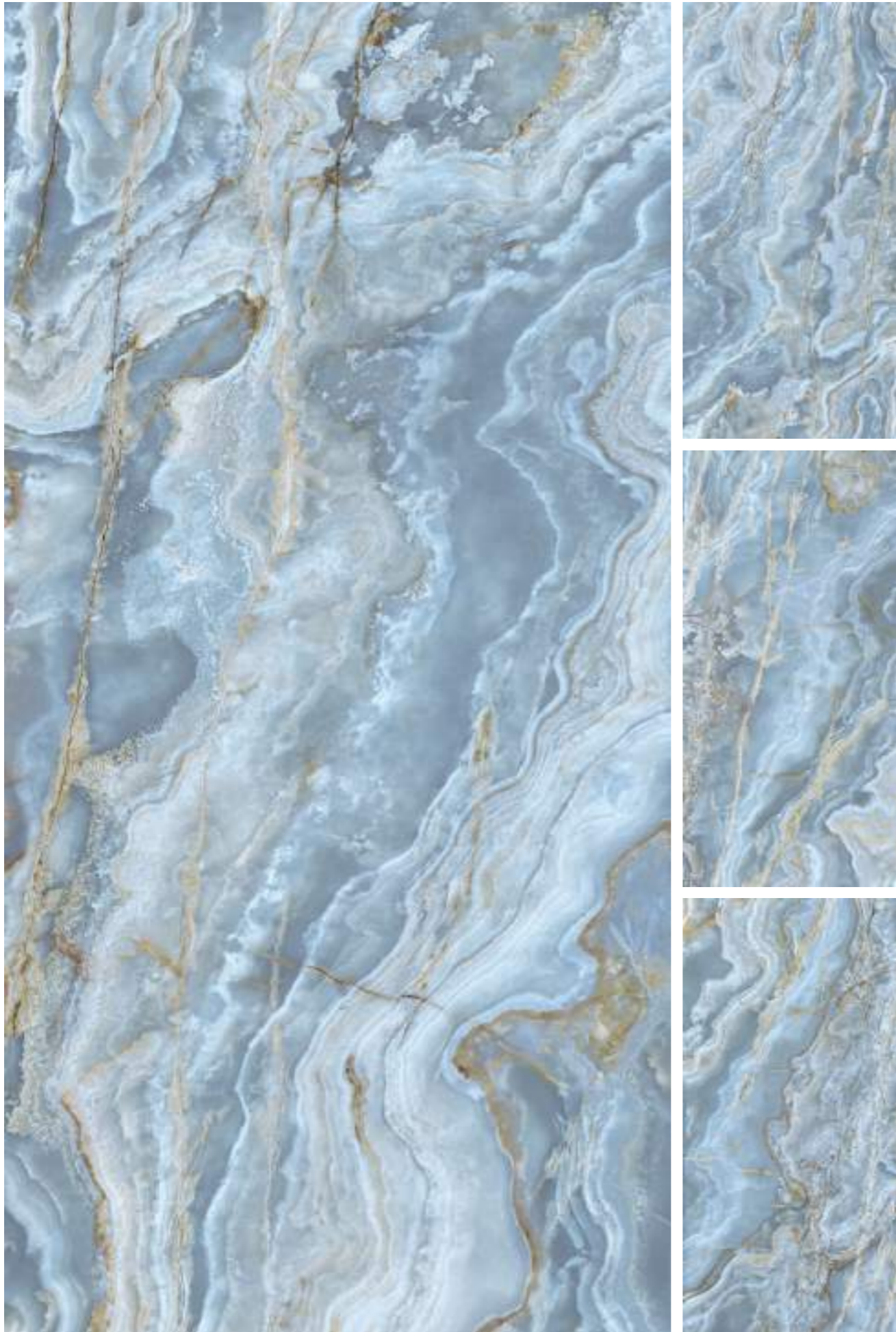

Wall
Onice Iride Cobalto 160x320_63"x126" Lap Ret

Floor
Hurban White 100x100_40"x40" Nat Ret

Onice Iride

6 mm

	160x320 63"x126"	80x160 31 1/2"x63"	120x280 48"x110"	120x120 48"x48"
	Lap Ret	Lap Ret	Lap Ret	Lap Ret
COBALTO	173005	173045	173025	173035
GIADA	-	-	173022	173032
ARGENTO	173006	173046	173026	173036
AVORIO	173001	173041	173021	173031
AMBRA	173004	173044	173024	173034
MALAGA	173003	173043	173023	173033
Price code	M197	M169	M175	M169

8,8 mm

	60x120 24"x48"
	Lap Ret
COBALTO	173065
GIADA	173062
ARGENTO	173066
AVORIO	173061
AMBRA	173064
MALAGA	173063
Price code	M125

Pezzi Speciali / Trims. Pièces speciale. Die Sonderstücke

6 mm

	33x160 Lap Ret	33x120 Lap Ret	33x160 Lap Ret	33x120 Lap Ret
COBALTO	173205	173225	173207 SX 173299 DX	173227 SX 173233 DX
GIADA	173202	173222	173208 SX 173214 DX	173228 SX 173234 DX
ARGENTO	173240	173226	173300 SX 173215 DX	173229 SX 173235 DX
AVORIO	173201	173221	173210 SX 173216 DX	173230 SX 173236 DX
AMBRA	173204	173224	173212 SX 173218 DX	173232 SX 173238 DX
MALAGA	173239	173223	173211 SX 173217 DX	173231 SX 173237 DX
Price code	P323	P265	P339	P283

8,8 mm

	6,5x120 Lap Ret	33x120 Lap Ret	33x120 Lap Ret
COBALTO	173115	173245	173247 SX 173253 DX
GIADA	173112	173242	173248 SX 173254 DX
ARGENTO	173116	173246	173249 SX 173255 DX
AVORIO	173111	173241	173250 SX 173256 DX
AMBRA	173114	173244	173252 SX 173258 DX
MALAGA	173113	173243	173251 SX 173257 DX
Price code	P043	P215	P243



Wall
Onice Iride Giada 120x280_48"x110" Lap Ret

Floor
Onice Iride Argento 120x280_48"x110" Lap Ret

Imballi / Packings. Emballage. Verpackung

	PCS/BOX	MQ/BOX	KG/BOX	PCS/PAL	BOX/PAL	MQ/PAL	KG/PAL	PACKING	PACKING SIZE	TARE (KG)
6 mm										
160 x 320	-	-	-	14	-	71,68	1.178	CASSA	345 x 175 x 37h	140
	-	-	-	44	-	225,28	3.472	CAVALLETTO LEGNO	330 x 75 x 193,5h	210
120 x 280	-	-	-	20	-	67,20	1.081	CASSA	292 x 145 x 35h	108
	-	-	-	44	-	147,84	2.285	CAVALLETTO LEGNO	290 x 75 x 161h	145
120 x 120	2	2,88	41,70	-	24	69,12	1.041	PALLET SPECIALE	123 x 143 x 74h	29
80 x 160	2	2,56	74,24	-	15	38,40	1.098	PALLET SPECIALE	168 x 97 x 40,9h	29,4
8,8 mm										
60 x 120 Lap	2	1,44	28,5	-	30	43,20	877	EPAL	80 x 120	22



Cavalletto in legno
Wood A-Frame. Support en bois.
Holzgestell



Cassa
Crate. Caisse. Kiste



Pallet speciale con sponde
Special pallet with sides.
Palette spéciale avec bords.
Spezial-Palette mit Wandungen.



Epal / Pallet

PEZZI SPECIALI. TRIMS	PCS/BOX	MQ/BOX	KG/BOX	PACKING	PACKING SIZE
6 mm					
GRADINO COSTA RETTA 33 x 160 x 3,2h **	1	-	9	PALLET SPECIALE	168 x 97 x 40,9h
GRADINO COSTA RETTA 33 x 160 x 3,2h SX/DX **	1	-	10	PALLET SPECIALE	168 x 97 x 40,9h
GRADINO COSTA RETTA 33 x 120 x 3,2h **	2	-	14	EPAL	80 x 120
GRADINO COSTA RETTA 33 x 120 x 3,2h SX/DX **	1	-	7	EPAL	80 x 120
8,8 mm					
BATTISCOPA 6,5 x 120	6	-	11,40	PALLET	80 x 120
GRADINO COSTA RETTA 33 x 120 x 3,2h **	2	-	22	PALLET	80 x 120
GRADINO COSTA RETTA 33 x 120 x 3,2h SX/DX **	1	-	11	PALLET	80 x 120

** A disposizione solo su richiesta. Tempi di consegna: 30gg
Available upon request only. Delivery terms: 30 days
Disponible seulement sur requête. Délais de livraison: 30 jours
Verfügbar auf Anfrage. Lieferzeit: 30 Tage

Nautilus

MARMO E PIETRA



Nautilus

6 mm



160x320
63"x126"
Lap Ret



120x280
48"x110"
Lap Ret



120x120
48"x48"
Lap Ret

Decoro / Decor



Mosaico 30x30
12"x12"
Lap Ret

Sviluppo grafico per formato
Pattern by size
Développement graphique par format
Grafischer Entwurf für Format



160x320
6 mm
6

120x280
6 mm
10

120x120
6 mm
20

Sviluppo Grafico

Pattern by size. Développement graphique par format.
Grafischer Entwurf für Format.

160x320 6 mm

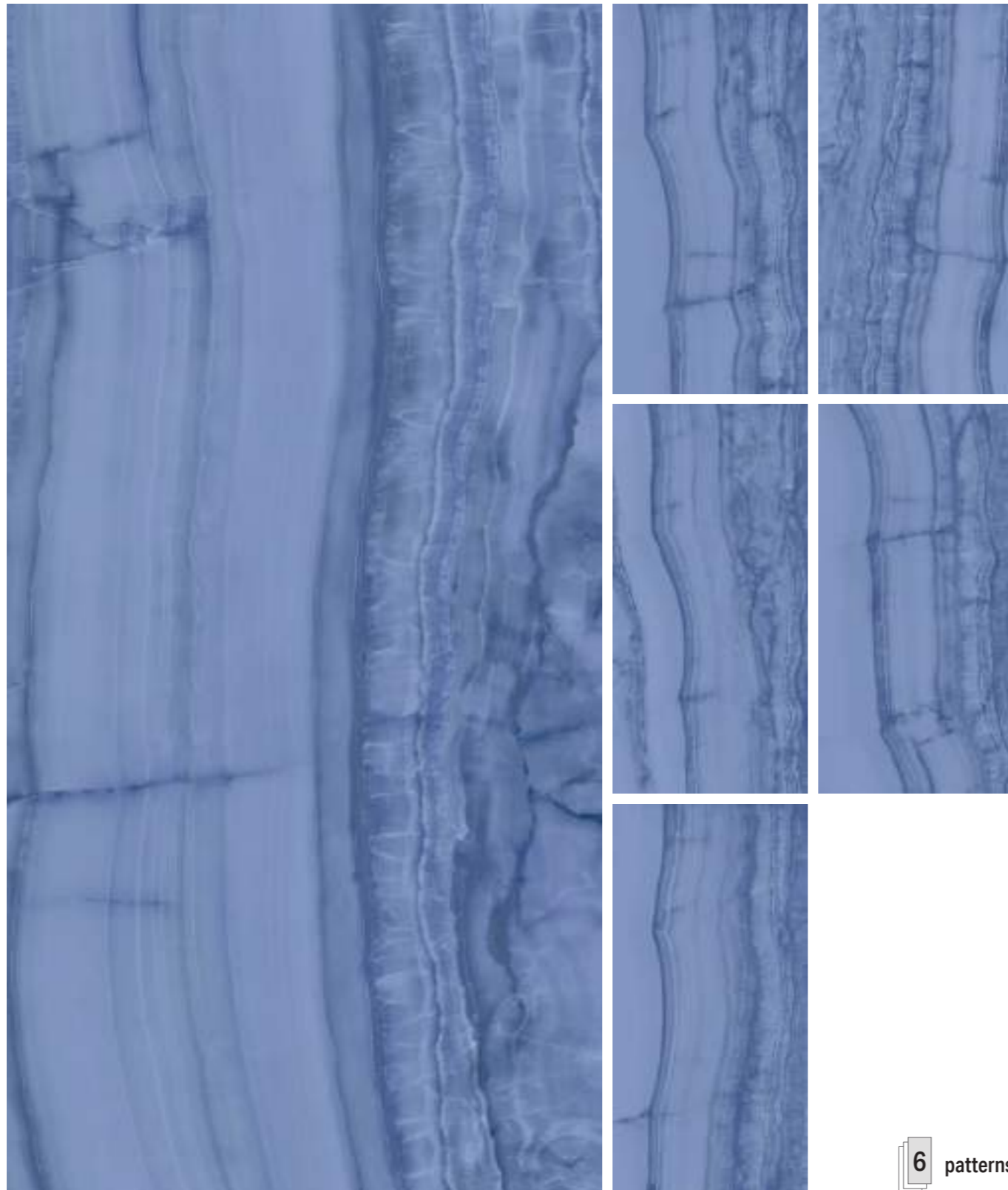

6 patterns

Nautilus

6 mm	160x320 63"x126"	120x280 48"x110"	120x120 48"x48"	Mosaico 30x30 12"x12"
	Lap Ret	Lap Ret	Lap Ret	Lap Ret
	113001	113050	113030	113302
Price code	M229	M207	M207	M269

Pezzi Speciali / Trims. Pièces speciale. Die Sonderstücke

6 mm	Gradino costa retta** Straight-edge stair**	Gradino costa retta SX - DX** Straight-edge step L-R corner**
	33x120	33x120
	Lap Ret	Lap Ret
	113210	113212 SX 113211 DX
Price code	P271	P285

Imballi / Packings. Emballage. Verpackung

6 mm	PCS/BOX	MQ/BOX	KG/BOX	PCS/PAL	BOX/PAL	MQ/PAL	KG/PAL	PACKING	PACKING SIZE	TARE (KG)
160 x 320	-	-	-	14	-	71,68	1.178	CASSA	345 x 175 x 37h	140
	-	-	-	44	-	225,28	3.472	CAVALLETTO LEGNO	330 x 75 x 193,5h	210
120 x 280	-	-	-	20	-	67,20	1.081	CASSA	292 x 145 x 35h	108
	-	-	-	44	-	147,84	2.285	CAVALLETTO LEGNO	290 x 75 x 161h	145
120 x 120	2	2,88	41,70	-	24	69,12	1.041	PALLET SPECIALE	123 x 143 x 74h	29
MOSAICO 30 x 30	9	0,81	11,90	-	60	48,60	716	EPAL	80 x 120	22



Cavalletto in legno
Wood A-Frame. Support en bois.
Holzgestell



Cassa
Crate. Caisse. Kiste



Pallet speciale con sponde
Special pallet with sides.
Palette spéciale avec bords.
Spezial-Palette mit Wandungen.



Epal / Pallet

PEZZI SPECIALI. TRIMS	PCS/BOX	MQ/BOX	KG/BOX	PACKING	PACKING SIZE
6 mm GRADINO COSTA RETTA 33 x 120 x 3,2h **	2	-	14	PALLET	80 x 120
GRADINO COSTA RETTA 33 x 120 x 3,2h SX/DX **	1	-	7	PALLET	80 x 120

** A disposizione solo su richiesta. Tempi di consegna: 30gg
Available upon request only. Delivery terms: 30 days
Disponible seulement sur requête. Délais de livraison: 30 jours
Verfügbar auf Anfrage. Lieferzeit: 30 Tage

Noble Stone



Noble Stone

MARMO E PIETRA

BEIGE

WHITE

GREY

TAUPE

DARK

V2
SHADE SPECTRUM
MODERATE

ISO 13006 - G - Bla_E ≤ 0,5% - UNI EN 14411 - UGL
ANSI A - 326.3: 2021
WET DYNAMIC COEFFICIENT OF FRICTION

DCOF ≥ 0,42
naturale

100 % DESIGN AND
PRODUCTION OF ITALY

Noble Stone
MARMO E PIETRA

6 mm

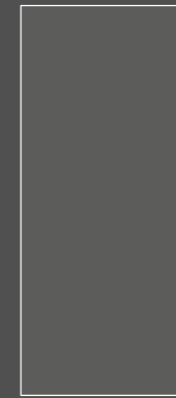

120x280
48"x110"
Nat Ret



120x120
48"x48"
Nat Ret

8,8 mm R10B

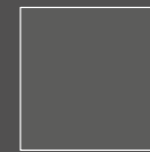

100x100
40"x40"
Nat Ret



60x120
24"x48"
Nat Ret
3D Satin Ret



60x60
24"x24"
Nat Ret



30x60
12"x24"
Nat Ret

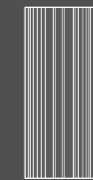

3D Stripes 60x120
24"x48"
Nat Ret

modular system

Decor / Decors



Mosaico 30x30
12"x12"
Nat Ret



Muretto 30x60
12"x24"
Nat Ret



Mosaico Modulo
30x30_12"x12"
Nat Ret



Basket 29,7x29,7
11 3/4"x11 3/4"
Nat Ret

8,8 mm OUTDOOR R11C



60x120
24"x48"
Nat Ret

Beige
Grey
Taupe

20 mm OUTDOOR R11C



60x120
24"x48"
Nat Ret

Beige
Grey
Taupe

Sviluppo grafico per formato
Pattern by size
Développement graphique par format
Grafischer Entwurf für Format



120x280
6 mm

4

120x120
6 mm

8

100x100
8,8 mm

12

60x120
8,8 mm

12

60x60
8,8 mm

24

30x60
8,8 mm

48

60x120
20 mm

12

Sviluppo Grafico

Pattern by size. Développement graphique par format.
Grafischer Entwurf für Format

GREY 120x280 6 mm



4 patterns



Wall
Noble Stone Grey 120x280_48"x110" Nat Ret

Counter
Noble Stone Muretto Grey 30x60_12"x24" Nat Ret

Floor
Noble Stone White 100x100_40"x40" Nat Ret

Decori

Decors

8,8 mm R10B

BEIGE



①

WHITE

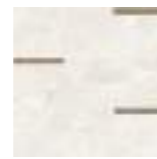

②

GREY



③

TAUPE

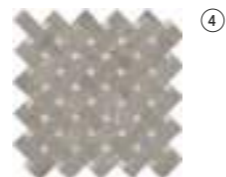

④

DARK

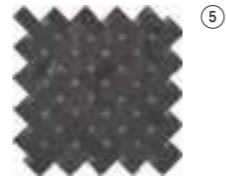
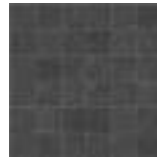

⑤

Mosaico 30x30
12"x12"
Nat Ret

Muretto 30x60 *
12"x24"
Nat Ret

Mosaico Modulo **
30x30_12"x12"
Nat Ret

Basket 29,7x29,7 ***
11 3/4"x11 3/4"
Nat Ret

* DECORO realizzato con inserti in finitura 3D Satin

Decor made with inserts in 3D Satin finishing.

Décor composé d'inserts en finition 3D satinée.

Dekor mit Einsätzen im 3D-Satin-Finish hergestellt.

** DECORO realizzato con la serie Jungle Stone Wild Lap e Noble Stone.

Decor made with Jungle Stone Wild Lap and Noble Stone series.

Décor composé de Jungle Stone Wild Lap et Noble Stone séries.

Dekor mit der Serie Jungle Stone Wild Lap und Noble Stone ausgeführt.

*** DECORO realizzato con la serie Ca' Foscari e Noble Stone.

Decoration made with Ca' Foscari and Noble Stone series.

Décor composé de Ca' Foscari et Noble Stone séries.

Dekor mit der Serie Ca' Foscari und Noble Stone ausgeführt.

① Ca' Foscari Tabacco / Noble Stone Beige

② Ca' Foscari Avana / Noble Stone White

③ Ca' Foscari Canapa / Noble Stone Grey

④ Ca' Foscari Canapa / Noble Stone Taupe

⑤ Ca' Foscari Moro / Noble Stone Dark

3D Stripes

8,8 mm R10B



3D Stripes 60x120
24"x48"
Nat Ret



Noble Stone

6 mm

	120x280 48"x110"	120x120 48"x48"
	Nat Ret	Nat Ret
BEIGE	199083	199093
WHITE	199081	199091
GREY	199082	199092
TAUPE	199085	199095
DARK	199084	199094
Price code	M153	M141

8,8 mm

R 10 B
naturale

	100x100 40"x40"	60x120 24"x48"	60x60 24"x24"	30x60 12"x24"
	Nat Ret	Nat Ret	3D Satin Ret	Nat Ret
BEIGE	199073	199003	199023	199053
WHITE	199071	199001	199021	199051
GREY	199072	199002	199022	199052
TAUPE	199075	199005	199025	199055
DARK	199074	199004	199024	199054
Price code	M109	M097	M129	M089

8,8 mm

R 11 C

	Gradino costa retta**** Straight nosed stair	Gradino costa retta SX - DX**** Straight-edge step L-R	Elemento a "L" incollato **** L-shaped element glued
	33x120	33x120	33x120
	Nat Ret	Nat Ret	Nat Ret
BEIGE	199193	199203 SX 199213 DX	199223
WHITE	-	-	-
GREY	199192	199202 SX 199212 DX	199222
TAUPE	199195	199205 SX 199215 DX	199225
DARK	-	-	-
Price code	P207	P239	P163

8,8 mm

R 10 B

	3D Stripes 60x120 24"x48"
	Nat Ret
BEIGE	199033
WHITE	199031
GREY	199032
TAUPE	199035
DARK	199034
Price code	M119

8,8 mm

R 10 B
naturale

	Mosaico 30x30 12"x12"	Muretto 30x60* 12"x24"	Mosaico Modulo 30x30** 12"x12"	Basket 29,7x29,7*** 11 3/4"x11 3/4"	60x120 24"x48"
	Nat Ret	Nat Ret	Nat Ret	Nat Ret	Nat Ret
BEIGE	199103	199123	199133	199113	199013
WHITE	199101	199121	199131	199111	-
GREY	199102	199122	199132	199112	199012
TAUPE	199105	199125	199135	199115	199015
DARK	199104	199124	199134	199114	-
Price code	M159	M187	M199	M207	M097

20 mm

R 11 C

	60x120 24"x48"
	Nat Ret
BEIGE	199043
WHITE	-
GREY	199042
TAUPE	199045
DARK	-
Price code	M131

Pezzi Speciali / Trims. Pièces speciale. Die Sonderstücke

8,8 mm

R 10 B
naturale

	Battiscopa Skirting	Gradino costa retta**** Straight nosed stair**	Gradino costa retta SX - DX**** Straight-edge step L-R
	7x100	7x60	33x120
	Nat Ret	Nat Ret	Nat Ret
BEIGE	199143	199153	199163
WHITE	199141	199151	199161
GREY	199142	199152	199162
TAUPE	199145	199155	199165
DARK	199144	199154	199164
Price code	P035	P021	P207

Imballi / Packings. Emballage. Verpackung

	PCS/BOX	MQ/BOX	KG/BOX	PCS/PAL	BOX/PAL	MQ/PAL	KG/PAL	PACKING	PACKING SIZE	TARE (KG)
6 mm										
120 x 280	-	-	-	20	-	67,20	974	CASSA	292 x 145 x 35h	108
120 x 120	-	-	-	44	-	147,84	2205	CAVALLETTO LEGNO	290 x 75 x 161h	145
	2	2,88	41,76	-	48	69,12	1003	PALLET CON SPONDE	123x 143 x 74h	29
8,8 mm										
100 x 100	2	2	38,3	-	24	48	913	PALLET CON SPONDE	103 x 123 x 74h	26
60 x 120	2	1,44	26,58	-	32	46,08	853	EPAL	80 x 120 x 75h	22
60 x 120 3D Satin	2	1,44	28	-	32	46,08	896	EPAL	80 x 120 x 75h	22
60 x 120 3D Stripes	2	1,44	28	-	32	46,08	896	EPAL	80 x 120 x 75h	22
60 x 120 R11C	2	1,44	26,53	-	32	46,08	849	EPAL	80 x 120 x 75h	22
60 x 60	3	1,08	20,60	-	40	43,20	824	EPAL	80 x 120 x 75h	22
30 x 60	7	1,26	24,6	-	48	60,48	1.155	EPAL	80 x 120 x 75h	22
DECORI. DECORS										
MOSAICO 30 x 30	6	0,54	10,36	-	60	32,40	621,6	EPAL	80 x 120	22
MURETTO 30 x 60 *	6	1,08	20,25	-	30	32,40	607,5	EPAL	80 x 120	22
MOSAICO MODULO 30 x 30 **	6	0,54	10,36	-	60	32,40	621,6	EPAL	80 x 120	22
BASKET 29,7 x 29,7 ***	6	0,53	10,36	-	60	31,80	621,6	EPAL	80 x 120	22
20 mm										
60 x 120 R11C	1	0,72	28	-	32	23,04	896	EPAL	80 x 120	22

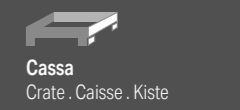

PEZZI SPECIALI. TRIMS

8,8 mm

	PCS/BOX	MQ/BOX	KG/BOX	PACKING	PACKING SIZE	TARE (KG)
BATTISCOPA 7 x 100	6	0,42	8,10	EPAL	80 x 120	22
BATTISCOPA 7 x 60	15	0,63	13,28	EPAL	80 x 120	22
GRADINO COSTA RETTA 33 x 120 x 3,2h ****	2	-	14	EPAL	80 x 120	22
GRADINO COSTA RETTA 33 x 120 x 3,2h SX/DX ****	1	-	7	EPAL	80 x 120	22
ELEMENTO A L INCOLLATO ****	2	-	20	EPAL	80 x 120	22

**** A disposizione solo su richiesta. Tempi di consegna: 30gg
Available upon request only. Delivery terms: 30 days
Disponible seulement sur requête. Délais de livraison: 30 jours
Verfügbar auf Anfrage. Lieferzeit: 30 Tage

* DECORO realizzato con inserti in finitura 3D Satin
Decor made with inserts in 3D Satin finishing.
Décor composé d'inserts en finition 3D satinée.
Dekor mit Einsätzen im 3D-Satin-Finish hergestellt.

** DECORO realizzato con la serie Jungle Stone Wild Lap e Noble Stone.
Decor made with Jungle Stone Wild Lap and Noble Stone series.
Décor composé de Jungle Stone Wild Lap et Noble Stone séries.
Dekor mit der Serie Jungle Stone Wild Lap und Noble Stone ausgeführt.

*** DECORO realizzato con la serie Ca' Foscari e Noble Stone.
Decoration made with Ca' Foscari and Noble Stone series.
Décor composé de Ca' Foscari et Noble Stone séries.
Dekor mit der Serie Ca' Foscari und Noble Stone ausgeführt.

Bolgheri Stone

Bolgheri Stone

MARMO E PIETRA



SAGE



NATURAL



WHITE



BEIGE

V3
SHADE SPECTRUM
HIGH

ISO 13006 - G - Bla_E ≤ 0,5% - UNI EN 14411 - UGL

ANSI A - 326.3: 2021
WET DYNAMIC COEFFICIENT OF FRICTION

DCOF ≥ 0,42
naturale

100 % DESIGN AND
PRODUCTION OF ITALY

Bolgheri Stone
MARMO E PIETRA

6 mm



120x280
48"x110"
Lap Ret

8,8 mm R10B naturale



60x120
24"x48"
Nat Ret
Lap Ret
3D Satin Ret



60x60
24"x24"
Nat Ret

modular system

Decori / Decors

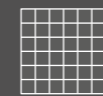

Mosaico 30x30
12"x12"
Nat Ret



Rombo 37x22
14 1/2"x8 1/2"
Nat Ret



Tex 30x26
12"x10 1/4"
Nat Ret

Sviluppo grafico per formato
Pattern by size
Développement graphique par format
Grafischer Entwurf für Format



120x280
6 mm

4

60x120
8,8 mm

11

60x60
8,8 mm

22

Sviluppo Grafico

Pattern by size. Développement graphique par format.
Grafischer Entwurf für Format

NATURAL 120x280 6mm



Decori

Decors

8,8mm R10B

SAGE



NATURAL



WHITE



BEIGE



Rombo 37x22 *
14 1/2"x8 1/2"
Nat Ret

Tex 30x26 *
12"x10 1/4"
Nat Ret

Mosaico 30x30
12"x12"
Nat Ret

* DECORO SAGE, NATURAL, BEIGE realizzato con inserti del colore White.
DECORO WHITE realizzato con inserti del colore Beige.
SAGE, NATURAL, BEIGE DECORATION made with White inserts.
WHITE DECORATION made with Beige inserts.

DÉCORATION SAGE, NATURAL, BEIGE faite d'inserts de la couleur White.
DÉCORATION WHITE faite d'inserts de la couleur Beige.
DEKOR SAGE, NATURAL, BEIGE mit Einlegern in der Farbe White.
DEKOR WHITE mit Einlegern in der Farbe Beige.

4 patterns

Bolgheri Stone

6 mm		8,8 mm			
120x280 48"x110"		60x120 24"x48"		60x60 24"x24"	
Lap Ret		Nat Ret		Nat Ret	
SAGE	196043	SAGE	196003	196013	196023
NATURAL	196044	NATURAL	196004	196014	196024
WHITE	196041	WHITE	196001	196011	196021
BEIGE	196042	BEIGE	196002	196012	196022
Price code	M175	Price code	M109	M125	M093

8,8 mm		8,8 mm					
60x120 24"x48"		Mosaico 30x30 12"x12"		Rombo* 37x22 14 1/2"x8 1/2"		Tex* 30x26 12"x10 1/4"	
3D Satin Ret		Nat Ret		Nat Ret		Nat Ret	
SAGE	196017	SAGE	196113	196103	196093		
NATURAL	196018	NATURAL	196114	196104	196094		
WHITE	196015	WHITE	196111	196101	196091		
BEIGE	196016	BEIGE	196112	196102	196092		
Price code	M129	Price code	M159	M215	M270		

Pezzi Speciali / Trims. Pièces speciale. Die Sonderstücke

8,8 mm		8,8 mm					
R 10 B naturale		Battiscopa Skirting		Gradino costa retta** Straight-edge stair		Gradino costa retta SX - DX** Straight-edge step L-R	
7x60		33x120		33x120			
Nat Ret		Lap Ret		Nat Ret		Lap Ret	
SAGE	196033	196123	196053	196143	196063 SX 196073 DX	196153 SX 196163 DX	
NATURAL	196034	196124	196054	196144	196064 SX 196074 DX	196154 SX 196164 DX	
WHITE	196031	196121	196051	196141	196061 SX 196071 DX	196151 SX 196161 DX	
BEIGE	196032	196122	196052	196142	196062 SX 196072 DX	196152 SX 196162 DX	
Price code	P021	P025	P207	P215	P231	P243	

* DECORO SAGE, NATURAL, BEIGE realizzato con inserti del colore White.
DECORO WHITE realizzato con inserti del colore Beige.
SAGE, NATURAL, BEIGE DECORATION made with White inserts.
WHITE DECORATION made with Beige inserts.

DÉCORATION SAGE, NATURAL, BEIGE faite d'inserts de la couleur White.
DÉCORATION WHITE faite d'inserts de la couleur Beige.
DEKOR SAGE, NATURAL, BEIGE mit Einlegern in der Farbe White.
DEKOR WHITE mit Einlegern in der Farbe Beige.



Wall
Bolgheri Stone Beige 120x280_48"x110" Lap Ret
Bolgheri Stone Tex Beige 30x26_12"x10 1/4" Nat Ret

Floor
Bolgheri Stone Beige 60x120_24"x48" Lap Ret

Imballi / Packings. Emballage. Verpackung

	PCS/BOX	MQ/BOX	KG/BOX	PCS/PAL	BOX/PAL	MQ/PAL	KG/PAL	PACKING	PACKING SIZE	TARE (KG)
6 mm										
120 x 280	-	-	-	20	-	67,20	974	CASSA	292 x 145 x 35h	108
	-	-	-	44	-	147,84	2205	CAVALLETTO LEGNO	290 x 75 x 161h	145
8,8 mm										
60 x 120 NAT RET	2	1,44	26,58	64	32	46,08	850	EPAL	80 x 120 x 75h	22
60 x 120 LAP RET	2	1,44	27,9	60	30	43,2	837	EPAL	80 x 120 x 75h	22
60 x 120 3D SATIN RET	2	1,44	28	64	32	46,08	896	EPAL	80 x 120 x 75h	22
60 x 60	3	1,08	20,3	120	40	43,2	811	EPAL	80 x 120 x 75h	22
DECORI. DECORS										
MOSAICO 30 x 30	6	0,54	10,36	360	60	32,40	622	EPAL	80 x 120	22
ROMBO 37 x 22*	6	0,49	9,75	360	60	29,40	585	EPAL	80 x 120	22
TEX 30 x 26 *	6	0,47	9,15	360	60	28,20	549	EPAL	80 x 120	22



Cavalletto in legno
Wood A-Frame.
Support en bois.
Holzgestell



Cassa
Crate . Caisse . Kiste



Epal

Pezzi Speciali / Trims	PCS/BOX	MQ/BOX	KG/BOX	PACKING	PACKING SIZE	TARE (KG)
8,8 mm						
BATTISCOPA 7 x 60	15	-	14,76	EPAL	80 x 120	22
GRADINO COSTA RETTA 33 x 120 x 3,2h **	2	-	23,00	EPAL	80 x 120	22
GRADINO COSTA RETTA 33 x 120 x 3,2h SX/DX **	1	-	12,00	EPAL	80 x 120	22

** A disposizione solo su richiesta.
Tempi di consegna: 30gg
Available upon request only.
Delivery terms: 30 days
Disponible seulement sur requête.
Délais de livraison: 30 jours
Verfügbar auf Anfrage.
Lieferzeit: 30 Tage.

Gemstone

MARMO E PIETRA

Mé
BISTROT

Gem
stone



OCEAN



NATURAL



DESERT



GREY

V3
SHADE SPECTRUM
HIGH

ISO 13006 - G - Bla_E ≤ 0,5% - UNI EN 14411 - UGL
ANSI A - 326.3: 2021
WET DYNAMIC COEFFICIENT OF FRICTION

100 % DESIGN AND
PRODUCTION OF ITALY

Gemstone
MARMO E PIETRA

6 mm



120x280
48"x110"
Lap Ret

8,8 mm R10B naturale



60x120
24"x48"
Nat Ret
Lap Ret



60x60
24"x24"
Nat Ret



30x60
12"x24"
Nat Ret

modular system

Decoro / Decor

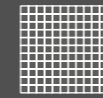

Mosaico 30x30
12"x12"
Nat Ret

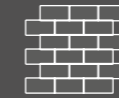

Muretto 30x30
12"x12"
Nat Ret



Octagone 30x28
12"x11"
Lap Ret



Rombo 31x31
12 1/4"x12 1/4"
Lap Ret

Sviluppo grafico per formato
Pattern by size
Développement graphique par format
Grafischer Entwurf für Format



	120x280 6 mm	60x120 8,8 mm	60x60 8,8 mm	30x60 8,8 mm
NATURAL	3	13	26	52
OCEAN DESERT GREY	3	12	24	48

Sviluppo Grafico

Pattern by size. Développement graphique par format.
Grafischer Entwurf für Format

OCEAN 120x280 6 mm

3 patterns

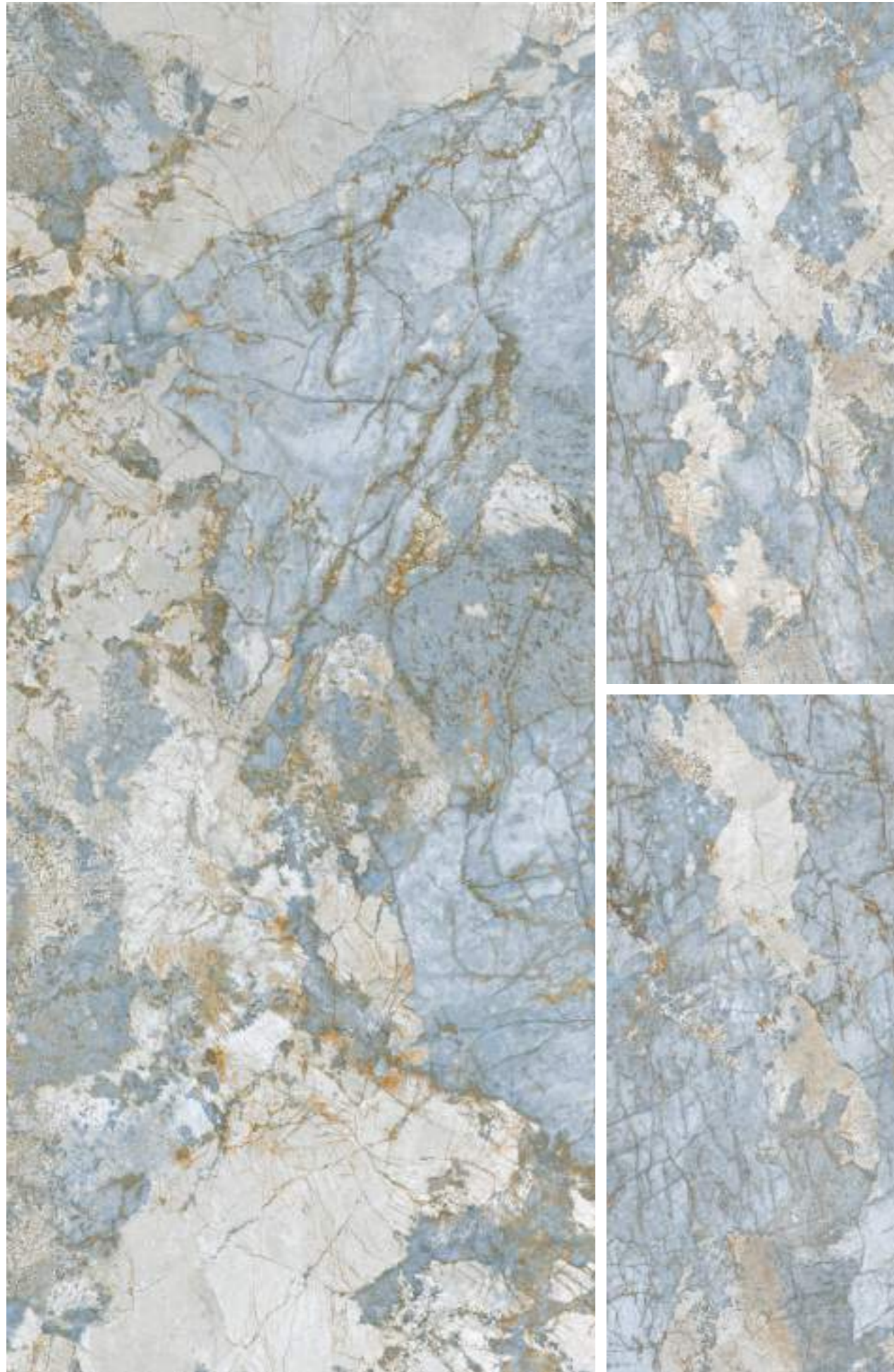

Decori

Decors

8,8 mm R10B naturale

OCEAN

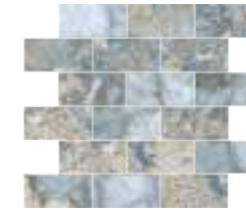

NATURAL



DESERT

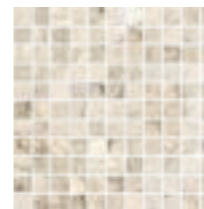

GREY



Mosaico 30x30
12"x12"
Nat Ret

Muretto 30x30
12"x12"
Nat Ret

Octagone 30x28
12"x11"
Lap Ret

Rombo 31x31
12¼"x12¼"
Lap Ret



Wall
Muretto Grey 30x30_12"x12" Nat Ret

Floor
Natural 60x120_24"x48" Lap Ret

Furniture
Natural 60x120_24"x48" Nat Ret

Gemstone

6 mm		8,8 mm				
R 1 0 B naturale		R 1 0 B naturale				
120x280 48"x110"		60x120 24"x48"		60x60 24"x24"	30x60 12"x24"	
Lap Ret		Nat Ret	Lap Ret	Nat Ret	Nat Ret	
OCEAN	179161	OCEAN	179031	179071	179001	179011
NATURAL	179162	NATURAL	179032	179072	179002	179012
DESERT	179163	DESERT	179033	179073	179003	179013
GREY	179165	GREY	179035	179075	179005	179015
Price code	M175	Price code	M109	M125	M093	M085

8,8 mm		8,8 mm			
R 1 0 B naturale		R 1 0 B naturale			
Mosaico 30x30 12"x12"		Muretto 30x30 12"x12"	Octagone 30x28 12"x11"	Rombo 31x31 12 1/4"x12 1/4"	
Nat Ret		Nat Ret	Lap Ret	Lap Ret	
OCEAN	179121	179131	179141	179151	
NATURAL	179122	179132	179142	179152	
DESERT	179123	179133	179143	179153	
GREY	179125	179135	179145	179155	
Price code	M193	M181	M324	M235	

Pezzi Speciali / Trims. Pièces speciale. Die Sonderstücke

8,8 mm		8,8 mm		8,8 mm		
R 1 0 B naturale		R 1 0 B naturale		R 1 0 B naturale		
Battiscopa Skirting 7x60		Gradino costa retta** Straight-edge stair** 33x120		Gradino costa retta SX - DX** Straight-edge step L-R 33x120		
Nat Ret		Nat Ret		Nat Ret		
OCEAN	179171	179181	179201	179211	179301 SX 179321 DX	179311 SX 179331 DX
NATURAL	179172	179182	179202	179212	179302 SX 179322 DX	179312 SX 179332 DX
DESERT	179173	179183	179203	179213	179303 SX 179323 DX	179313 SX 179333 DX
GREY	179175	179185	179205	179215	179305 SX 179325 DX	179315 SX 179335 DX
Price code	P021	P025	P207	P215	P231	P243



Wall
Desert 30x60_12"x24" Nat Ret
Rombo Desert 31x31_12 1/4"x12 1/4" Lap Ret

Floor
Natural 60x120_24"x48" Lap Ret

Imballi / Packings. Emballage. Verpackung

	PCS/BOX	MQ/BOX	KG/BOX	PCS/PAL	BOX/PAL	MQ/PAL	KG/PAL	PACKING	PACKING SIZE
6 mm									
120 x 280	-	-	-	20	-	67,20	1081	CASSA	292 x 145 x 35h
	-	-	-	44	-	147,84	2350	CAVALLETTO LEGNO	290 x 75 x 161h
8,8 mm									
60 x 120 Nat	2	1,44	27,9	-	32	46,08	913	EPAL	80 x 120 x 75h
60 x 120 Lap	2	1,44	28,09	-	32	46,08	919	EPAL	80 x 120 x 75h
60 x 60	3	1,08	25,54	-	40	43,20	1.042	EPAL	80 x 120 x 75h
30 x 60	7	1,26	24,00	-	48	60,48	1.172	EPAL	80 x 120 x 75h
DECORI. DECORS									
MOSAICO 30 x 30	6	0,54	12,99	-	54	29,16	702	EPAL	80 x 120
MURETTO 30 x 30	6	0,63	12,90	-	54	34,02	696	EPAL	80 x 120
OCTAGONE 30 x 28	6	0,50	10,50	-	54	27	567	EPAL	80 x 120
ROMBO 31 x 31	6	0,58	11,20	-	54	31,32	605	EPAL	80 x 120

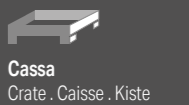

PEZZI SPECIALI. TRIMS	PCS/BOX	MQ/BOX	KG/BOX	PACKING	PACKING SIZE
8,8 mm					
BATTISCOPA 7 x 60	15	0,63	13,28	EPAL	80 x 120
GRADINO COSTA RETTA 33 x 120 x 3,2h **	2	-	20,70	EPAL	80 x 120
GRADINO COSTA RETTA 33 x 120 x 3,2h SX/DX **	1	-	10,80	EPAL	80 x 120

** A disposizione solo su richiesta.
Tempi di consegna: 30gg
Available upon request only.
Delivery terms: 30 days
Disponible seulement sur requête.
Délais de livraison: 30 jours
Verfügbar auf Anfrage.
Lieferzeit: 30 Tage.

Copa cabana Empe ror



Copacabana Emperor

MARMO E PIETRA



ISO 13006 - G - Bla_E ≤ 0,5% - UNI EN 14411 - UGL
 ANSI A - 326.3: 2021
 WET DYNAMIC COEFFICIENT OF FRICTION



Copacabana Emperor

MARMO E PIETRA

6 mm



160x320
 63"x126"
 Nat Ret
 Lap Ret



120x240
 48"x96"
 Nat Ret
 Lap Ret



120x120
 48"x48"
 Nat Ret
 Lap Ret

modular system

Decoro / Decor



Mosaico 30x30
 12"x12"
 Nat Ret
 Lap Ret

8,8 mm



60x120
 24"x48"
 Nat Ret
 Lap Ret

Sviluppo grafico per formato
 Pattern by size
 Développement graphique par format
 Grafischer Entwurf für Format



160x320
 6 mm

7

120x240
 6 mm

11

120x120
 6 mm

22

60x120
 8,8 mm

28

Sviluppo Grafico

Pattern by size. Développement graphique par format.
Grafischer Entwurf für Format

160x320 6 mm



Copacabana Emperor

MARMO E PIETRA

6 mm	160x320 63"x126"		120x240 48"x96"		120x120 48"x48"		Mosaico 30x30 12"x12"		8,8 mm	60x120 24"x48"	
	Nat Ret	Lap Ret	Nat Ret	Lap Ret	Nat Ret	Lap Ret	Nat Ret	Lap Ret		Nat Ret	Lap Ret
	081010	081009	081030	081029	081060	081059	081179	081180		081130	081129
Price code	M173	M197	M153	M175	M141	M169	M193	M235		M109	M125

Pezzi Speciali / Trims. Pièces speciale. Die Sonderstücke

6 mm	33x120		33x120		8,8 mm	6,5x120		33x120		33x120	
	Nat Ret	Lap Ret	Nat Ret	Lap Ret		Nat Ret	Lap Ret	Nat Ret	Lap Ret	Nat Ret	Lap Ret
	081280	081279	081370 SX	081369 SX		081210	081209	081290	081289	081380 SX	081379 SX
			081320 DX	081319 DX						081330 DX	081329 DX
Price code	P243	P265	P273	P283		P040	P043	P207	P215	P231	P243

Imballi / Packings. Emballage. Verpackung

	PCS/BOX	MQ/BOX	KG/BOX	PCS/PAL	BOX/PAL	MQ/PAL	KG/PAL	PACKING	PACKING SIZE	TARE (KG)
6 mm										
160 x 320	-	-	-	14	-	71,68	1.178	CASSA	345 x 175 x 37h	140
	-	-	-	44	-	225,28	3.439	CAVALLETTO LEGNO	330 x 75 x 193,5h	177,50
120 x 240	-	-	-	20	-	57,60	934	CASSA	264 x 136 x 40h	100
	-	-	-	44	-	126,72	1.967	CAVALLETTO LEGNO	250 x 75 x 161h	132
120 x 120	2	2,88	41,70	-	24	69,12	1.041	PALLET SPECIALE	123x 143 x 74h	29
MOSAICO 30 x 30	9	0,81	11,90	-	60	48,60	716	EPAL	80 x 120	22
8,8 mm										
60 x 120 Nat	2	1,44	27,9	-	30	43,20	839	EPAL	80 x 120	22
60 x 120 Lap	2	1,44	27,9	-	30	43,20	839	EPAL	80 x 120	22



Cavalletto in legno
Wood A-Frame. Support en bois.
Holzgestell



Cassa
Crate. Caisse. Kiste



Pallet speciale con sponde
Special pallet with sides.
Palette spéciale avec bords.
Spezial-Palette mit Wandungen.



Epal / Pallet

PEZZI SPECIALI. TRIMS.	PCS/BOX	MQ/BOX	KG/BOX	PACKING	PACKING SIZE
6 mm					
GRADINO COSTA RETTA 33 x 120 x 3,2h *	2	-	14	PALLET	80 x 120
GRADINO COSTA RETTA 33 x 120 x 3,2h SX/DX **	1	-	7	PALLET	80 x 120
8,8 mm					
BATTISCOPA 6,5 x 120	6	-	11,40	PALLET	80 x 120
GRADINO COSTA RETTA 33 x 120 x 3,2h **	2	-	22	PALLET	80 x 120
GRADINO COSTA RETTA 33 x 120 x 3,2h SX/DX **	1	-	11	PALLET	80 x 120

**** A disposizione solo su richiesta.**
Tempi di consegna: 30gg
Available upon request only.
Delivery terms: 30 days
Disponible seulement sur requête.
Délais de livraison: 30 jours
Verfügbar auf Anfrage.
Lieferzeit: 30 Tage.

7 patterns

Sahara Noir

Sahara Noir

MARMO E PIETRA



V2
SHADE SPECTRUM
MODERATE

ISO 13006 - G - Bla_E ≤ 0,5% - UNI EN 14411 - UGL

100 % DESIGN AND
PRODUCTION OF ITALY

Sahara Noir
MARMO E PIETRA

6 mm



120x280
48"x110"
Lap Ret

8,8 mm



80x180
31½"x71"
Lap Ret



60x120
24"x48"
Lap Ret

Sviluppo grafico per formato
Pattern by size
Développement graphique par format
Grafischer Entwurf für Format



120x280
6 mm

4

80x180
8,8 mm

11

60x120
8,8 mm

13

Sviluppo Grafico

Pattern by size. Développement graphique par format.
Grafischer Entwurf für Format.

120x280 6 mm

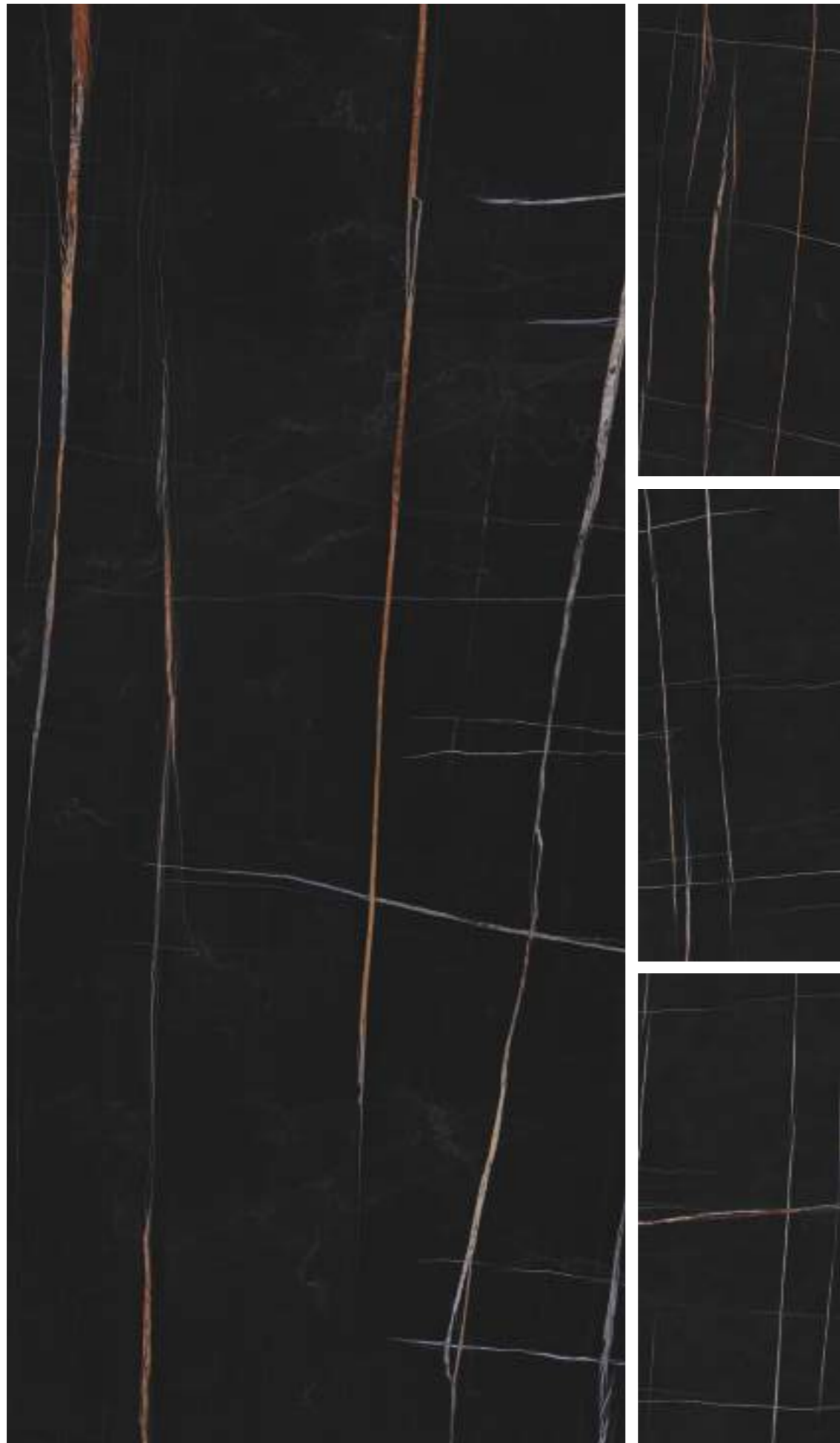

6 mm	120x280 48"x110"	8,8 mm	80x180 31 1/2"x71"	60x120 24"x48"
	Lap Ret		Lap Ret	Lap Ret
	185004		135051	135061
Price code	M181		M151	M133

Pezzi Speciali / Trims. Pièces speciale. Die Sonderstücke

8,8 mm	Battiscopa Skirting	Gradino costa retta** Straight-edge stair**	Gradino costa retta SX - DX** Straight-edge step L-R
	6,5x120	33x120	33x120
	Lap Ret	Lap Ret	Lap Ret
	135201	135331	135333 SX 135332 DX
Price code	P043	P215	P243

Imballi / Packings. Emballage. Verpackung

	PCS/BOX	MQ/BOX	KG/BOX	PCS/PAL	BOX/PAL	MQ/PAL	KG/PAL	PACKING	PACKING SIZE
6 mm									
120 x 280	-	-	-	20	-	67,20	1.189	CASSA	292 x 145 x 35h
	-	-	-	44	-	147,84	2.205	CAVALLETTO LEGNO	290 x 75 x 161h
8,8 mm									
80 x 180	2	2,88	64,89	-	20	57,60	1.343	PALLET CON SPONDE	97 x 188 x 95h
60 x 120	2	1,44	27,9	-	30	43,20	837	EPAL	80 x 120 x 75h

PEZZI SPECIALI. TRIMS	PCS/BOX	MQ/BOX	KG/BOX	PACKING	PACKING SIZE
8,8 mm					
BATTISCOPA 6,5 x 120	6	-	11	EPAL	80 x 120
GRADINO COSTA RETTA 33 x 120 x 3,2h **	2	-	23	EPAL	80 x 120
GRADINO COSTA RETTA 33 x 120 x 3,2h SX/DX **	1	-	12	EPAL	80 x 120

** A disposizione solo su richiesta.
Tempi di consegna: 30gg
Available upon request only.
Delivery terms: 30 days
Disponible seulement sur requête.
Délais de livraison: 30 jours
Verfügbar auf Anfrage.
Lieferzeit: 30 Tage.



Cavalletto in legno
Wood A-Frame. Support en bois.
Holzgestell



Cassa
Crate . Caisse . Kiste



Pallet speciale con sponde
Special pallet with sides.
Palette spéciale avec bords.
Spezial-Palette mit Wandungen.



Epal

4 patterns



Castle

MARMO E PIETRA

Ca
stle



WINDSOR



PRAGUE



CHAMBORD



BALMORAL

V4
SHADE SPECTRUM
RANDOM

ISO 13006 - G - Bla_E ≤ 0.5% - UNI EN 14411 - GL

100 % DESIGN AND
PRODUCTION OF ITALY

Castle
MARMO E PIETRA

8,8 mm



60x120
24"x48"
Lap Ret



20x120
8"x48"
Lap Ret

modular system

Decoro / Decor



Mosaico 30x30
12"x12"
Lap Ret

Sviluppo grafico per formato
Pattern by size
Développement graphique par format
Grafischer Entwurf für Format



60x120
8,8 mm

18

20x120
8,8 mm

54

BALMORAL 60x120 8,8 mm

18 patterns



	60x120 24"x48"		20x120 8"x48"		Mosaico 30x30 12"x12"	
	Lap Ret		Lap Ret		Lap Ret	
WINDSOR	110009	110030			110080	
PRAGUE	110007	110028			110077	
CHAMBORD	110005	110026			110074	
BALMORAL	110001	110022			110071	
Price code	M125	M129			M187	

Pezzi Speciali / Trims. Pièces speciale. Die Sonderstücke

	Battiscopa Skirting 6,5x120		Gradino costa retta** Straight-edge stair** 33x120		Gradino costa retta SX - DX** Straight-edge step L-R 33x120	
	Lap Ret		Lap Ret		Lap Ret	
WINDSOR	110100	110153	110160 SX 110156 DX			
PRAGUE	110097	110152	110159 SX 110155 DX			
CHAMBORD	110094	110151	110158 SX 110154 DX			
BALMORAL	110091	110150	110157 SX 110161 DX			
Price code	P043	P215	P243			

Imballi / Packings. Emballage. Verpackung

	PCS/BOX	MQ/BOX	KG/BOX	BOX/PAL	MQ/PAL	KG/PAL	PACKING	PACKING SIZE
8,8 mm								
60 x 120	2	1,44	32,30	30	43,20	989	EPAL	80 x 120 x 75h
20 x 120	6	1,44	31,82	24	34,56	783	EPAL	80 x 120 x 55h
DECORI. DECORS								
MOSAICO 30 x 30	6	0,54	12,69	54	29,16	705	EPAL	80 x 120 x 73h

	PCS/BOX	MQ/BOX	KG/BOX	BOX/PAL	MQ/PAL	KG/PAL	PACKING	PACKING SIZE
PEZZI SPECIALI. TRIMS								
8,8 mm								
BATTISCOPA 6,5 x 120	6	0,47	10,55	45	21,15	495	EPAL	80 x 120
GRADINO COSTA RETTA 33 x 120 x 3,2h **	2	-	20	-	-	-	EPAL	80 x 120
GRADINO COSTA RETTA 33 x 120 x 3,2h SX/DX **	1	-	11	-	-	-	EPAL	80 x 120



** A disposizione solo su richiesta.
Tempi di consegna: 30gg
Available upon request only.
Delivery terms: 30 days
Disponible seulement sur requête.
Délais de livraison: 30 jours
Verfügbar auf Anfrage.
Lieferzeit: 30 Tage.

Imperial



Imperial

MARMO E PIETRA

ALABASTRINO

TREVI

NAVONA

TIVOLI

V2
SHADE SPECTRUM
MODERATE

ANSI A - 326.3: 2021
WET DYNAMIC COEFFICIENT OF FRICTION | DCOF ≥ 0,42
ISO 13006 - G - Bla_E ≤ 0,5% - UNI EN 14411 - GL

100 % DESIGN AND
PRODUCTION OF ITALY

Imperial
MARMO E PIETRA

8,8 mm R10B naturale



120x120
48"x48"
Nat Ret
Lap Ret



60x120
24"x48"
Nat Ret
Lap Ret



60x60
24"x24"
Nat Ret
Lap Ret



30x60
12"x24"
Nat Ret
Lap Ret



10x30
4"x12"
Nat Ret
Lap Ret

modular system

Decor / Decors



Mosaico 30x30
12"x12"
Nat Ret



Esagona 28x29
11"x11 1/2"
Nat Ret



Muretto 30x30
12"x12"
Nat Ret



Intreccio 30x30
12"x12"
Nat Ret



Spina di pesce 30,5x30,5
12"x12"
Nat Ret

Sviluppo grafico per formato
Pattern by size
Développement graphique par format
Grafischer Entwurf für Format



120x120
8,8 mm
10

60x120
8,8 mm
15

60x60
8,8 mm
30

30x60
8,8 mm
53

10x30
8,8 mm
318

Sviluppo Grafico

Pattern by size. Développement graphique par format. Grafischer Entwurf für Format

ALABASTRINO 60x120 8,8 mm

15 patterns



Decorì

Decors

8,8 mm R10B

ALABASTRINO

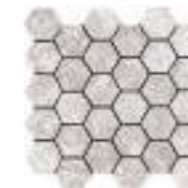
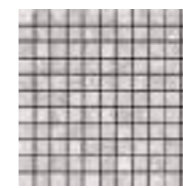

TREVI



NAVONA



TIVOLI

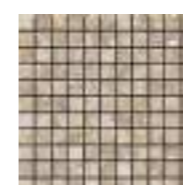

Mosaico 30x30
12"x12"
Nat Ret

Esagona 28x29
11"x11 1/2"
Nat Ret

Muretto 30x30
12"x12"
Nat Ret

Spina di pesce 30,5x30,5
12"x12"
Nat Ret

Intreccio 30x30
12"x12"
Nat Ret

Imperial

8,8 mm
R10B
naturale

	120x120 48"x48"		60x120 24"x48"		60x60 24"x24"		30x60 12"x24"		10x30 4"x12"	
	Nat Ret	Lap Ret	Nat Ret	Lap Ret	Nat Ret	Lap Ret	Nat Ret	Lap Ret	Nat Ret	Lap Ret
ALABASTRINO	155041	155045	155001	155005	155011	155015	155021	155025	155031	155035
TREVI	155042	155046	155002	155006	155012	155016	155022	155026	155032	155036
NAVONA	155043	155047	155003	155007	155013	155017	155023	155027	155033	155037
TIVOLI	155044	155048	155004	155008	155014	155018	155024	155028	155034	155038
Price code	M121	M131	M109	M121	M093	M117	M085	M117	M123	M139

8,8 mm
R10B

	Mosaico 30x30 12"x12"	Esagona 28x29 11"x11 1/2"	Muretto 30x30 12"x12"	Intreccio 30x30 12"x12"	Spina di pesce 30,5x30,5 12"x12"
	Nat Ret	Nat Ret	Nat Ret	Nat Ret	Nat Ret
ALABASTRINO	155331	155321	155341	155311	155301
TREVI	155332	155322	155342	155312	155302
NAVONA	155333	155323	155343	-	155303
TIVOLI	155334	155324	155344	155314	155304
Price code	M193	M303	M215	M211	M199



Wall
Navona 60x120_24"x48" Nat Ret
Decoro Esagona Navona 28x29_11"x11 1/2" Nat Ret

Floor
Navona 60x120_24"x48" - 60x60_24"x24" Nat Ret

Pezzi Speciali / Trims. Pièces speciale. Die Sonderstücke

8,8 mm
R10B
naturale

	Battiscopa Skirting	Gradino costa retta** Straight-edge stair**	Gradino costa retta SX - DX** Straight-edge step L-R		
	7x60	33x120	33x120		
	Nat Ret	Nat Ret	Lap Ret	Nat Ret	Lap Ret
ALABASTRINO	155111	155201	155205	155221 SX 155211 DX	155225 SX 155215 DX
TREVI	155112	155202	155206	155222 SX 155212 DX	155226 SX 155216 DX
NAVONA	155113	155203	155207	155223 SX 155213 DX	155227 SX 155217 DX
TIVOLI	155114	155204	155208	155224 SX 155214 DX	155228 SX 155218 DX
Price code	P021	P207	P215	P231	P243

Imballi / Packings. Emballage. Verpackung

	PCS/BOX	MQ/BOX	KG/BOX	BOX/PAL	MQ/PAL	KG/PAL	PACKING	PACKING SIZE
8,8 mm								
120 x 120	1	1,44	28,50	40	57,60	1.169	PALLET	123x 143 x 74h
60 x 120 Nat	2	1,44	33,12	32	46,08	1.079	EPAL	80 x 120 x 75h
60 x 120 Lap	2	1,44	33,54	30	43,20	996	EPAL	80 x 120 x 75h
60 x 60	3	1,08	22,84	40	43,20	934	EPAL	80 x 120 x 75h
30 x 60	7	1,26	24	48	60,48	1.172	EPAL	80 x 120 x 75h
10 x 30	19	0,57	11,43	72	41,04	843	EPAL	80 x 120 x 81h
DECORI. DECORS								
MOSAICO 30 x 30	6	0,54	10,36	60	32,40	641,60	EPAL	80 x 120
ESAGONA 28 x 29	6	0,48	9,41	60	28,80	584,60	EPAL	80 x 120
MURETTO 30 x 30	6	0,54	10,36	60	32,40	641,60	EPAL	80 x 120
INTRECCIO 30 x 30	6	0,54	10,36	60	32,40	641,60	EPAL	80 x 120
SPINA DI PESCE 30,5x30,5	6	0,55	10,74	60	33,00	664,40	EPAL	80 x 120



PEZZI SPECIALI. TRIMS	PCS/BOX	MQ/BOX	KG/BOX	PACKING	PACKING SIZE
8,8 mm					
BATTISCOPA 7 x 60	15	0,63	13,28	EPAL	80 x 120
GRADINO COSTA RETTA 33 x 120 x 3,2h **	2	-	20,70	EPAL	80 x 120
GRADINO COSTA RETTA 33 x 120 x 3,2h SX/DX **	1	-	10,80	EPAL	80 x 120

**A disposizione solo su richiesta. Tempi di consegna: 30gg.
Available upon request only. Delivery terms: 30 days.
Disponible seulement sur requête. Délais de livraison: 30 jours.
Verfügbar auf Anfrage. Lieferzeit: 30 Tage.

Jungle Stone

Jungle Stone
MARMO E PIETRA

SILVER

GRAVEL

BONE

DESERT

WILD

V3
SHADE SPECTRUM
HIGH

ISO 13006 - G - Bla_E ≤ 0,5% - UNI EN 14411 - GL
ANSI A - 326.3: 2021
WET DYNAMIC COEFFICIENT OF FRICTION

100 % DESIGN AND
PRODUCTION OF ITALY

Jungle Stone

MARMO E PIETRA

8,8 mm R10B naturale



120x120
48"x48"
Nat Ret
Lap Ret



60x120
24"x48"
Nat Ret
Lap Ret



60x60
24"x24"
Nat Ret
Lap Ret



30x60
12"x24"
Nat Ret
Lap Ret



10x30
4"x12"
Nat Ret
Lap Ret

modular system

Decori / Decors



Esagona 28x29
11"x11 1/2"
Nat Ret

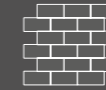

Muretto 30x30
12"x12"
Nat Ret

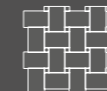

Intreccio 30x30
12"x12"
Nat Ret



Spina di pesce 33,5x30
13"x12"
Nat Ret

Sviluppo grafico per formato
Pattern by size
Développement graphique par format
Grafischer Entwurf für Format



120x120
8,8 mm

7

60x120
8,8 mm

17

60x60
8,8 mm

24

30x60
8,8 mm

68

10x30
8,8 mm

408

Sviluppo Grafico

Pattern by size. Développement graphique par format. Grafischer Entwurf für Format

Jungle Stone
MARMO E PIETRA

DESERT 60x120 8,8 mm

17 patterns



Decori

Decors

8,8 mm R10B

SILVER

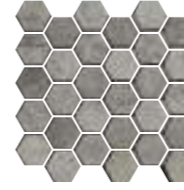

GRAVEL



BONE



DESERT



WILD

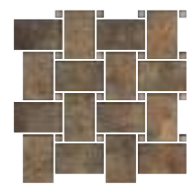

Esagona 28x29
11"x11 1/2"
Nat Ret

Muretto 30x30
12"x12"
Nat Ret

Spina di pesce 33,5x30
13"x12"
Nat Ret

Intreccio 30x30
12"x12"
Nat Ret

Jungle Stone

8,8 mm

R 10 B
naturale

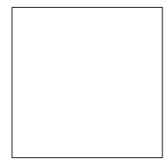

	120x120 48"x48"		60x120 24"x48"		60x60 24"x24"		30x60 12"x24"		10x30 4"x12"	
	Nat Ret	Lap Ret	Nat Ret	Lap Ret	Nat Ret	Lap Ret	Nat Ret	Lap Ret	Nat Ret	Lap Ret
SILVER	154041	154046	154001	154006	154011	154016	154021	154026	154031	154036
GRAVEL	154042	154047	154002	154007	154012	154017	154022	154027	154032	154037
BONE	154043	154048	154003	154008	154013	154018	154023	154028	154033	154038
DESERT	154044	154049	154004	154009	154014	154019	154024	154029	154034	154039
WILD	154045	154050	154005	154010	154015	154020	154025	154030	154035	154040
Price code	M121	M131	M109	M121	M093	M117	M085	M117	M123	M139

8,8 mm

R 10 B



	Esagona 28x29 11"x11 1/2"	Muretto 30x30 12"x12"	Intreccio 30x30 12"x12"	Spina di pesce 33,5x30,5 13"x12"
	Nat Ret	Nat Ret	Nat Ret	Nat Ret
SILVER	154311	154316	154306	154301
GRAVEL	154312	154317	-	154302
BONE	154313	154318	154308	154303
DESERT	154314	154319	-	154304
WILD	154315	154320	154310	154305
Price code	M303	M167	M197	M189

Pezzi Speciali / Trims. Pièces speciale. Die Sonderstücke

8,8 mm

R 10 B
naturale

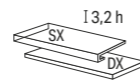

	Battiscopa Skirting	Gradino costa retta** Straight-edge stair**		Gradino costa retta SX - DX** Straight-edge step L-R	
	7x60	33x120		33x120	
	Nat Ret	Nat Ret	Lap Ret	Nat Ret	Lap Ret
SILVER	154101	154201	154206	154221 SX 154211 DX	154226 SX 154216 DX
GRAVEL	154102	154202	154207	154222 SX 154212 DX	154227 SX 154217 DX
BONE	154103	154203	154208	154223 SX 154213 DX	154228 SX 154218 DX
DESERT	154104	154204	154209	154224 SX 154214 DX	154229 SX 154219 DX
WILD	154105	154205	154210	154225 SX 154215 DX	154230 SX 154220 DX
Price code	P021	P207	P215	P231	P243



Floor
Silver 60x120_24"x48" - 60x60_24"x24" Nat Ret

Imballi / Packings. Emballage. Verpackung

	PCS/BOX	MQ/BOX	KG/BOX	BOX/PAL	MQ/PAL	KG/PAL	PACKING	PACKING SIZE
8,8 mm								
120 x 120	1	1,44	28,50	40	57,60	1.169	PALLET	123x 143 x 74h
60 x 120	2	1,44	29,82	32	46,08	974	EPAL	80 x 120 x 75h
60 x 60	3	1,08	22,84	40	43,20	934	EPAL	80 x 120 x 75h
30 x 60	7	1,26	24	48	60,48	1.172	EPAL	80 x 120 x 75h
10 x 30	19	0,57	11,43	72	41,04	843	EPAL	80 x 120 x 81h
DECORI. DECORS								
ESAGONA 28 x 29	6	0,48	9,41	60	28,80	584,60	EPAL	80 x 120
MURETTO 30 x 30	6	0,54	10,36	60	32,40	641,60	EPAL	80 x 120
INTRECCIO 30 x 30	6	0,54	10,36	60	32,40	641,60	EPAL	80 x 120
SPINA DI PESCE 33,5 x 30,5	6	0,60	11,71	60	36,00	722,60	EPAL	80 x 120



PEZZI SPECIALI. TRIMS	PCS/BOX	MQ/BOX	KG/BOX	PACKING	PACKING SIZE
8,8 mm					
BATTISCOPA 7 x 60	15	0,63	13,28	EPAL	80 x 120
GRADINO COSTA RETTA 33 x 120 x 3,2h **	2	-	20,70	EPAL	80 x 120
GRADINO COSTA RETTA 33 x 120 x 3,2h SX/DX **	1	-	10,80	EPAL	80 x 120

**A disposizione solo su richiesta. Tempi di consegna: 30gg.
Available upon request only. Delivery terms: 30 days.
Disponible seulement sur requête. Délais de livraison: 30 jours.
Verfügbar auf Anfrage. Lieferzeit: 30 Tage.



High Line

High Line

MARMO E PIETRA

ESSEX

CHELSEA

BROADWAY

LIBERTY

MADISON

V4
SHADE SPECTRUM
RANDOM

ISO 13006 - G - Bla_E ≤ 0,5% - UNI EN 14411 - GL
ANSI A - 326.3: 2021
WET DYNAMIC COEFFICIENT OF FRICTION

DCOF ≥ 0,42
naturale
100 % DESIGN AND
PRODUCTION OF ITALY

High Line
MARMO E PIETRA

8,8 mm R10B naturale



60x120
24"x48"
Nat Ret
Lap Ret



20x120
8"x48"
Nat Ret
Lap Ret



60x60
24"x24"
Nat Ret
Lap Ret



30x60
12"x24"
Nat Ret



10x30
4"x12"
Nat Ret

modular system

Decori / Decors



Mosaico 30x30
12"x12"
Nat Ret
Lap Ret

8,8 mm OUTDOOR R11C



Essex
Broadway
Madison

30,5x60,5
12"x24"
Nat

Sviluppo grafico per formato
Pattern by size
Développement graphique par format
Grafischer Entwurf für Format



60x120
8,8 mm
19

20x120
8,8 mm
57

60x60
8,8 mm
45

30x60
8,8 mm
63

10x30
8,8 mm
378

30,5x60,5
8,8 mm R11
63

Sviluppo Grafico

Pattern by size. Développement graphique par format. Grafischer Entwurf für Format

ESSEX 60x120 8,8 mm

19 patterns



Floor
Essex 30x60_12"x24" Nat Ret

High Line

8,8 mm
R10B
Naturale

	60x120 24"x48"		20x120 8"x48"		60x60 24"x24"		30x60 12"x24"	10x30 4"x12"	Mosaico 30x30 12"x12"	
	Nat Ret	Lap Ret	Nat Ret	Lap Ret	Nat Ret	Lap Ret	Nat Ret	Nat Ret	Nat Ret	Lap Ret
ESSEX	109006	109007	109026	109027	109046	109047	109066	109144	109086	109087
CHELSEA	109003	109004	109023	109024	109043	109044	109063	109142	109083	109084
BROADWAY	109001	109002	109021	109022	109041	109042	109061	109140	109081	109082
LIBERTY	109009	109010	109029	109030	109049	109050	109069	109146	109089	109090
MADISON	109012	109013	109032	109033	109052	109053	109072	109148	109092	109093
Price code	M109	M125	M113	M129	M089	M113	M089	M123	M159	M187

8,8 mm
R11C

	30,5x60,5 12"x24"
	Nat
ESSEX	109065
BROADWAY	109060
MADISON	109071
Price code	M073



Wall
Chelsea 30x60_12"x24" Nat Ret
Mosaico Chelsea 30x30_12"x12" Lap Ret
Floor
Chelsea 60x120_24"x48" Nat Ret

Pezzi Speciali / Trims. Pièces speciale. Die Sonderstücke

8,8 mm
R10B
Naturale

	6,5x120		9,5x60		33x120		33x60		33x120		33x60	
	Nat Ret	Lap Ret	Nat Ret	Lap Ret	Nat Ret	Lap Ret	Nat Ret	Lap Ret	Nat Ret	Lap Ret	Nat Ret	Lap Ret
ESSEX	109126	109124	109136	109135	109210	109204	109237	109240	109223 SX 109218 DX	109232 SX 109227 DX	109249 SX 109245 DX	109258 SX 109253 DX
CHELSEA	109123	109122	109134	109133	109209	109213	109236	109239	109222 SX 109217 DX	109231 SX 109226 DX	109248 SX 109244 DX	109257 SX 109252 DX
BROADWAY	109121	109120	109132	109131	109208	109212	109235	109238	109221 SX 109216 DX	109230 SX 109225 DX	109247 SX 109243 DX	109256 SX 109251 DX
LIBERTY	109128	109127	109138	109137	109211	109214	109205	109241	109224 SX 109219 DX	109233 SX 109228 DX	109250 SX 109246 DX	109259 SX 109254 DX
MADISON	109130	109129	109150	109151	109201	109215	109202	109242	109206 SX 109220 DX	109234 SX 109229 DX	109207 SX 109203 DX	109260 SX 109255 DX
Price code	P040	P043	P021	P025	P207	P215	P141	P143	P231	P231	P169	P169

Imballi / Packings. Emballage. Verpackung

	PCS/BOX	MQ/BOX	KG/BOX	BOX/PAL	MQ/PAL	KG/PAL	PACKING	PACKING SIZE
8,8 mm								
60 x 120	2	1,44	27,9	30	43,20	892,8	EPAL	80 x 120 x 75h
20 x 120	6	1,44	27,9	24	34,56	669,60	EPAL	80 x 120 x 55h
60 x 60	3	1,08	21	40	43,2	840	EPAL	80 x 120 x 75h
30 x 60	6	1,08	24	48	60,48	1.152	EPAL	80 x 120 x 75h
10 x 30	19	0,57	12,69	72	41,04	914,32	EPAL	80 x 120 x 81h
30,5 x 60,5 R11	7	1,29	24,6	40	51,60	984	EPAL	80 x 120 x 76h
DECORI. DECORS								
MOSAICO 30x30	6	0,54	12,15	54	29,16	656	EPAL	80 x 120 x 75h



PEZZI SPECIALI. TRIMS	PCS/BOX	MQ/BOX	KG/BOX	PACKING	PACKING SIZE
8,8 mm					
BATTISCOPA 6,5x120	6	0,46	11	EPAL	80x120
BATTISCOPA 9,5x60	12	0,68	14,52	EPAL	80x120
GRADINO COSTA RETTA 33x120x3,2h **	2	-	23	EPAL	80x120
GRADINO COSTA RETTA 33x120x3,2h SX/DX **	1	-	12	EPAL	80x120
GRADINO COSTA RETTA 33x60x3,2h **	4	-	20	EPAL	80x120
GRADINO COSTA RETTA 33x60x3,2h SX/DX **	2	-	11	EPAL	80x120

** A disposizione solo su richiesta. Tempi di consegna: 30gg
Available upon request only. Delivery terms: 30 days
Disponible seulement sur requête. Délais de livraison: 30 jours
Verfügbar auf Anfrage. Lieferzeit: 30 Tage



*Pier
res
des Châ
teaux*

Pierres des Châteaux

MARMO E PIETRA

CHENONCEAU

CHAMBORD

CHEVERNY

USSÉ

FONTAINEBLEAU

V3
SHADE SPECTRUM
HIGH

ISO 13006 - G - Bla_E ≤ 0,5% - UNI EN 14411 - UGL
ANSI A - 326.3: 2021
WET DYNAMIC COEFFICIENT OF FRICTION | DCOF ≥ 0,42

100 % DESIGN AND
PRODUCTION OF ITALY

Pierres des Châteaux
MARMO E PIETRA

8,8 mm R10B

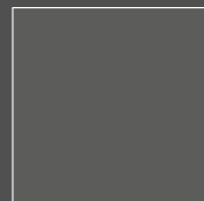

100x100
40"x40"
Nat Ret



60x120
24"x48"
Nat Ret



60x60
24"x24"
Nat Ret



30x60
12"x24"
Nat Ret



10x30
4"x12"
Nat Ret

modular system

Decori / Decors

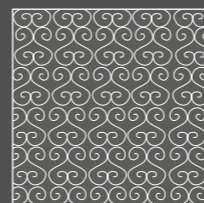

Rose 100x100
40"x40"
Nat Ret



Mosaico 30x30
12"x12"
Nat Ret



Spina di pesce 30x30
12"x12"
Nat Ret



Rete esagonale 30x26
12"x10 1/4"
Nat Ret

8,8 mm R11C



100x100
40"x40"
Nat Ret

Cheverny
Chambord
Ussé
Fontainebleau



100x100
40"x40"
Nat Ret

20 mm OUTDOOR R11C

Formati disponibili con la tecnologia ADVANCE®. Per info consulta pag. 457.

ADVANCE® technology available sizes. For more info go to page 457.

Formats disponibles avec la technologie ADVANCE®. Pour toutes informations aller à la page 457.

Verfügbare Größen mit ADVANCE®-Technologie. Für weitere Infos siehe S. 457.

Sviluppo grafico per formato
Pattern by size
Développement graphique par format
Grafischer Entwurf für Format



100x100
8,8 mm

15

60x120
8,8 mm

30

60x60
8,8 mm

16

30x60
8,8 mm

32

10x30
8,8 mm

190

100x100
20 mm

15

Sviluppo Grafico

Pattern by size. Développement graphique par format. Grafischer Entwurf für Format

FONTAINEBLEAU 60x120 8,8 mm

30 patterns



Pierres des Châteaux

MARMO E PIETRA

Decorì 8,8 mm R10B

Decors

CHENONCEAU



Champagne Black *

CHAMBORD

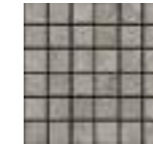

Amarone Brown *

CHEVERNY

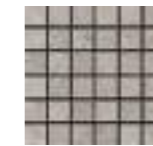
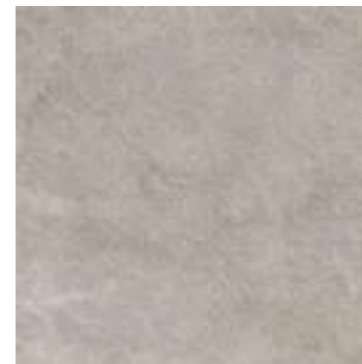

Champagne Grey *

USSÉ

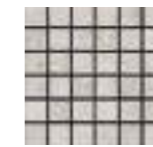
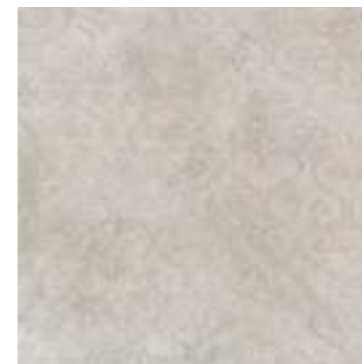

Champagne White *

Pinot grigio White *

FONTAINEBLEAU

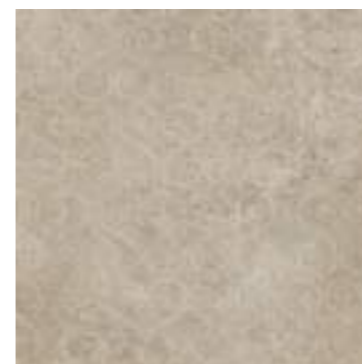

Chardonnay Beige *

Mosaico
30x30_12"x12"
Nat Ret

Spina di pesce
30x30_12"x12"
Nat Ret

Rete esagonale
30x26_12"x10 1/4"
Nat Ret

Rose 100x100_40"x40"
Nat Ret

* DECORO realizzato con la serie Pierres des Châteaux e Il Cerreto.
Decoration made with Pierres des Châteaux and Il Cerreto series.
Décor composé de Pierres des Châteaux et Il Cerreto séries.
Dekor mit der Serie Pierres des Châteaux und Il Cerreto ausgeführt.

Pierres des Châteaux

8,8 mm
R10B

	100x100 40"x40"		60x120 24"x48"		60x60 24"x24"		30x60 12"x24"		10x30 4"x12"
	Nat Ret	Nat Ret	Nat Ret	Nat Ret	Nat Ret	Nat Ret	Nat Ret	Nat Ret	Nat Ret
CHENONCEAU	158005	158065	158045	158050	158015	158020	158025	158060	158030
CHAMBORD	158002	158062	158042	158047	158012	158017	158022	158057	158027
CHEVERNY	158001	158061	158041	158046	158011	158016	158021	158056	158026
FONTAINEBLEAU	158004	158064	158044	158049	158014	158019	158024	158059	158029
USSÉ	158003	158063	158043	158048	158013	158018	158023	158058	158028
Price code	M109	M128	M097	M122	M089	M118	M081	M110	M123

8,8 mm
R10B

	100x100 40"x40"	Mosaico 30x30 12"x12"	Spina di pesce 33,5x30 13"x12"	Rete esagonale * 30x26 12"x10 1/4"
	Nat Ret	Nat Ret	Nat Ret	Nat Ret
CHENONCEAU	158055	158305	158314	MOSCP06
CHAMBORD	158052	158302	158311	MOSCP03
CHEVERNY	158051	158301	158310	MOSCP05
FONTAINEBLEAU	158054	158304	158313	MOSCP02
USSÉ	158053	158303	158312	MOSCP04 MOSCP01
Price code	M117	M159	M189	M287

8,8 mm
R11C

	100x100 40"x40"
	Nat Ret
CHENONCEAU	-
CHAMBORD	158007
CHEVERNY	158006
FONTAINEBLEAU	158009
USSÉ	158008
Price code	M109

20 mm
R11C

	100x100 40"x40"
	Nat Ret
CHENONCEAU	158075
CHAMBORD	158072
CHEVERNY	158071
FONTAINEBLEAU	158074
USSÉ	158073
Price code	M143

Formati disponibili con la tecnologia ADVANCE®. Per info consulta pag. 457.
ADVANCE® technology available sizes. For more info go to page 457.
Formats disponibles avec la technologie ADVANCE®. Pour toutes informations aller à la page 457.
Verfügbare Größen mit ADVANCE®-Technologie. Für weitere Infos siehe S. 457.

***DECORO realizzato con la serie Pierres des Châteaux e Il Cerreto.**
Decoration made with Pierres des Châteaux and Il Cerreto series.
Décor composé de Pierres des Châteaux et Il Cerreto séries.
Dekor mit der Serie Pierres des Châteaux und Il Cerreto ausgeführt.

Pezzi Speciali / Trims. Pièces speciale. Die Sonderstücke

8,8 mm

	Battiscopa Skirting		Gradino costa retta** Straight-edge stair**		Gradino costa retta SX - DX** Straight-edge step L-R			
	7x100	7x100	7x60	7x60	33x60	33x60		
	Nat Ret	Nat Ret	Nat Ret	Nat Ret	Nat Ret	Nat Ret		
CHENONCEAU	158105	158110	158115	158120	158205	158210	158225 SX 158215 DX	158231 SX 158220 DX
CHAMBORD	158102	158107	158112	158117	158202	158207	158222 SX 158212 DX	158227 SX 158217 DX
CHEVERNY	158101	158106	158111	158116	158201	158206	158221 SX 158211 DX	158226 SX 158216 DX
FONTAINEBLEAU	158104	158109	158114	158119	158204	158209	158224 SX 158214 DX	158229 SX 158219 DX
USSÉ	158103	158108	158113	158118	158203	158208	158223 SX 158213 DX	158228 SX 158218 DX
Price code	P035	P040	P021	P025	P141	P156	P169	P190

20 mm
R11C

	Gradone costa toro** Large step
	50x100 Nat Ret
CHENONCEAU	158410
CHAMBORD	158407
CHEVERNY	158411
FONTAINEBLEAU	158409
USSÉ	158408
Price code	P235

La gamma completa dei pezzi speciali è disponibile nella "PARTE TECNICA" del catalogo a pag. 493
Our entire range of trims is available in our "TECHNICAL SECTION" of this catalogue pag. 493.
La gamme complète des pièces spéciales est disponible dans la section "PARTIE TECHNIQUE" à la pag. 493 de ce catalogue.
Das komplette Sortiment an Sonderstücken ist in dem "technischen Teil" des Katalogs auf Seite 493 verfügbar.

Imballi / Packings. Emballage. Verpackung

	PCS/BOX	MQ/BOX	KG/BOX	BOX/PAL	MQ/PAL	KG/PAL	PACKING	PACKING SIZE
8,8 mm								
100 x 100	2	2,00	40	24	48,00	986	PALLET CON SPONDE	103 x 123 x 74h
100 x 100 R11	2	2,00	40	24	48,00	986	PALLET CON SPONDE	103 x 123 x 74h
60 x 120	2	1,44	27,32	32	46,08	896	EPAL	80 x 120 x 75h
60 x 60	3	1,08	20,31	40	43,20	834	EPAL	80 x 120 x 75h
30 x 60	7	1,26	24,00	48	60,48	1.174	EPAL	80 x 120 x 75h
10 x 30	19	0,57	12,05	72	41,04	889	EPAL	80 x 120 x 81h
DECORI. DECORS								
MOSAICO 30 x 30	7	0,63	13,20	60	37,80	814	EPAL	80 x 120 x 81h
SPINA DI PESCE 33,5 x 30	6	0,60	11,71	60	36,00	725	EPAL	80 x 120 x 81h
RETE ESAGONALE 30 x 26	6	0,47	10,74	60	28,20	666	EPAL	80 x 120 x 75h
ROSE 100 x 100	2	2,00	36,68	24	48,00	986	PALLET CON SPONDE	103 x 123 x 74h
20 mm								
100 x 100 R11	1	1	43,39	24	24	1.063	PALLET CON SPONDE	103 x 123 x 65h

Pallet speciale con sponde
Special pallet with sides.
Palette spéciale avec bords.
Spezial-Palette mit Wandungen.

Pallet speciale senza sponde
Special pallet without sides.
Palette spéciale sans de bords.
Spezial-Palette ohne Wandungen.

Epil / Pallet

PEZZI SPECIALI. TRIMS	PCS/BOX	MQ/BOX	KG/BOX	PACKING	PACKING SIZE
8,8 mm					
BATTISCOPA 7 x 100	6	0,42	8,10	EPAL	80 x 120
BATTISCOPA 7 x 60	15	0,63	13,28	EPAL	80 x 120
GRADINO COSTA RETTA 33 x 60 x 3,2h **	4	-	20,70	EPAL	80 x 120
GRADINO COSTA RETTA 33 x 60 x 3,2h SX/DX **	2	-	10,80	EPAL	80 x 120
20 mm					
GRADONE 50 x 100 **	1	-	15	PALLET	103 x 103

**** A disposizione solo su richiesta.**
Tempi di consegna: 30gg
Available upon request only.
Delivery terms: 30 days
Disponible seulement sur requête.
Délais de livraison: 30 jours
Verfügbar auf Anfrage.
Lieferzeit: 30 Tage



Royal Stone
MARMO E PIETRA

Royal Stone

8,8 mm R10A



100x100
40"x40"
Nat Ret



60x120
24"x48"
Nat Ret



60x60
24"x24"
Nat Ret



30x60
12"x24"
Nat Ret



30,5x60,5
12"x24"
Nat

modular system

Decoro / Decor



Mosaico 30x30
12"x12"
Nat Ret

20 mm OUTDOOR R11C



100x100
40"x40"
Nat Ret



60x60
24"x24"
Nat Ret

Sviluppo grafico per formato
Pattern by size
Développement graphique par format
Grafischer Entwurf für Format



60x120
8,8 mm

20

60x60
8,8 mm

40

30x60
8,8 mm

78

30,5x60,5
8,8 mm

78

100x100
8,8 mm
20 mm

9

60x60
20 mm

40

8,8 mm R10A						
	60x120 24"x48"	60x60 24"x24"	30x60 12"x24"	30,5x60,5 12"x24"	100x100 40"x40"	Mosaico 30x30 12"x12"
	Nat Ret	Nat Ret	Nat Ret	Nat	Nat Ret	Nat Ret
GOLD	122001	122005	122010	122008	122012	122015
Price code	M097	M083	M081	M065	M109	M135

20 mm R11C		
	100x100 40"x40"	60x60 24"x24"
	Nat Ret	Nat Ret
GOLD	122013	122007
Price code	M143	M117

Pezzi Speciali / Trims. Pièces speciale. Die Sonderstücke

8,8 mm R10A					
	Battiscopa Skirting	Gradino costa retta** Straight-edge stair**	Gradino costa retta SX - DX** Straight-edge step L-R	Gradino costa retta** Straight-edge stair**	Gradino costa retta SX - DX** Straight-edge step L-R
	9,5x60	33x60	33x60	33x120	33x120
	Nat Ret	Nat Ret	Nat Ret	Nat Ret	Nat Ret
GOLD	122020	122030	122032 SX 122031 DX	122033	122035 SX 122034 DX
Price code	P021	P135	P151	P207	P231

Pezzi Speciali / Trims. Pièces speciale. Die Sonderstücke

20 mm R11C		
	Gradone** Large step	Gradone Angolo Sx/Dx** Large step - corner L/R
	30x60	30x60
	Costa toro Nat Ret	Costa retta Nat Ret
	Costa toro Nat Ret	Costa retta Nat Ret
GOLD	122238	122235
	122240 SX 122239 DX	122237 SX 122236 DX
Price code	P135	P135
	P151	P145

20 mm R11C		
	Griglia** Drainage grid	Griglia Angolo Sx/Dx** Drainage grid - Corner L/R
	15x60	30x60
	15x60	30x60
GRIGIO	122226	122229
	122228 SX 122227 DX	122231 SX 122230 DX
Price code	P195	P217
	P195	P217

La gamma completa dei pezzi speciali è disponibile nella "PARTE TECNICA" del catalogo a pag. 493
Our entire range of trims is available in our "TECHNICAL SECTION" of this catalogue pag. 493.
La gamme complète des pièces spéciales est disponible dans la section "PARTIE TECHNIQUE" à la pag. 493 de ce catalogue.
Das komplette Sortiment an Sonderstücken ist in dem "technischen Teil" des Katalogs auf Seite 493 verfügbar.

Imballi / Packings. Emballage. Verpackung

	PCS/BOX	MQ/BOX	KG/BOX	BOX/PAL	MQ/PAL	KG/PAL	PACKING	PACKING SIZE
8,8 mm								
100 x 100	2	2,00	40,00	24	48,00	990	PALLET CON SPONDE	103 x 123 x 70h
60 x 120	2	1,44	29,82	32	46,08	994	EPAL	80 x 120 x 75h
60 x 60	3	1,08	22,64	40	43,20	954	EPAL	80 x 120 x 75h
30 x 60	7	1,26	24,00	48	60,48	1.172	EPAL	80 x 120 x 75h
30,5 x 60,5	7	1,29	23,98	40	51,60	979	EPAL	80 x 120 x 75h
DECORI. DECORS								
MOSAICO 30x30	6	0,54	12,15	54	23,16	676	EPAL	80 x 120 x 75h
20 mm								
100 x 100	1	1	43,81	24	24	1.073	PALLET CON SPONDE	103 x 123 x 65h
60 x 60	2	0,72	32,00	32	23,04	1.046	EPAL	80 x 120 x 75h

Pallet speciale con sponde
Special pallet with sides.
Palette spéciale avec bords.
Spezial-Palette mit Wandungen.

EPAL / Pallet

PEZZI SPECIALI. TRIMS	PCS/BOX	MQ/BOX	KG/BOX	PACKING	PACKING SIZE
8,8 mm					
BATTISCOPA 9,5 x 60	12	-	14,50	EPAL	80 x 120
GRADINO COSTA RETTA 33 x 60 x 3,2h **	4	-	23,00	EPAL	80 x 120
GRADINO COSTA RETTA 33 x 60 x 3,2h SX/DX **	2	-	13,00	EPAL	80 x 120
GRADINO COSTA RETTA 33 x 120 x 3,2h **	2	-	23,00	EPAL	80 x 120
GRADINO COSTA RETTA 33 x 120 x 3,2h SX/DX **	1	-	12,00	EPAL	80 x 120
20 mm					
GRADONE 15 x 60 **	1	-	4,50	EPAL	80 x 120
GRADONE 15 x 60 SX/DX **	1	-	3,80	EPAL	80 x 120
GRADONE 30 x 60 **	1	-	9,00	EPAL	80 x 120
GRADONE 30 x 60 SX/DX **	1	-	6,60	EPAL	80 x 120
GRIGLIA 15 x 60 **	1	-	4,20	EPAL	80 x 120
GRIGLIA 15 x 60 SX/DX **	1	-	3,60	EPAL	80 x 120
GRIGLIA 30 x 60 **	1	-	8,40	EPAL	80 x 120
GRIGLIA 30 x 60 SX/DX **	1	-	7,20	EPAL	80 x 120

**** A disposizione solo su richiesta.**
Tempi di consegna: 30gg
Available upon request only.
Delivery terms: 30 days
Disponible seulement sur requête. Délais de livraison: 30 jours
Verfügbar auf Anfrage.
Lieferzeit: 30 Tage

La gamma completa dei pezzi speciali è disponibile nella "PARTE TECNICA" del catalogo a pag. 493
Our entire range of trims is available in our "TECHNICAL SECTION" of this catalogue pag. 493.
La gamme complète des pièces spéciales est disponible dans la section "PARTIE TECHNIQUE" à la pag. 493 de ce catalogue.
Das komplette Sortiment an Sonderstücken ist in dem "technischen Teil" des Katalogs auf Seite 493 verfügbar.

Chianca

MARMO E PIETRA

Chianca

OTRANTO

OSTUNI

CURSI

CARPARO



ISO 13006 - G - Bla_E ≤ 0,5% - UNI EN 14411 - UGL
ANSI A - 326.3: 2021
WET DYNAMIC COEFFICIENT OF FRICTION | DCOF ≥ 0,42



Chianca
MARMO E PIETRA

8,8 mm R10B



100x100
40"x40"
Nat Ret



60x120
24"x48"
Nat Ret



60,9x60,9
24"x24"
Nat



40,6x60,9
16"x24"
Nat



40,6x40,6
16"x16"
Nat



20,3x40,6
8"x16"
Nat



20,3x20,3
8"x8"
Nat

modular system

Decori / Decors



Mosaico 30x30
12"x12"
Nat Ret



Spaccatella 30x30
12"x12"
Nat Ret



Muretto 3D 61x15
24"x6"
Nat

Otranto, Ostuni,
Carparo

8,8 mm OUTDOOR R11C



100x100
40"x40"
Nat Ret



60,9x60,9
24"x24"
Nat



40,6x60,9
16"x24"
Nat



40,6x40,6
16"x16"
Nat



20,3x40,6
8"x16"
Nat



20,3x20,3
8"x8"
Nat

modular system

Ostuni, Corsi

20 mm OUTDOOR R11C



100x100
40"x40"
Nat Ret

Sviluppo grafico per formato
Pattern by size
Développement graphique par format
Grafischer Entwurf für Format



100x100
8,8 mm

8

60x120
8,8 mm

16

60,9x60,9
8,8 mm

27

40,6x60,9
8,8 mm

27

20,3x40,6
8,8 mm

54

40,6x40,6
8,8 mm

32

20,3x20,3
8,8 mm

54

100x100
20 mm

8

CURSI 60x120 8,8 mm

16 patterns

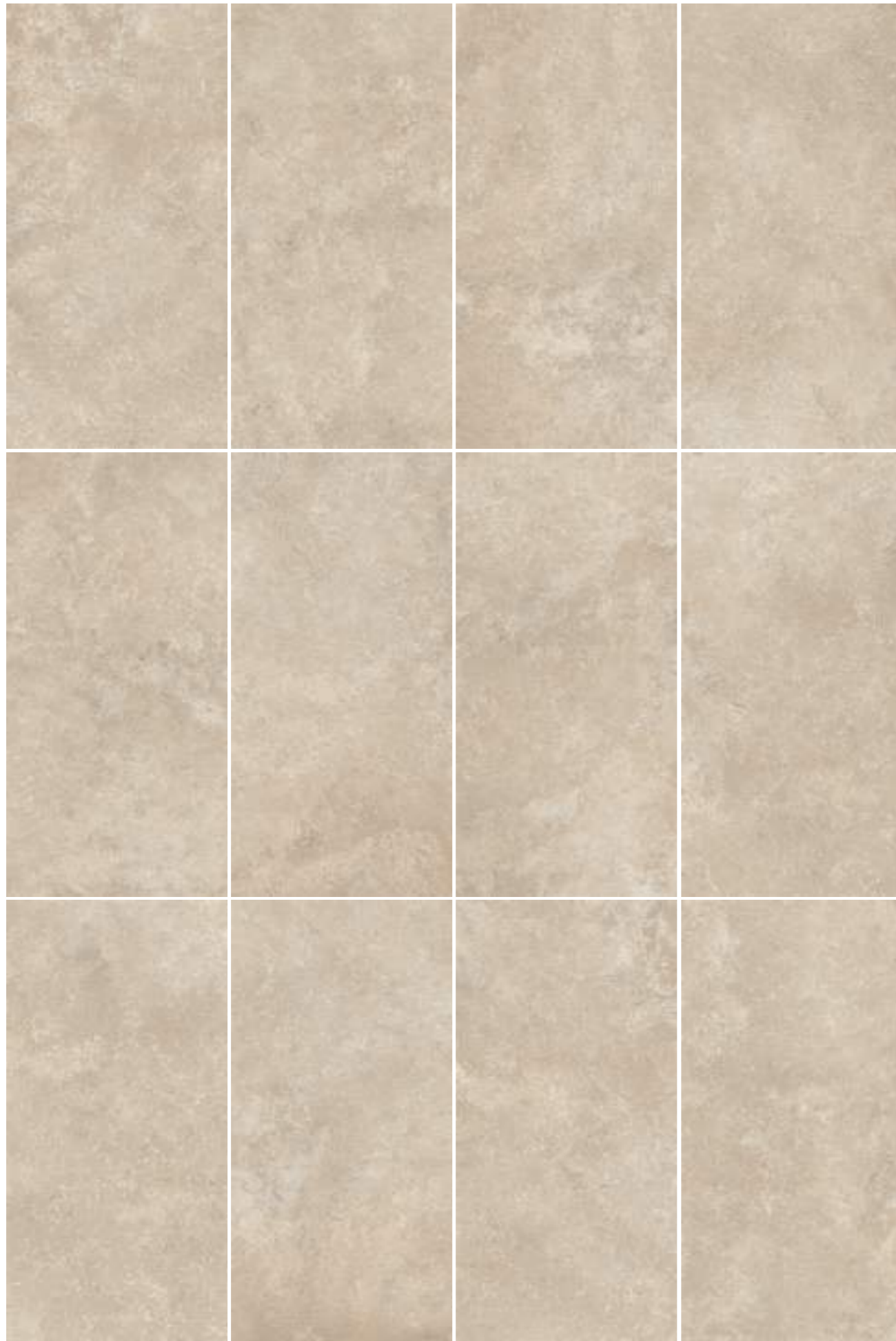

Decori

Decors

8,8 mm R10B

7|11 mm

Max 11 mm Min 7 mm

OTRANTO

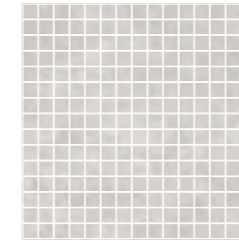
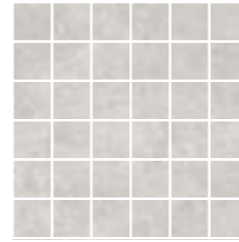

OSTUNI

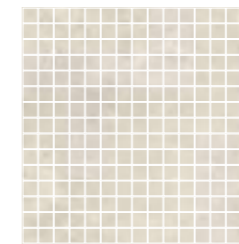

CURSI

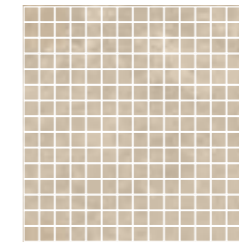
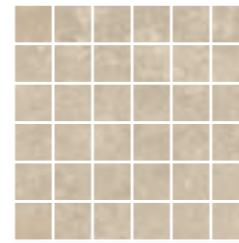

CARPARO

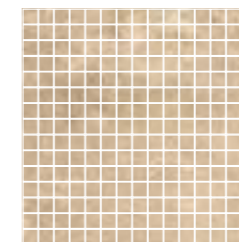

Mosaico 30x30
12"x12"
Nat Ret

Spaccatella 30x30
12"x12"
Nat Ret

Muretto 61x15
24"x6"
Nat



Wall
Spaccatella Ostuni 30x30_12"x12" Nat Ret

Floor
Ostuni 40,6x60,9_16"x24" - 40,6x40,6_16"x16"
20,3x40,6_8"x16" - 20,3x20,3_8"x8" Nat

8,8 mm
R10B

	100x100 40"x40"	60x120 24"x48"	60,9x60,9 24"x24"	40,6x60,9 12"x24"	40,6x40,6 16"x16"	20,3x40,6 8"x16"	20,3x20,3 8"x8"
	Nat Ret	Nat Ret	Nat	Nat	Nat	Nat	Nat
OTRANTO	184064	184004	184014	184024	184034	184074	184084
OSTUNI	184061	184001	184011	184021	184031	184071	184081
CURSI	184062	184002	184012	184022	184032	184072	184082
CARPARO	184063	184003	184013	184023	184033	184073	184083
Price code	M109	M097	M083	M083	M083	M083	M083

8,8 mm
R11C

	100x100 40"x40"	60,9x60,9 24"x24"	40,6x60,9 12"x24"	40,6x40,6 16"x16"	20,3x40,6 8"x16"	20,3x20,3 8"x8"	100x100 40"x40"
	Nat Ret	Nat	Nat	Nat	Nat	Nat	Nat Ret
OTRANTO	184054	-	-	-	-	-	184044
OSTUNI	184051	184015	184025	184035	184075	184085	184041
CURSI	184052	184016	184026	184036	184076	184086	184042
CARPARO	184053	-	-	-	-	-	184043
Price code	M109	M083	M083	M083	M083	M083	M143

8,8 mm
R10B

	Mosaico 30x30 12"x12"	Spaccatella 30x30 12"x12"
	Nat Ret	Nat Ret
OTRANTO	184404	184415
OSTUNI	184401	184411
CURSI	184402	184412
CARPARO	184403	184413
Price code	M159	M251

7|11 mm

	Muretto 3D 61x15 24"x6"	Muretto 3D Angolo interno 20x10x15 8"x4"x6"	Muretto 3D Angolo esterno 20x10x15 8"x4"x6"
	Nat	Nat	Nat
OTRANTO	184424	184434	184444
OSTUNI	184421	184431	184441
CURSI	-	-	-
CARPARO	184423	184433	184443
Price code	M083	P046	P045

Pezzi Speciali / Trims. Pièces speciale. Die Sonderstücke

8,8 mm
R10B

	Battiscopa Skirting	Gradino costa retta** Straight nosed stair**	Gradino costa retta SX - DX** Straight-edge step L-R
	7x100 Nat Ret	7x60 Nat Ret	33x120 Nat Ret
OTRANTO	184114	184104	184204
OSTUNI	184111	184101	184201
CURSI	184112	184102	184202
CARPARO	184113	184103	184203
Price code	P035	P021	P207

	33x120 Nat Ret	33x120 Nat Ret
OTRANTO	184224 SX 184214 DX	184224 SX 184214 DX
OSTUNI	184221 SX 184211 DX	184221 SX 184211 DX
CURSI	184222 SX 184212 DX	184222 SX 184212 DX
CARPARO	184223 SX 184213 DX	184223 SX 184213 DX
Price code	P231	P231

Pezzi Speciali / Trims. Pièces speciale. Die Sonderstücke

8,8 mm
R11C

	Elemento Elle monolitico** L-shaped monoblock tile
	15x30x4 Nat
OTRANTO	-
OSTUNI	184231
CURSI	184232
CARPARO	-
Price code	P044

20 mm
R11C

	Gradone** Large step	Gradone Angolo Sx/Dx** Large step - Corner L/R
	50x100 Costa toro Nat Ret	50x100 Costa toro Nat Ret
OTRANTO	184244	184264 SX 184254 DX
OSTUNI	184241	184261 SX 184251 DX
CURSI	184242	184262 SX 184252 DX
CARPARO	184243	184263 SX 184253 DX
Price code	P235	P253

La gamma completa dei pezzi speciali è disponibile nella "PARTE TECNICA" del catalogo a pag. 493
 Our entire range of trims is available in our "TECHNICAL SECTION" of this catalogue pag. 493.
 La gamme complète des pièces spéciales est disponible dans la section "PARTIE TECHNIQUE" à la pag. 493 de ce catalogue.
 Das komplette Sortiment an Sonderstücken ist in dem "technischen Teil" des Katalogs auf Seite 493 verfügbar.

Imballi / Packings. Emballage. Verpackung

	PCS/BOX	MQ/BOX	KG/BOX	BOX/PAL	MQ/PAL	KG/PAL	PACKING	PACKING SIZE
8,8 mm								
100 x 100	2	2	40,00	24	48	990	PALLET CON SPONDE	103 x 123 x 70h
100 x 100 R11C	2	2	40,00	24	48	990	PALLET CON SPONDE	103 x 123 x 70h
60 x 120	2	1,44	27,28	32	46,08	893	EPAL	80 x 120 x 75h
60,9 x 60,9	3	1,11	20,98	40	44,40	860	EPAL	80 x 120 x 75h
60,9 x 60,9 R11C	3	1,11	20,98	40	44,40	860	EPAL	80 x 120 x 75h
40,6 x 60,9	6	1,48	30,00	40	59,20	1.220	EPAL	80 x 120 x 96h
40,6 x 60,9 R11C	6	1,48	30,00	40	59,20	1.220	EPAL	80 x 120 x 96h
40,6 x 40,6	6	0,99	17,20	72	71,28	1.258	EPAL	80 x 120 x 96h
40,6 x 40,6 R11C	6	0,99	17,20	72	71,28	1.258	EPAL	80 x 120 x 96h
20,3 x 40,6	13	1,07	19,10	72	77,04	1.396	EPAL	80 x 120 x 96h
20,3 x 40,6 R11C	13	1,07	19,10	72	77,04	1.396	EPAL	80 x 120 x 96h
20,3 x 20,3	30	1,24	22,45	60	74,40	1.367	EPAL	80 x 120 x 96h
20,3 x 20,3 R11C	30	1,24	22,45	60	74,40	1.367	EPAL	80 x 120 x 96h
DECORI. DECORS								
MOSAICO 30 x 30	6	0,54	10,36	60	32,40	642	EPAL	80 x 120
SPACCATELLA 30 x 30	6	0,54	10,36	60	32,40	642	EPAL	80 x 120

7|11 mm

	PCS/BOX	MQ/BOX	KG/BOX	BOX/PAL	MQ/PAL	KG/PAL	PACKING	PACKING SIZE
DECORI. DECORS								
MURETTO 3D 61x15	11	1,02	19,38	48	48,96	950	EPAL	80 x 120
MURETTO 3D ANGOLO INTERNO 20x10x15	6	-	-	48	-	-	EPAL	80 x 120
MURETTO 3D ANGOLO ESTERNO 20x10x15	6	-	-	48	-	-	EPAL	80 x 120

20 mm

	PCS/BOX	MQ/BOX	KG/BOX	BOX/PAL	MQ/PAL	KG/PAL	PACKING	PACKING SIZE
100 x 100 R11C	1	1	43,27	24	24	1.060	PALLET CON SPONDE	103 x 103 x 65h

PEZZI SPECIALI. TRIMS

	PCS/BOX	MQ/BOX	KG/BOX	PACKING	PACKING SIZE
8,8 mm					
BATTISCOPA 7 x 100	6	0,42	8,10	EPAL	80 x 120
BATTISCOPA 7 x 60	15	0,63	13,28	EPAL	80 x 120
GRADINO COSTA RETTA 33 x 120 x 3,2h **	2	-	20,70	EPAL	80 x 120
GRADINO COSTA RETTA 33 x 120 x 3,2h SX/DX **	1	-	10,80	EPAL	80 x 120
ELLE MONOLITICO 15 x 30 x 4h **	8	-	10,40	EPAL	80 x 120
20 mm					
GRADONE 50 x 100 **	1	-	15	PALLET	103 x 103
GRADONE 50 x 100 SX/DX **	1	-	15	PALLET	103 x 103

**** A disposizione solo su richiesta.**
Tempi di consegna: 30gg
 Available upon request only.
 Delivery terms: 30 days
 Disponible seulement sur requête.
 Délais de livraison: 30 jours
 Verfügbar auf Anfrage.
 Lieferzeit: 30 Tage





*Arde.
sia*

Ardesia
MARMO E PIETRA

GRIGIO

CENERE

TAUPE

BIANCO

V2
SHADE SPECTRUM
MODERATE

ISO 13006 - G - Bla_E ≤ 0,5% - UNI EN 14411 - UGL
ANSI A - 326.3: 2021
WET DYNAMIC COEFFICIENT OF FRICTION | DCOF ≥ 0,42

100% DESIGN AND
PRODUCTION OF ITALY

Ardesia
MARMO E PIETRA

8,8 mm R10B



60x120
24"x48"
Nat Ret



60x60
24"x24"
Nat Ret



30x60
12"x24"
Nat Ret



30,5x60,5
12"x24"
Nat



80x80
31 1/2"x31 1/2"
Nat Ret

modular system

Decor / Decors



Mosaico 30x30
12"x12"
Nat Ret



Muretto 3D 15x61
6"x24"
Nat

Max 11 mm Min 7 mm

8,8 mm OUTDOOR R11C



60x120
24"x48"
Nat Ret



80x80
31 1/2"x31 1/2"
Nat Ret

20 mm OUTDOOR R11C



40x120
16"x48"
Nat Ret



80x80
31 1/2"x31 1/2"
Nat Ret

Sviluppo grafico per formato
Pattern by size
Développement graphique par format
Grafischer Entwurf für Format



60x120
8,8 mm

19

60x60
8,8 mm

31

30x60
8,8 mm

62

30,5x60,5
8,8 mm

62

80x80
8,8 mm

23

40x120
20 mm

28

80x80
20 mm

23

Sviluppo Grafico

Pattern by size. Développement graphique par format. Grafischer Entwurf für Format

BIANCO 60x120 8,8 mm

19 patterns



8,8 mm
R 10B

	60x120 24"x48"	60x60 24"x24"	30x60 12"x24"	30,5x60,5 12"x24"	80x80 31 1/2"x31 1/2"
	Nat Ret	Nat Ret	Nat Ret	Nat	Nat Ret
GRIGIO	137004	137028	137040	137034	137016
CENERE	137003	137027	137039	137033	137015
TAUPE	137002	137026	137038	137032	137014
BIANCO	137001	137025	137037	137031	137013
Price code	M097	M083	M081	M065	M097

8,8 mm
R 11C

	60x120 24"x48"	80x80 31 1/2"x31 1/2"
	Nat Ret	Nat Ret
GRIGIO	137010	137022
CENERE	137009	137021
TAUPE	137008	137020
BIANCO	137007	137019
Price code	M097	M097

20 mm
R 11C

	40x120 16"x48"	80x80 31 1/2"x31 1/2"
	Nat Ret	Nat Ret
GRIGIO	137053	137060
CENERE	137052	137059
TAUPE	137051	137058
BIANCO	137050	137057
Price code	M131	M137

8,8 mm
R 10B

Mosaico 30x30
12"x12"

	Nat Ret
GRIGIO	137204
CENERE	137203
TAUPE	137202
BIANCO	137201
Price code	M135

7,11 mm

Muretto 3D 15x61
6"x24"

	Nat
GRIGIO	137046
CENERE	137045
TAUPE	137044
BIANCO	137043
Price code	M083

Pezzi Speciali / Trims. Pièces speciale. Die Sonderstücke

8,8 mm R10B

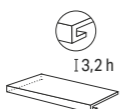
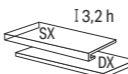
	6,5x120	8x80	33x120	33x80	33x60	33x120	33x80	33x60
	Nat Ret	Nat Ret	Nat Ret	Nat Ret	Nat Ret	Nat Ret	Nat Ret	Nat Ret
GRIGIO	137104	137114	137350	137330	137310	137352 SX 137351 DX	137332 SX 137331 DX	137312 SX 137311 DX
CENERE	137103	137112	137344	137324	137304	137346 SX 137345 DX	137326 SX 137325 DX	137306 SX 137305 DX
TAUPE	137102	137113	137347	137327	137307	137349 SX 137348 DX	137329 SX 137328 DX	137309 SX 137308 DX
BIANCO	137101	137111	137341	137321	137301	137343 SX 137342 DX	137323 SX 137322 DX	137303 SX 137302 DX
Price code	P040	P029	P207	P167	P135	P219	P179	P151

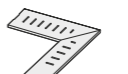

20 mm R11C

	20x80	20x60	20x80	20x60
GRIGIO	137772	137760	137780 SX 137776 DX	137768 SX 137764 DX
CENERE	137770	137758	137778 SX 137774 DX	137766 SX 137762 DX
TAUPE	137771	137759	137779 SX 137775 DX	137767 SX 137763 DX
BIANCO	137769	137757	137777 SX 137773 DX	137765 SX 137761 DX
Price code	P239	P205	P239	P205

La gamma completa dei pezzi speciali è disponibile nella "PARTE TECNICA" del catalogo a pag. 493
Our entire range of trims is available in our "TECHNICAL SECTION" of this catalogue pag. 493.
La gamme complète des pièces spéciales est disponible dans la section "PARTIE TECHNIQUE" à la pag. 493 de ce catalogue.
Das komplette Sortiment an Sonderstücken ist in dem "technischen Teil" des Katalogs auf Seite 493 verfügbar.

8,8 mm R11C

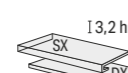
	33x120	33x80	33x120	33x80	30x120
	Nat Ret	Nat Ret	Nat Ret	Nat Ret	Nat Ret
GRIGIO	137390	137370	137392 SX 137391 DX	137372 SX 137371 DX	137154
CENERE	137384	137364	137386 SX 137385 DX	137366 SX 137365 DX	137153
TAUPE	137387	137367	137389 SX 137388 DX	137369 SX 137368 DX	137152
BIANCO	137381	137361	137383 SX 137382 DX	137363 SX 137362 DX	137151
Price code	P207	P167	P219	P179	P163

20 mm R11C

	40x120		40x80		40x120		40x80	
	Costa toro Nat Ret	Costa retta Nat Ret	Costa toro Nat Ret	Costa retta Nat Ret	Costa toro Nat Ret	Costa retta Nat Ret	Costa toro Nat Ret	Costa retta Nat Ret
GRIGIO	137628	137616	137652	137640	137636 SX 137632 DX	137624 SX 137620 DX	137660 SX 137656 DX	137648 SX 137644 DX
CENERE	137626	137614	137650	137638	137634 SX 137630 DX	137622 SX 137618 DX	137658 SX 137654 DX	137646 SX 137642 DX
TAUPE	137627	137615	137651	137639	137635 SX 137631 DX	137623 SX 137619 DX	137659 SX 137655 DX	137647 SX 137643 DX
BIANCO	137625	137613	137649	137637	137633 SX 137629 DX	137621 SX 137617 DX	137657 SX 137653 DX	137645 SX 137641 DX
Price code	P219	P211	P181	P175	P251	P239	P203	P197

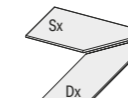
Imballi / Packings. Emballage. Verpackung

	PCS/BOX	MQ/BOX	KG/BOX	BOX/PAL	MQ/PAL	KG/PAL	PACKING	PACKING SIZE
8,8 mm								
60 x 120	2	1,44	33,13	32	46,08	1.080	EPAL	80 x 120 x 75h
60 x 120 R11	2	1,44	33,13	32	46,08	1.080	EPAL	80 x 120 x 75h
60 x 60	3	1,08	25,38	40	43,20	1.035	EPAL	80 x 120 x 75h
30 x 60	7	1,26	24,00	48	60,48	1.172	EPAL	80 x 120 x 75h
30,5x60,5	7	1,29	23,98	40	51,60	980	EPAL	80 x 120 x 75h
80 x 80	2	1,28	24,35	50	64,00	1.237	EPAL	80 x 120 x 95h
80 x 80 R11	2	1,28	24,35	50	64,00	1.237	EPAL	80 x 120 x 95h
DECORI. DECORS								
MOSAICO 30x30	6	0,54	13,00	54	29,16	722	EPAL	80 x 120 x 75h
7 11 mm								
DECORI. DECORS								
MURETTO 3D 15x61	11	1,02	19,38	48	48,96	950	EPAL	80 x 120 x 76h
20 mm								
40 x 120	2	0,96	43,00	24	23,04	1.052	EPAL	80 x 120 x 75h
80 x 80	1	0,64	27,77	40	25,60	1.130	EPAL	80 x 120 x 95h



PEZZI SPECIALI. TRIMS

	PCS/BOX	MQ/BOX	KG/BOX	PACKING	PACKING SIZE
8,8 mm					
BATTISCOPA 6,5 x 120	6	-	11,04	EPAL	80 x 120
BATTISCOPA 8 x 80	10	-	15,00	EPAL	80 x 120
GRADINO COSTA RETTA 33 x 120 x 3,2h **	2	-	23,00	EPAL	80 x 120
GRADINO COSTA RETTA 33 x 120 x 3,2h SX/DX **	1	-	12,00	EPAL	80 x 120
GRADINO COSTA RETTA 33 x 80 x 3,2h **	2	-	16,00	EPAL	80 x 120
GRADINO COSTA RETTA 33 x 80 x 3,2h SX/DX **	1	-	8,50	EPAL	80 x 120
GRADINO COSTA RETTA 33 x 60 x 3,2h **	4	-	23,00	EPAL	80 x 120
GRADINO COSTA RETTA 33 x 60 x 3,2h SX/DX **	2	-	12,00	EPAL	80 x 120
ELEMENTO A L INCOLLATO 30 x 120 x 4h **	2	-	20,00	EPAL	80 x 120
20 mm					
GRADONE 40 x 120 **	1	-	21,50	EPAL	80 x 120
GRADONE 40 x 120 SX/DX **	1	-	21,50	EPAL	80 x 120
GRADONE 40 x 80 **	1	-	12,50	EPAL	80 x 120
GRADONE 40 x 80 SX/DX **	1	-	12,50	EPAL	80 x 120
GRIGLIA 20 x 80 **	1	-	8,00	EPAL	80 x 120
GRIGLIA 20 x 80 SX/DX **	1	-	7,50	EPAL	80 x 120
GRIGLIA 20 x 60 **	1	-	6,00	EPAL	80 x 120
GRIGLIA 20 x 60 SX/DX **	1	-	5,50	EPAL	80 x 120

**** A disposizione solo su richiesta. Tempi di consegna: 30gg**
Available upon request only.
Delivery terms: 30 days
Disponible seulement sur requête. Délais de livraison: 30 jours
Verfügbar auf Anfrage.
Lieferzeit: 30 Tage

La gamma completa dei pezzi speciali è disponibile nella "PARTE TECNICA" del catalogo a pag. 493
Our entire range of trims is available in our "TECHNICAL SECTION" of this catalogue pag. 493.
La gamme complète des pièces spéciales est disponible dans la section "PARTIE TECHNIQUE" à la pag. 493 de ce catalogue.
Das komplette Sortiment an Sonderstücken ist in dem "technischen Teil" des Katalogs auf Seite 493 verfügbar.



Storm

Storm
MARMO E PIETRA

DARK

FOG

SALT

SAND

V2
SHADE SPECTRUM
MODERATE

ISO 13006 - G - Bla_E ≤ 0,5% - UNI EN 14411 - UGL
ANSI A - 326.3: 2021
WET DYNAMIC COEFFICIENT OF FRICTION | DCOF ≥ 0,42

100 % DESIGN AND
PRODUCTION OF ITALY

Storm
MARMO E PIETRA

8,8 mm R10B



80x180
31 1/2"x71"
Nat Ret

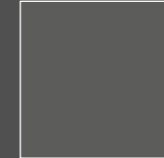

80x80
31 1/2"x31 1/2"
Nat Ret



60x120
24"x48"
Nat Ret



60x60
24"x24"
Nat Ret



30x60
12"x24"
Nat Ret

modular system

modular system

Decori / Decors



Mosaico 30x30
12"x12"
Nat Ret

8,8 mm OUTDOOR R11C



30,5x60,5
12"x24"
Nat

20 mm OUTDOOR R11C



80x80
31 1/2"x31 1/2"
Nat Ret



60x60
24"x24"
Nat Ret

Sviluppo grafico per formato
Pattern by size
Développement graphique par format
Grafischer Entwurf für Format



80x180
8,8 mm

12

80x80
8,8 mm

24

60x120
8,8 mm

24

60x60
8,8 mm

52

30x60
8,8 mm

76

30,5x60,5
8,8 mm

76

80x80
20 mm

24

60x60
20 mm

52

Sviluppo Grafico

Pattern by size. Développement graphique par format. Grafischer Entwurf für Format

FOG 60x120 8,8 mm

24 patterns



Floor
Fog 80x180_31 1/2"x71" - 80x80_31 1/2"x31 1/2" Nat Ret
Fog Gradino Costa Retta 33x80x3,2h_13"x31 1/2"x1 1/4" h

8,8 mm
R10B

	80x180 31 1/2"x71"	80x80 31 1/2"x31 1/2"	60x120 24"x48"	60x60 24"x24"	30x60 12"x24"	Mosaico 30x30 12"x12"
	Nat Ret	Nat Ret	Nat Ret	Nat Ret	Nat Ret	Nat Ret
DARK	117004	117021	117013	117046	117071	117093
FOG	117003	117020	117012	117045	117070	117092
SALT	117001	117018	117010	117043	117068	117090
SAND	117002	117019	117011	117044	117069	117091
Price code	M125	M097	M097	M083	M081	M135

8,8 mm
R11C

	30,5x60,5 12"x24"
	Nat
DARK	117063
FOG	117062
SALT	117060
SAND	117061
Price code	M065

20 mm
R11C

	80x80 31 1/2"x31 1/2"	60x60 24"x24"
	Nat Ret	Nat Ret
DARK	117026	117051
FOG	117025	117050
SALT	117023	117048
SAND	117024	117049
Price code	M137	M117

Pezzi Speciali / Trims. Pièces speciale. Die Sonderstücke



8,8 mm
R10B

Battiscopa
Skirting



Gradino costa retta**
Straight-edge stair**

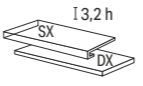

Gradino costa retta SX - DX**
Straight-edge step L-R

	6,5x120	7x60	33x120	33x80	33x60	33x120	33x80	33x60
	Nat Ret		Nat Ret		Nat Ret		Nat Ret	
DARK	117098	117104	117210	117222	117234	117212 SX 117211 DX	117224 SX 117223 DX	117236 SX 117235 DX
FOG	117097	117103	117207	117219	117231	117209 SX 117208 DX	117221 SX 117220 DX	117233 SX 117232 DX
SALT	117095	117101	117201	117213	117225	117203 SX 117202 DX	117215 SX 117214 DX	117227 SX 117226 DX
SAND	117096	117102	117204	117216	117228	117206 SX 117205 DX	117218 SX 117217 DX	117230 SX 117229 DX
Price code	P040	P021	P207	P167	P135	P219	P179	P151



20 mm
R11C

Griglia**
Drainage grid

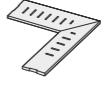

Griglia - Angolo Sx/Dx**
Drainage grid - Corner L/R

	15x60	20x80	30x60	15x60	20x80	30x60
DARK	117494	117470	117706	117708 SX 117498 DX	117478 SX 117474 DX	117514 SX 117510 DX
FOG	117493	117469	117705	117707 SX 117497 DX	117477 SX 117473 DX	117513 SX 117509 DX
SALT	117491	117467	117703	117499 SX 117495 DX	117475 SX 117471 DX	117511 SX 117507 DX
SAND	117492	117468	117704	117500 SX 117496 DX	117476 SX 117472 DX	117512 SX 117508 DX
Price code	P195	P239	P217	P195	P239	P217

La gamma completa dei pezzi speciali è disponibile nella "PARTE TECNICA" del catalogo a pag. 493. Our entire range of trims is available in our "TECHNICAL SECTION" of this catalogue pag. 493. La gamme complète des pièces spéciales est disponible dans la section "PARTIE TECHNIQUE" à la pag. 493 de ce catalogue. Das komplette Sortiment an Sonderstücken ist in dem "technischen Teil" des Katalogs auf Seite 493 verfügbar.

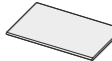

20 mm
R11C

Gradone**
Large step

	40x80		30x60	
	Costa toro Nat Ret	Costa retta Nat Ret	Costa toro Nat Ret	Costa retta Nat Ret
DARK	117418	117407	1170606	117594
FOG	117417	117406	117605	117593
SALT	117416	117404	117603	117591
SAND	117251	117405	117604	117592
Price code	P181	P175	P135	P135

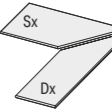

20 mm
R11C

Gradone Angolo Sx/Dx
Large step - Corner L/R

	40x80		30x60	
	Costa toro Nat Ret	Costa retta Nat Ret	Costa toro Nat Ret	Costa retta Nat Ret
DARK	117426 SX 117422 DX	117415 SX 117411 DX	117614 SX 117610 DX	117602 SX 117598 DX
FOG	117425 SX 117421 DX	117414 SX 117410 DX	117613 SX 117609 DX	117601 SX 117597 DX
SALT	117423 SX 117419 DX	117412 SX 117408 DX	117611 SX 117607 DX	117599 SX 117595 DX
SAND	117424 SX 117420 DX	117413 SX 117409 DX	117612 SX 117608 DX	117600 SX 117596 DX
Price code	P203	P197	P151	P145

Imballi / Packings. Emballage. Verpackung

	PCS/BOX	MQ/BOX	KG/BOX	BOX/PAL	MQ/PAL	KG/PAL	PACKING	PACKING SIZE
8,8 mm								
80 x 180	2	2,88	55,90	20	57,60	1.156	PALLET CON SPONDE	184 x 97 x 45h
80 x 80	2	1,28	23,30	50	64	1.187	EPAL	80 x 120 x 95h
60 x 120	2	1,44	28	32	46,08	918	EPAL	80 x 120 x 75h
60 x 60	3	1,08	19,73	40	43,20	811	EPAL	80 x 120 x 75h
30 x 60	7	1,26	24,06	48	60,48	1.177	EPAL	80 x 120 x 75h
30,5 x 60,5 R11	7	1,29	24,60	40	51,60	984	EPAL	80 x 120 x 75h
DECORI. DECORS								
MOSAICO 30 x 30	6	0,54	12,15	-	-	-	EPAL	80 x 120
20 mm								
80 x 80	2	1,28	55,55	24	30,72	1.335	EPAL	80 x 120 x 95h
60 x 60	2	0,72	32	32	23,04	1.046	EPAL	80 x 120 x 75h



Pallet speciale con sponde
Special pallet with sides.
Palette spéciale avec bords.
Spezial-Palette mit Wandungen.

PEZZI SPECIALI. TRIMS	PCS/BOX	MQ/BOX	KG/BOX	PACKING	PACKING SIZE
8,8 mm					
BATTISCOPA 6,5 x 120	6	-	11,00	EPAL	80 x 120
BATTISCOPA 7 x 60	15	-	14,76	EPAL	80 x 120
GRADINO COSTA RETTA 33 x 120 **	2	-	23,00	EPAL	80 x 120
GRADINO COSTA RETTA 33 x 120 Sx/Dx **	1	-	12,00	EPAL	80 x 120
GRADINO COSTA RETTA 33 x 80 **	2	-	16,00	EPAL	80 x 120
GRADINO COSTA RETTA 33 x 80 Sx/Dx **	1	-	8,50	EPAL	80 x 120
GRADINO COSTA RETTA 33 x 60 **	4	-	23,00	EPAL	80 x 120
GRADINO COSTA RETTA 33 x 60 Sx/Dx **	2	-	12,00	EPAL	80 x 120
20 mm					
GRADONE 40 x 80 **	1	-	12,50	EPAL	80 x 120
GRADONE 40 x 80 SX/DX **	1	-	12,50	EPAL	80 x 120
GRADONE 30 x 60 **	1	-	9,00	EPAL	80 x 120
GRADONE 30 x 60 SX/DX **	1	-	6,60	EPAL	80 x 120
GRADONE 15 x 60 **	1	-	4,50	EPAL	80 x 120
GRADONE 15 x 60 SX/DX **	1	-	3,80	EPAL	80 x 120
GRIGLIA 15 x 60 **	1	-	4,20	EPAL	80 x 120
GRIGLIA 15 x 60 SX/DX **	1	-	3,60	EPAL	80 x 120
GRIGLIA 20 x 80 **	1	-	8,00	EPAL	80 x 120
GRIGLIA 20 x 80 SX/DX **	1	-	7,50	EPAL	80 x 120
GRIGLIA 30 x 60 **	1	-	8,40	EPAL	80 x 120
GRIGLIA 30 x 60 SX/DX **	1	-	7,20	EPAL	80 x 120

**** A disposizione solo su richiesta. Tempi di consegna: 30gg**
Available upon request only.
Delivery terms: 30 days
Disponible seulement sur requête.
Délais de livraison: 30 jours
Verfügbar auf Anfrage.
Lieferzeit: 30 Tage

La gamma completa dei pezzi speciali è disponibile nella "PARTE TECNICA" del catalogo a pag. 493. Our entire range of trims is available in our "TECHNICAL SECTION" of this catalogue pag. 493. La gamme complète des pièces spéciales est disponible dans la section "PARTIE TECHNIQUE" à la pag. 493 de ce catalogue. Das komplette Sortiment an Sonderstücken ist in dem "technischen Teil" des Katalogs auf Seite 493 verfügbar.

Dolomiti

Dolomiti
MARMO E PIETRA

BASALTO

CENERE

CALCITE

SABBIA



ISO 13006 - G - Bla_E ≤ 0,5% - UNI EN 14411 - GL
ANSI A - 326.3: 2021
WET DYNAMIC COEFFICIENT OF FRICTION



Dolomiti
MARMO E PIETRA

8,8 mm R10B (Liscio/Liscio Ret)



60x120
24"x48"
Liscio Ret



60x60
24"x24"
Liscio Ret
Liscio Lap Ret



30x60
12"x24"
Liscio Ret
Liscio Lap Ret



30,5x60,5
12"x24"
Liscio

modular system

8,8 mm OUTDOOR R11C



60x120
24"x48"
Strutturato Ret



60x60
24"x24"
Strutturato Ret



30,5x60,5
12"x24"
Strutturato

20 mm OUTDOOR R11C



40x120
16"x48"
Strutturato Ret

Sviluppo grafico per formato
Pattern by size
Développement graphique par format
Grafischer Entwurf für Format



60x120
8,8 mm
19

60x60
8,8 mm
44

30x60
8,8 mm
12

30,5x60,5
8,8 mm
12

40x120
20 mm
24

CENERE 60x120 8,8 mm

19 patterns



8,8 mm
R 10B

	60x120 24"x48"	60x60 24"x24"	30x60 12"x24"	30,5x60,5 12"x24"		
	Liscio Ret	Liscio Ret	Liscio Lap Ret	Liscio Lap Ret	Liscio	
BASALTO	086019	086059	086061	086117	086119	086089
CENERE	086013	086053	086055	086111	086113	086083
CALCITE	086001	086041	086043	086101	086103	086071
SABBIA	086007	086047	086049	086107	086109	086077
Price code	M109	M089	M113	M089	M113	M073

8,8 mm
R 11C

	60x120 24"x48"	60x60 24"x24"	30,5x60,5 12"x24"
	Strutturato Ret	Strutturato Ret	Strutturato
BASALTO	086022	086062	086091
CENERE	086016	086056	086085
CALCITE	086004	086044	086073
SABBIA	086010	086050	086079
Price code	M109	M089	M073

20 mm
R 11C

	40x120 16"x48"
	Strutturato Ret
BASALTO	086034
CENERE	086033
CALCITE	086031
SABBIA	086032
Price code	M131

Dolomiti

Pezzi Speciali / Trims. Pièces speciale. Die Sonderstücke

8,8 mm
R 10B

Battiscopa
Skirting

9,5x60

	Liscio Ret	Liscio Lap Ret
BASALTO	086193	086195
CENERE	086187	086189
CALCITE	086175	086177
SABBIA	086181	086183
Price code	P021	P025

8,8 mm
R 10B

Gradino costa retta**
Straight-edge stair**

Gradino costa retta SX - DX**
Straight-edge step L-R

	33x120			33x60		
	Liscio Ret	Liscio Ret	Liscio Lap Ret	Liscio Ret	Liscio Ret	Liscio Lap Ret
BASALTO	086613	086664	086666	086645 SX 086628 DX	086831 SX 086819 DX	086833 SX 086821 DX
CENERE	086609	086803	086809	086641 SX 086625 DX	086828 SX 086816 DX	086830 SX 086818 DX
CALCITE	086601	086802	086805	086631 SX 086619 DX	086822 SX 086810 DX	086824 SX 086812 DX
SABBIA	086606	086806	086808	086634 SX 086622 DX	086825 SX 086813 DX	086827 SX 086815 DX
Price code	P207	P141	P143	P231	P169	P173

20 mm
R 11C

Gradone**
Large step

Gradone Angolo Sx/Dx**
Large step - corner L/R

Griglia**
Drainage grid

Griglia Angolo Sx/Dx**
Drainage grid Corner L/R

	40x120		40x120		20x60	20x60
	Costa toro Strut Ret	Costa retta Strut Ret	Costa toro Strut Ret	Costa retta Strut Ret		
BASALTO	086236	086230	086260 SX 086248 DX	086254 SX 086242 DX	086356	086360 SX 086352 DX
CENERE	086235	086229	086259 SX 086247 DX	086253 SX 086241 DX	086355	086359 SX 086351 DX
CALCITE	086233	086227	086257 SX 086245 DX	086251 SX 086239 DX	086353	086357 SX 086349 DX
SABBIA	086234	086228	086258 SX 086246 DX	086252 SX 086240 DX	086354	086358 SX 086350 DX
Price code	P219	P211	P251	P239	P205	P205

La gamma completa dei pezzi speciali è disponibile nella "PARTE TECNICA" del catalogo a pag. 493

Our entire range of trims is available in our "TECHNICAL SECTION" of this catalogue pag. 493.

La gamme complète des pièces spéciales est disponible dans la section "PARTIE TECHNIQUE" à la pag. 493 de ce catalogue.

Das komplette Sortiment an Sonderstücken ist in dem "technischen Teil" des Katalogs auf Seite 493 verfügbar.



Floor
Cenero 40x120_16"x48" 20mm R11

Imballi / Packings. Emballage. Verpackung

	PCS/BOX	MQ/BOX	KG/BOX	BOX/PAL	MQ/PAL	KG/PAL	PACKING	PACKING SIZE
8,8 mm								
60 x 120	2	1,44	27,90	32	46,08	894	EPAL	80 x 120 x 75h
60 x 60	3	1,08	21	40	43,20	842	EPAL	80 x 120 x 75h
30 x 60 Liscio Ret	7	1,26	24	48	60,48	1.154	EPAL	80 x 120 x 75h
30 x 60 Liscio Lap Ret	6	1,08	21	40	43,20	842	EPAL	80 x 120 x 75h
30,5 x 60,5	7	1,29	24,60	40	51,60	986	EPAL	80 x 120 x 75h
20 mm								
40 x 120	2	0,96	43,01	24	23,04	1.054	EPAL	80 x 120 x 75h



PEZZI SPECIALI. TRIMS	PCS/BOX	MQ/BOX	KG/BOX	PACKING	PACKING SIZE
8,8 mm					
BATTISCOPA 9,5 x 60	12	-	14,50	EPAL	80 x 120
GRADINO COSTA RETTA 33 x 120 x 3,2h **	2	-	23,00	EPAL	80 x 120
GRADINO COSTA RETTA 33 x 120 x 3,2h SX/DX **	1	-	12,00	EPAL	80 x 120
GRADINO COSTA RETTA 33 x 60 x 3,2h **	4	-	23,00	EPAL	80 x 120
GRADINO COSTA RETTA 33 x 60 x 3,2h SX/DX **	2	-	12,00	EPAL	80 x 120
20 mm					
GRADONE 40 x 120 **	1	-	22,50	EPAL	80 x 120
GRADONE 40 x 120 Sx/Dx **	1	-	22,50	EPAL	80 x 120
GRIGLIA 20 x 60 **	1	-	6,00	EPAL	80 x 120
GRIGLIA 20 x 60 Sx/Dx **	1	-	6,00	EPAL	80 x 120

** A disposizione solo su richiesta.

Tempi di consegna: 30gg

Available upon request only.

Delivery terms: 30 days

Disponible seulement sur requête.

Délais de livraison: 30 jours

Verfügbar auf Anfrage.

Lieferzeit: 30 Tage

La gamma completa dei pezzi speciali è disponibile nella "PARTE TECNICA" del catalogo a pag. 493

Our entire range of trims is available in our "TECHNICAL SECTION" of this catalogue pag. 493.

La gamme complète des pièces spéciales est disponible dans la section "PARTIE TECHNIQUE" à la pag. 493 de ce catalogue.

Das komplette Sortiment an Sonderstücken ist in dem "technischen Teil" des Katalogs auf Seite 493 verfügbar.

Blue Evo lution

Blue Evolution

MARMO E PIETRA

BLACK

ANTHRACITE

GREY

V2
SHADE SPECTRUM
MODERATE

ISO 13006 - G - Bla_E ≤ 0,5% - UNI EN 14411 - UGL
ANSI A - 326.3: 2021
WET DYNAMIC COEFFICIENT OF FRICTION | DCOF ≥ 0,42

100 % DESIGN AND
PRODUCTION OF ITALY

Blue Evolution
MARMO E PIETRA

20 mm **OUTDOOR R11C**



80x80
31 1/2"x31 1/2"
Nat Ret

Sviluppo grafico per formato
Pattern by size
Développement graphique par format
Grafischer Entwurf für Format



80x80
20 mm

19

ANTHRACITE 80x80 20 mm OUTDOOR R11C



20 mm
R11C

80x80
31 1/2"x31 1/2"

Nat Ret

BLACK	092044
ANTHRACITE	092042
GREY	092040
Price code	M137

Pezzi Speciali / Trims. Pièces speciale. Die Sonderstücke

20 mm
R11C

	40x80		40x80		20x80	20x80
	Costa toro Nat Ret	Costa retta Nat Ret	Costa toro Nat Ret	Costa retta Nat Ret		
BLACK	092256	092259	092387SX 092262 DX	092265 SX 092383 DX	092367	092373 SX 092370 DX
ANTHRACITE	092255	092258	092386 SX 092261 DX	092264 SX 092346 DX	092366	092372 SX 092369 DX
GREY	092384	092344	092385 SX 092260 DX	092263 SX 092345 DX	092365	092371 SX 092368 DX
Price code	P181	P175	P203	P197	P239	P239

La gamma completa dei pezzi speciali è disponibile nella "PARTE TECNICA" del catalogo a pag. 493

Our entire range of trims is available in our "TECHNICAL SECTION" of this catalogue pag. 493.

La gamme complète des pièces spéciales est disponible dans la section "PARTIE TECHNIQUE" à la pag. 493 de ce catalogue.

Das komplette Sortiment an Sonderstücken ist in dem "technischen Teil" des Katalogs auf Seite 493 verfügbar.

Imballi / Packings. Emballage. Verpackung

	PCS/BOX	MQ/BOX	KG/BOX	BOX/PAL	MQ/PAL	KG/PAL	PACKING	PACKING SIZE
20 mm 80 x 80	1	0,64	27,78	40	25,60	1.133	EPAL	80 x 120 x 95h



PEZZI SPECIALI. TRIMS	PCS/BOX	MQ/BOX	KG/BOX	PACKING	PACKING SIZE
20 mm GRIGLIA 20 x 80 **	1	-	8,00	EPAL	80 x 120
GRIGLIA 20 x 80 SX/DX **	1	-	7,50	EPAL	80 x 120
GRADONE 40 x 80 **	1	-	12,50	EPAL	80 x 120
GRADONE 40 x 80 SX/DX **	1	-	12,50	EPAL	80 x 120

**** A disposizione solo su richiesta. Tempi di consegna: 30gg**

Available upon request only. Delivery terms: 30 days

Disponible seulement sur requête. Délais de livraison: 30 jours

Verfügbar auf Anfrage. Lieferzeit: 30 Tage

La gamma completa dei pezzi speciali è disponibile nella "PARTE TECNICA" del catalogo a pag. 493

Our entire range of trims is available in our "TECHNICAL SECTION" of this catalogue pag. 493.

La gamme complète des pièces spéciales est disponible dans la section "PARTIE TECHNIQUE" à la pag. 493 de ce catalogue.

Das komplette Sortiment an Sonderstücken ist in dem "technischen Teil" des Katalogs auf Seite 493 verfügbar.

*I Qua
rzi*

ANTRACITE

PRASIO

DIASPRO

MADERA

V2
SHADE SPECTRUM
MODERATE
Antracite

V3
SHADE SPECTRUM
HIGH
Prasio, Diaspro, Madera

ANSI A - 326.3: 2021
WET DYNAMIC COEFFICIENT OF FRICTION | DCOF ≥ 0,42
ISO 13006 - G - Bla_E ≤ 0,5% - UNI EN 14411 - UGL

100 % DESIGN AND
PRODUCTION OF ITALY

I Quarzi
MARMO E PIETRA

8,8 mm R10A



60x60
24"x24"
Nat Ret



30x60
12"x24"
Nat Ret



30x30
12"x12"
Nat Ret



30,5x60,5
12"x24"
Nat

modular system

Decori / Decors



Mosaico 30x30
12"x12"
Nat Ret



Muretto 15x60
6"x24"
Nat Ret

8,8 mm OUTDOOR R11C



60x60
24"x24"
Nat Ret



30x60
12"x24"
Nat Ret



30x30
12"x12"
Nat Ret



30,5x60,5
12"x24"
Nat



20,3x40,6
8"x16"
Nat

modular system

20 mm OUTDOOR R11C



60x60
24"x24"
Nat Ret

Sviluppo grafico per formato
Pattern by size
Développement graphique par format
Grafischer Entwurf für Format



60x60
8,8 mm
14

30x60
8,8 mm
46

30,5x60,5
8,8 mm
46

30x30
8,8 mm
56

20,3x40,6
8,8 mm
46

60x60
20 mm
14

Sviluppo Grafico

Pattern by size. Développement graphique par format. Grafischer Entwurf für Format

PRASIO 60x60 8,8 mm



14 patterns



Wall
Ardesia Muretto 3D Cenere 15x61_6'x24" Nat

Floor
Prasio 60x60_24"x24" - 30x60_12"x24" - 30x30_12"x12" Nat Ret

I Quarzi

8,8 mm
R 10A

	60x60 24"x24"	30x60 12"x24"	30,5x60,5 12"x24"	30x30 12"x12"
	Nat Ret	Nat Ret	Nat	Nat Ret
ANTRACITE	662RI4	V62RI4	V62NI4	962RI4
PRASIO	662RI3	V62RI3	V62NI3	962RI3
DIASPRO	662RI1	V62RI1	V62NI1	962RI1
MADERA	662RI2	V62RI2	V62NI2	962RI2
Price code	M089	M089	M073	M111

8,8 mm
R 10A

	Mosaico 30x30 12"x12"	Muretto 15x60 6"x24"
	Nat Ret	Nat Ret
ANTRACITE	962RI9	L62RI8
PRASIO	962RI8	L62RI7
DIASPRO	962RI6	L62RI5
MADERA	962RI7	L62RI6
Price code	M159	M185

8,8 mm
R 11C

	60x60 24"x24"	30x60 12"x24"	30,5x60,5 12"x24"	30x30 12"x12"	20,3x40,6 8"x16"
	Nat Ret	Nat Ret	Nat	Nat Ret	Nat
ANTRACITE	662RE4	V62RE4	V62NE4	962RE4	-
PRASIO	662RE3	V62RE3	V62NE3	962RE3	242NE3
DIASPRO	662RE1	V62RE1	V62NE1	962RE1	242NE1
MADERA	662RE2	V62RE2	V62NE2	962RE2	242NE2
Price code	M089	M089	M073	M111	M083

20 mm
R 11C

	60x60 24"x24"
	Nat Ret
ANTRACITE	662RE8
PRASIO	662RE7
DIASPRO	662RE5
MADERA	662RE6
Price code	M117

20 mm
R 11C

	30x60		30x60	
	Costa toro Nat Ret	Costa retta Nat Ret	Costa toro Nat Ret	Costa retta Nat Ret
ANTRACITE	062154	062150	062172 SX 062163 DX	062168 SX 062159 DX
PRASIO	062153	062149	062171 SX 062162 DX	062167 SX 062158 DX
DIASPRO	062151	062147	062169 SX 062160 DX	062165 SX 062156 DX
MADERA	062152	062148	062170 SX 062161 DX	062166 SX 062157 DX
Price code	P135	P135	P151	P145

20 mm
R 11C

	15x60		30x60	
ANTRACITE	062246	062231	062256 SX 062251 DX	062241 SX 062236 DX
PRASIO	062245	062230	062255 SX 062250 DX	062240 SX 062235 DX
DIASPRO	062243	062228	062253 SX 062248 DX	062238 SX 062233 DX
MADERA	062244	062229	062254 SX 062249 DX	062239 SX 062234 DX
Price code	P195	P217	P195	P217

Pezzi Speciali / Trims. Pièces speciale. Die Sonderstücke

8,8 mm
R 10A

	Battiscopa Skirting	Gradino costa retta** Straight-edge stair**	Gradino costa retta SX - DX** Straight-edge step L-R
	9,5x60	33x60	33x60
	Nat Ret	Nat Ret	Nat Ret
ANTRACITE	B62RI4	K62RI8	J62RS8 SX J62RD8 DX
PRASIO	B62RI3	K62RI7	J62RS7 SX J62RD7 DX
DIASPRO	B62RI1	K62RI5	J62RS5 SX J62RD5 DX
MADERA	B62RI2	K62RI6	J62RS6 SX J62RD6 DX
Price code	P021	P141	P169

8,8 mm
R 11C

	Gradino costa retta** Straight-edge stair**	Gradino costa retta SX - DX** Straight-edge step L-R	Elle monolitico estruso** Extruded L-shaped monoblock tile
	33x60	33x60	15x30x4
	Nat Ret	Nat Ret	Nat
ANTRACITE	K62RE8	J62RE8S SX J62RE8D DX	062278
PRASIO	K62RE7	J62RE7S SX J62RE7D DX	062277
DIASPRO	K62RE5	J62RE5S SX J62RE5D DX	062275
MADERA	K62RE6	J62RE6S SX J62RE6D DX	062276
Price code	P141	P169	P044

Imballi / Packings. Emballage. Verpackung

	PCS/BOX	MQ/BOX	KG/BOX	BOX/PAL	MQ/PAL	KG/PAL	PACKING	PACKING SIZE
8,8 mm								
60 x 60	3	1,08	23,33	40	43,20	950	EPAL	80 x 120 x 75h
30 x 60	7	1,26	24,00	48	60,48	1.174	EPAL	80 x 120 x 75h
30,5 x 60,5	7	1,29	23,98	40	51,60	981	EPAL	80 x 120 x 76h
30 x 30	12	1,08	22,30	40	43,20	914	EPAL	80 x 120 x 75h
20,3 x 40,6	13	1,07	20,33	72	77,04	1.485	EPAL	80 x 120 x 96h
DECORI. DECORS								
MOSAICO 30x30	6	0,54	13,00	54	29,16	722	EPAL	80 x 120 x 75h
MURETTO 15x60	3	0,27	6,00	98	26,46	612	EPAL	80 x 120 x 70h
20 mm								
60 x 60	2	0,72	32	32	23,04	1.046	EPAL	80 x 120 x 75h

PEZZI SPECIALI. TRIMS

	PCS/BOX	MQ/BOX	KG/BOX	PACKING	PACKING SIZE
8,8 mm					
BATTISCOPA 9,5 x 60	12	-	15,00	EPAL	80 x 120
GRADINO COSTA RETTA 33 x 60 x 3,2h **	4	-	23,00	EPAL	80 x 120
GRADINO COSTA RETTA 33 x 60 x 3,2h R11 **	4	-	23,00	EPAL	80 x 120
GRADINO COSTA RETTA 33 x 60 x 3,2h SX/DX **	4	-	24,00	EPAL	80 x 120
GRADINO COSTA RETTA 33 x 60 x 3,2h SX/DX R11 **	4	-	24,00	EPAL	80 x 120
ELLE MONOLITICO ESTRUSO 15 x 30 x 4H **	8	-	10,40	EPAL	80 x 120
20 mm					
GRADONE 15 x 60 **	1	-	4,50	EPAL	80 x 120
GRADONE 15 x 60 SX/DX **	1	-	3,80	EPAL	80 x 120
GRADONE 30 x 60 **	1	-	9,00	EPAL	80 x 120
GRADONE 30 x 60 SX/DX **	1	-	6,60	EPAL	80 x 120
GRIGLIA 15 x 60 **	1	-	4,20	EPAL	80 x 120
GRIGLIA 15 x 60 SX/DX **	1	-	3,60	EPAL	80 x 120
GRIGLIA 30 x 60 **	1	-	8,40	EPAL	80 x 120
GRIGLIA 30 x 60 SX/DX **	1	-	7,20	EPAL	80 x 120

La gamma completa dei pezzi speciali è disponibile nella "PARTE TECNICA" del catalogo a pag. 493
Our entire range of trims is available in our "TECHNICAL SECTION" of this catalogue pag. 493.
La gamme complète des pièces spéciales est disponible dans la section "PARTIE TECHNIQUE" à la pag. 493 de ce catalogue.
Das komplette Sortiment an Sonderstücken ist in dem "technischen Teil" des Katalogs auf Seite 493 verfügbar.

La gamma completa dei pezzi speciali è disponibile nella "PARTE TECNICA" del catalogo a pag. 493
Our entire range of trims is available in our "TECHNICAL SECTION" of this catalogue pag. 493.
La gamme complète des pièces spéciales est disponible dans la section "PARTIE TECHNIQUE" à la pag. 493 de ce catalogue.
Das komplette Sortiment an Sonderstücken ist in dem "technischen Teil" des Katalogs auf Seite 493 verfügbar.





Borghi Italiani
MARMO E PIETRA

*Borghi
Italiani*

GRAFITE

AGATA

CENERE

SILICE

CALCE

V3
SHADE SPECTRUM
HIGH

ISO 13006 - G - Bla_E ≤ 0,5% - UNI EN 14411 - GL
ANSI A - 326.3: 2021
WET DYNAMIC COEFFICIENT OF FRICTION | DCOF ≥ 0,42

100 % DESIGN AND
PRODUCTION OF ITALY

Borghesi Italiani
MARMO E PIETRA

8,8 mm OUTDOOR R11C



40,6x60,9
16"x24"
Nat



40,6x40,6
16"x16"
Nat



20,3x40,6
8"x16"
Nat



20,3x20,3
8"x8"
Nat

modular system

Sviluppo grafico per formato
Pattern by size
Développement graphique par format
Grafischer Entwurf für Format



40,6x60,9
8,8 mm

15

40,6x40,6
8,8 mm

27

20,3x40,6
8,8 mm

60

20,3x20,3
8,8 mm

56

Sviluppo Grafico e Modularità

Pattern by size and modular system. Développement graphique par format et système modulaire. Grafische Entwicklung und Modularität.

AGATA 8,8 mm



40,6x60,9
16"x24"
33,5%

40,6x40,6
16"x16"
44,5%

20,3x40,6
8"x16"
11%

20,3x20,3
8"x8"
11%

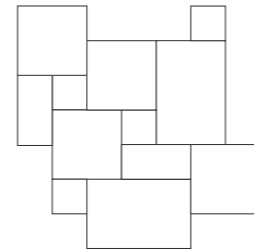

8,8 mm
R11C

	40,6x60,9 16"x24"	40,6x40,6 16"x16"	20,3x40,6 8"x16"	20,3x20,3 8"x8"
	Nat	Nat	Nat	Nat
GRAFITE	162014	162024	162034	162044
AGATA	162012	162022	162032	162042
CENERE	162011	162021	162031	162041
SILICE	162013	162023	162033	162043
CALCE	162010	162020	162030	162040
Price code	M083	M083	M083	M083

Pezzi Speciali / Trims. Pièces speciale. Die Sonderstücke

	Battiscopa Skirting	Gradino costa retta** Straight-edge stair**	Gradino costa retta SX - DX** Straight-edge step L-R	Elle monolitico estruso** Extruded L-shaped monoblock tile
	7x60,9	33x60,9	33x60,9	15x30x4
	Nat	Nat	Nat	Nat
GRAFITE	162105	162205	162225 SX 162215 DX	162415
AGATA	162103	162203	162223 SX 162213 DX	162413
CENERE	162102	162202	162222 SX 162212 DX	162412
SILICE	162104	162204	162224 SX 162214 DX	162414
CALCE	162101	162201	162221 SX 162211 DX	162411
Price code	P021	P135	P167	P050

Imballi / Packings. Emballage. Verpackung

	PCS/BOX	MQ/BOX	KG/BOX	BOX/PAL	MQ/PAL	KG/PAL	PACKING	PACKING SIZE
8,8 mm								
40,6 x 60,9	6	1,48	31,60	40	59,20	1.266	EPAL	80 x 120 x 96h
40,6 x 40,6	6	0,99	21,63	72	71,28	1.560	EPAL	80 x 120 x 96h
20,3 x 40,6	13	1,07	22,38	72	77,04	1.686	EPAL	80 x 120 x 96h
20,3 x 20,3	30	1,24	27,09	60	74,40	1.628	EPAL	80 x 120 x 96h

PEZZI SPECIALI. TRIMS	PCS/BOX	MQ/BOX	KG/BOX	BOX/PAL	MQ/PAL	KG/PAL	PACKING	PACKING SIZE
8,8 mm								
BATTISCOPA 7 x 60,9	15	0,63	13,76	-	-	-	EPAL	80 x 120
GRADINO COSTA RETTA 33 x 60,9 x 3,2h **	4	-	20	-	-	-	EPAL	80 x 120
GRADINO COSTA RETTA 33 x 60,9 x 3,2h SX/DX **	2	-	11	-	-	-	EPAL	80 x 120
ELLE MONOLITICO ESTRUSO 15 x 30 x 4h **	8	0,32	8,20	36	11,52	298	EPAL	80 x 120 x 75h



** A disposizione solo su richiesta.
Tempi di consegna: 30gg
Available upon request only.
Delivery terms: 30 days
Disponible seulement sur requête.
Délais de livraison: 30 jours
Verfügbar auf Anfrage.
Lieferzeit: 30 Tage

materico

Metal	271
Absolute	279
Skyline	285
Hurban	293
Le Malte	301
Space	309
Agglomerate	317
Artile	325
Lascaux	333
Cotto del Casale	339
Up	347
Small	357



Metal

MATERICO

Metal

BLADE

GREIGE

PEARL

CORTEN

V2
SHADE SPECTRUM
MODERATE

ISO 13006 - G - Bla_E ≤ 0,5% - UNI EN 14411 - UGL
ANSI A - 326.3: 2021
WET DYNAMIC COEFFICIENT OF FRICTION | DCOF ≥ 0,42

100 % DESIGN AND
PRODUCTION OF ITALY

Metal
MATERICO

6 mm



160x320
63"x126"
Nat Ret



120x280
48"x110"
Nat Ret

Decoro / Decor



Mosaico 30x30
12"x12"
Nat Ret

8,8 mm



60x120
24"x48"
Nat Ret

Sviluppo grafico per formato
Pattern by size
Développement graphique par format
Grafischer Entwurf für Format



160x320
6 mm

7

120x280
6 mm

11

60x120
8,8 mm

16

Sviluppo Grafico

Pattern by size. Développement graphique par format. Grafischer Entwurf für Format

CORTEN 160x320 6 mm



7 patterns







Wall
Corten 160x320_63"x126" 6mm





Floor
Hurban Beige 100x100_40"x40" Nat Ret

Metal

6 mm





	160x320 63"x126"	120x280 48"x110"	Mosaico 30x30 12"x12"
	Nat Ret	Nat Ret	Nat Ret
BLADE 	140004	140024	140304
GREIGE 	140002	140022	140302
PEARL 	140001	140021	140301
CORTEN 	140003	140023	140303
Price code	M173	M153	M193

8,8 mm

	60x120 24"x48"
	Nat Ret
BLADE 	140124
GREIGE 	140122
PEARL 	140121
CORTEN 	140123
Price code	M109

Pezzi Speciali / Trims. Pièces speciale. Die Sonderstücke

8,8 mm

	Battiscopa Skirting 6,5x120	Gradino costa retta** Straight-edge stair** 33x120	Gradino costa retta SX - DX** Straight-edge step L-R corner** 33x120
	Nat Ret	Nat Ret	Nat Ret
BLADE 	140204	140372	140388 SX 140380 DX
GREIGE 	140202	140370	140386 SX 140378 DX
PEARL 	140201	140369	140385 SX 140377 DX
CORTEN 	140203	140371	140387 SX 140379 DX
Price code	P040	P207	P231



Wall
Metal Blade 160x320_63"x126" Nat Ret

Floor
Ca' Foscari Tabacco Chevron 40,7x7,5_16"x3" Nat

Imballi / Packings. Emballage. Verpackung

	PCS/BOX	MQ/BOX	KG/BOX	PCS/PAL	BOX/PAL	MQ/PAL	KG/PAL	PACKING	PACKING SIZE	TARE (KG)
6 mm										
160 x 320	-	-	-	14	-	71,68	1178	CASSA	345 x 175 x 37h	140
	-	-	-	44	-	225,28	3.440	CAVALLETTO LEGNO	330 x 75 x 193,5h	177,50
120 x 280	-	-	-	20	-	67,20	1081	CASSA	292 x 145 x 35h	108
	-	-	-	44	-	147,84	2.285	CAVALLETTO LEGNO	290 x 75 x 161h	145
MOSAICO 30 x 30	9	0,81	11,90	-	60	48,60	716	EPAL	80 x 120	22
8,8 mm										
60 x 120	2	1,44	27,9	-	32	46,08	895	EPAL	80 x 120	22



Cavalletto in legno
Wood A-Frame. Support en bois.
Holzgestell



Cassa
Crate. Caisse. Kiste



Epal / Pallet

PEZZI SPECIALI. TRIMS.	PCS/BOX	MQ/BOX	KG/BOX	PACKING	PACKING SIZE
8,8 mm					
BATTISCOPA 6,5 x 120	6	-	11,40	PALLET	80 x 120
GRADINO COSTA RETTA 33 x 120 x 3,2h **	2	-	22	PALLET	80 x 120
GRADINO COSTA RETTA 33 x 120 x 3,2h SX/DX **	1	-	11	PALLET	80 x 120

**** A disposizione solo su richiesta. Tempi di consegna: 30gg**
Available upon request only. Delivery terms: 30 days
Disponible seulement sur requête. Délais de livraison: 30 jours
Verfügbar auf Anfrage. Lieferzeit: 30 Tage

Abso lute



Absolute

MATERICO

BLACK

WHITE



ISO 13006 - G - Bla_E ≤ 0,5% - UNI EN 14411 - UGL
ANSI A - 326.3: 2021
WET DYNAMIC COEFFICIENT OF FRICTION



Absolute
MATERICO

6 mm



160x320
63"x126"
Nat Ret
Lap Ret

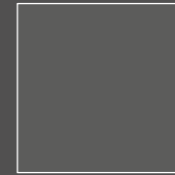

160x160
63"x63"
Nat Ret
Lap Ret



80x160
31 1/2"x63"
Nat Ret
Lap Ret



80x80
31 1/2"x31 1/2"
Nat Ret
Lap Ret



120x280
48"x110"
Nat Ret
Lap Ret



120x120
48"x48"
Nat Ret
Lap Ret

modular system

Decoro / Decor



Mosaico 30x30
12"x12"
Nat Ret
Lap Ret

8,8 mm



60x120
24"x48"
Nat Ret



60x60
24"x24"
Nat Ret

modular system

Sviluppo grafico per formato
Pattern by size
Développement graphique par format
Grafischer Entwurf für Format



160x320
6 mm
1

160x160
6 mm
1

80x160
6 mm
1

80x80
6 mm
1

120x280
6 mm
1

120x120
6 mm
1

60x120
8,8 mm
1

60x60
8,8 mm
1

Absolute

6 mm

	160x320 63"x126"		160x160 63"x63"		80x160 31 1/2"x63"		80x80 31 1/2"x31 1/2"		120x280 48"x110"		120x120 48"x48"		Mosaico 30x30 12"x12"	
	Nat Ret	Lap Ret	Nat Ret	Lap Ret	Nat Ret	Lap Ret	Nat Ret	Lap Ret	Nat Ret	Lap Ret	Nat Ret	Lap Ret	Nat Ret	Lap Ret
BLACK	097005	097004	097035	097034	097056	097055	097066	097065	097015	097014	097045	097044	097123	097122
WHITE	097002	097001	097032	097031	097052	097051	097062	097061	097012	097011	097042	097041	097121	097120
Price code	M181	M205	M169	M193	M155	M179	M133	M148	M163	M185	M151	M177	M193	M235

8,8 mm

	60x120 24"x48"	60x60 24"x24"
	Nat Ret	Nat Ret
BLACK	097085	097095
WHITE	097081	097091
Price code	M121	M109



Furniture
Absolute Black Nat

Floor
Absolute White 120x120_48"x48" Nat Ret

Pezzi Speciali / Trims. Pièces speciale. Die Sonderstücke

6 mm

	8x80		33x160		33x120		33x160		33x120	
	Nat Ret	Lap Ret	Nat Ret	Lap Ret	Nat Ret	Lap Ret	Nat Ret	Lap Ret	Nat Ret	Lap Ret
BLACK	097119	097118	097224	097222	097228	097226	097218 SX 097220 DX	097214 SX 097216 DX	097266 SX 097264 DX	097250 SX 097230 DX
WHITE	097116	097115	097223	097221	097227	097225	097217 SX 097219 DX	097210 SX 097215 DX	097265 SX 097263 DX	097249 SX 097229 DX
Price code	P029	P039	P303	P323	P243	P265	P319	P339	P273	P283

8,8 mm

	6,5x120	33x120	33x120
	Nat Ret	Nat Ret	Nat Ret
BLACK	097111	097268	097272 SX 097270 DX
WHITE	097110	097267	097271 SX 097269 DX
Price code	P040	P207	P231

Imballi / Packings. Emballage. Verpackung

	PCS/BOX	MQ/BOX	KG/BOX	PCS/PAL	BOX/PAL	MQ/PAL	KG/PAL	PACKING	PACKING SIZE	TARE (KG)
6 mm										
160 x 320	-	-	-	14	-	71,68	1.178	CASSA	345 x 175 x 37h	140
	-	-	-	44	-	225,28	3.440	CAVALLETTO LEGNO	330 x 75 x 193,5h	177,50
160 x 160	-	-	-	24	-	61,44	970	CASSA	182,6 x 173,6 x 40,4h	80
80 x 160	2	2,56	37,20	-	15	38,40	632	PALLET SPECIALE	168 x 97 x 40,9h	29,4
80 x 80	3	1,92	27,90	-	40	76,80	1.143	EPAL	80 x 120	22
120 x 280	-	-	-	20	-	67,20	1.081	CASSA	292 x 145 x 35h	108
	-	-	-	44	-	147,84	2.285	CAVALLETTO LEGNO	290 x 75 x 161h	145
120 x 120	2	2,88	41,70	-	24	69,12	1.041	PALLET SPECIALE	123 x 143 x 74h	29
MOSAICO 30 x 30	9	0,81	11,90	-	60	48,60	716	EPAL	80 x 120	22
8,8 mm										
60 x 120	2	1,44	27,9	-	32	46,08	895	EPAL	80 x 120	22
60 x 60	3	1,08	21	-	40	43,20	842	EPAL	80 x 120	22



Cavalletto in legno
Wood A-Frame. Support en bois.
Holzgestell



Cassa
Crate. Caisse. Kiste



Pallet speciale con sponde
Special pallet with sides.
Palette spéciale avec bords.
Spezial-Palette mit Wandungen.



Epal / Pallet

PEZZI SPECIALI. TRIMS.	PCS/BOX	MQ/BOX	KG/BOX	PACKING	PACKING SIZE
6 mm					
BATTISCOPIA 6 x 80	12	0,77	11,50	PALLET	80 x 120
GRADINO COSTA RETTA 33 x 160 x 3,2h **	1	-	9	PALLET SPECIALE	168 x 97 x 40,9h
GRADINO COSTA RETTA 33 x 160 x 3,2h SX/DX **	1	-	10	PALLET SPECIALE	168 x 97 x 40,9h
GRADINO COSTA RETTA 33 x 120 x 3,2h **	2	-	14	PALLET	80 x 120
GRADINO COSTA RETTA 33 x 120 x 3,2h SX/DX **	1	-	7	PALLET	80 x 120
8,8 mm					
BATTISCOPIA 6,5 x 120	6	-	11,40	PALLET	80 x 120
GRADINO COSTA RETTA 33 x 120 x 3,2h **	2	-	22	PALLET	80 x 120
GRADINO COSTA RETTA 33 x 120 x 3,2h SX/DX **	1	-	11	PALLET	80 x 120

** A disposizione solo su richiesta. Tempi di consegna: 30gg
Available upon request only. Delivery terms: 30 days
Disponibile seulement sur requête. Délais de livraison: 30 jours
Verfügbar auf Anfrage. Lieferzeit: 30 Tage

Skyline

MATERICO

*Sky
line*

ANTRACITE

FUMO

GHIACCIO

BEIGE



ISO 13006 - G - Bla_E ≤ 0,5% - UNI EN 14411 - UGL
ANSI A - 326.3: 2021
WET DYNAMIC COEFFICIENT OF FRICTION | DCOF ≥ 0,42



Skyline
MATERICO

6 mm

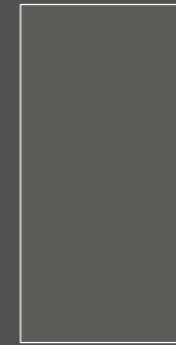

160x320
63"x126"
Nat Ret



160x160
63"x63"
Nat Ret



80x160
31 1/2"x63"
Nat Ret



80x80
31 1/2"x31 1/2"
Nat Ret



120x280
48"x110"
Nat Ret



120x120
48"x48"
Nat Ret

modular system

modular system

Decoro / Decor



Mosaico 30x30
12"x12"
Nat Ret

8,8 mm



100x100
40"x40"
Nat Ret



60x120
24"x48"
Nat Ret



60x60
24"x24"
Nat Ret

modular system

8,8 mm **OUTDOOR R11C**



100x100
40"x40"
Nat Ret

20 mm **OUTDOOR R11C**



100x100
40"x40"
Nat Ret

Sviluppo grafico per formato
Pattern by size
Développement graphique par format
Grafischer Entwurf für Format



160x320 6 mm	160x160 6 mm	80x160 6 mm	80x80 6 mm	120x280 6 mm	120x120 6 mm	100x100 8,8 mm 20 mm	60x120 8,8 mm	60x60 8,8 mm
7	14	28	56	11	22	14	23	56

GHIACCIO 160x320 6 mm

7 patterns

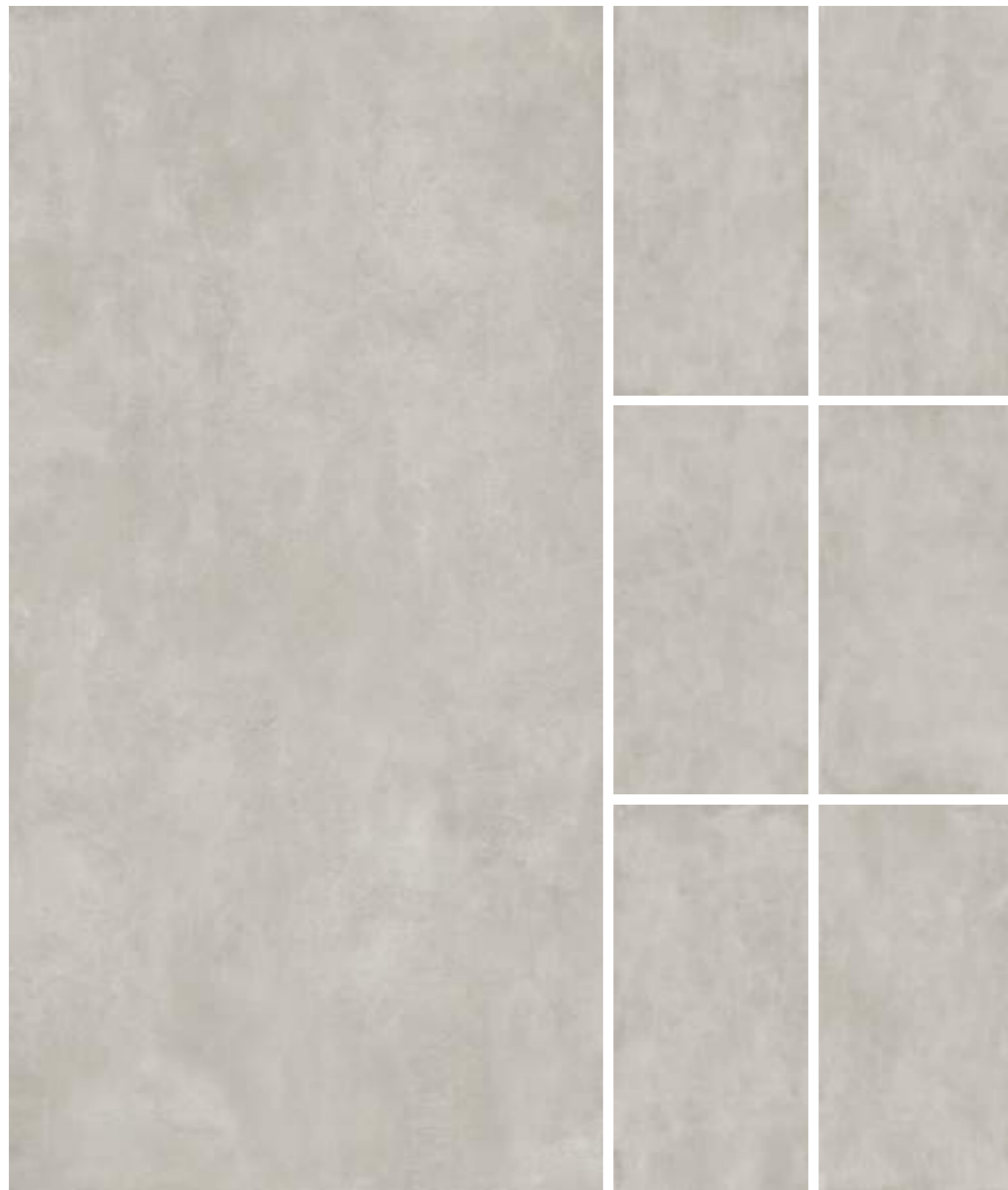

	160x320 63"x126"		160x160 63"x63"		80x160 31 1/2"x63"		80x80 31 1/2"x31 1/2"		120x280 48"x110"		120x120 48"x48"		Mosaico 30x30 12"x12"	
	Nat Ret		Nat Ret		Nat Ret		Nat Ret		Nat Ret		Nat Ret		Nat Ret	
ANTRACITE	082010	082050	082090	082110	082040	082070	082189							
FUMO	082007	082047	082087	082107	082037	082067	082185							
GHIACCIO	082001	082041	082081	082101	082031	082061	082181							
BEIGE	082004	082044	082084	082104	082034	082064	082183							
Price code	M173	M161	M141	M129	M153	M141	M193							

	8,8 mm			8,8 mm R11C		20 mm R11C	
	Nat Ret			Nat Ret		Nat Ret	
ANTRACITE	082094	082130	082150	082098	082114		
FUMO	082091	082127	082147	082095	082111		
GHIACCIO	082093	082121	082141	082097	082113		
BEIGE	082092	082124	082144	082096	082112		
Price code	M109	M109	M089	M109	M143		

Imballi / Packings. Emballage. Verpackung

	PCS/BOX	MQ/BOX	KG/BOX	PCS/PAL	BOX/PAL	MQ/PAL	KG/PAL	PACKING	PACKING SIZE	TARE (KG)
6 mm										
160 x 320	-	-	-	14	-	71,68	1.178	CASSA	345 x 175 x 37h	140
	-	-	-	44	-	225,28	3.440	CAVALLETTO LEGNO	330 x 75 x 193,5h	177,50
160 x 160	-	-	-	24	-	61,44	970	CASSA	182,6 x 173,6 x 40,4h	80
80 x 160	2	2,56	37,20	-	15	38,40	632	PALLET SPECIALE	168 x 97 x 40,9h	29,4
80 x 80	3	1,92	27,90	-	40	76,80	1.143	EPAL	80 x 120	22
120 x 280	-	-	-	20	-	67,20	1.081	CASSA	292 x 145 x 35h	108
	-	-	-	44	-	147,84	2.285	CAVALLETTO LEGNO	290 x 75 x 161h	145
120 x 120	2	2,88	41,70	-	24	69,12	1.041	PALLET SPECIALE	123x 143 x 74h	29
MOSAICO 30 x 30	9	0,81	11,90	-	60	48,60	716	EPAL	80 x 120	22
8,8 mm										
60 x 120	2	1,44	27,9	-	32	46,08	895	EPAL	80 x 120	22
60 x 60	3	1,08	21	-	40	43,20	842	EPAL	80 x 120	22
100 x 100	2	2	40	-	24	48	990	PALLET SPECIALE	103 x 123 x 70h	30
20 mm										
100 x 100	1	1	39,85	-	24	24	982	PALLET	103 x 103 x 65h	22



Cavalletto in legno
Wood A-Frame. Support en bois.
Holzgestell



Cassa
Crate. Caisse. Kiste



Pallet speciale con sponde
Special pallet with sides.
Palette spéciale avec bords.
Spezial-Palette mit Wandungen.



Epal / Pallet

Pezzi Speciali / Trims. Pièces speciale. Die Sonderstücke

6 mm



Battiscopa
Skirting

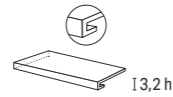

Gradino costa retta**
Straight-edge stair**

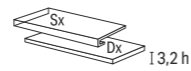

Gradino costa retta SX - DX**
Straight-edge step L-R corner**

	8x80	33x160	33x120	33x160	33x120
	Nat Ret	Nat Ret	Nat Ret	Nat Ret	Nat Ret
ANTRACITE	082204	082244	082252	082308 SX 082276 DX	082316 SX 082284 DX
FUMO	082203	082207	082251	082307 SX 082275 DX	082315 SX 082283 DX
GHIACCIO	082201	082205	082249	082305 SX 082273 DX	082313 SX 082281 DX
BEIGE	082202	082206	082250	082306 SX 082274 DX	082314 SX 082282 DX
Price code	P029	P303	P243	P319	P273

20 mm

R11C



Griglia**
Drainage grid

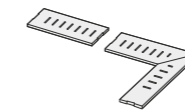

Griglia SX - DX**
Drainage grid L-R corner**

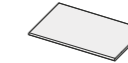

Gradone**
Large step

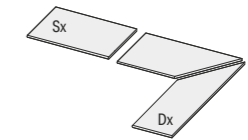

Gradone SX - DX**
Large step L-R corner**

	20x100	20x100	50x100	50x100	50x100	50x100
	Nat Ret	Nat Ret	Nat Ret	Nat Ret	Nat Ret	Nat Ret
ANTRACITE	082664	082672 SX 082668 DX	082616	082604	082624 SX 082620 DX	082612 SX 082608 DX
FUMO	082661	082669 SX 082665 DX	082613	082601	082621 SX 082617 DX	082609 SX 082605 DX
GHIACCIO	082663	082671 SX 082667 DX	082615	082603	082623 SX 082619 DX	082611 SX 082607 DX
BEIGE	082662	082670 SX 082666 DX	082614	082602	082622 SX 082618 DX	082610 SX 082606 DX
Price code	P291	P291	P235	P225	P253	P245



Costa toro.
Bullnose edge.
Bord boudin.
Abgerundete Kante.



Costa retta.
Straight edge.
Bord droit.
Gerade Kante.

8,8 mm



Battiscopa
Skirting

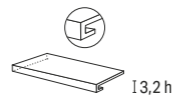

Gradino costa retta**
Straight-edge stair**

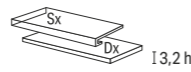

Gradino costa retta SX - DX**
Straight-edge step L-R corner**

	6,5x120	7x100	33x120	33x100	33x120	33x100
	Nat Ret	Nat Ret	Nat Ret	Nat Ret	Nat Ret	Nat Ret
ANTRACITE	082212	082120	082268	082248	082332 SX 082300 DX	082312 SX 082280 DX
FUMO	082211	082117	082267	082245	082331 SX 082299 DX	082309 SX 082277 DX
GHIACCIO	082209	082119	082265	082247	082329 SX 082297 DX	082311 SX 082279 DX
BEIGE	082210	082118	082266	082246	082330 SX 082298 DX	082310 SX 082278 DX
Price code	P040	P035	P207	P207	P231	P219

8,8 mm

R11C

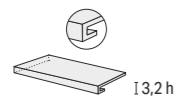

Gradino costa retta**
Straight-edge stair**

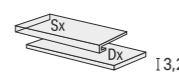

Gradino costa retta SX - DX**
Straight-edge step L-R corner**

	33x100	33x100
	Nat Ret	Nat Ret
ANTRACITE	082256	082320 SX 082288 DX
FUMO	082253	082317 SX 082285 DX
GHIACCIO	082255	082319 SX 082287 DX
BEIGE	082254	082318 SX 082286 DX
Price code	P207	P219

Imballi / Packings. Emballage. Verpackung

PEZZI SPECIALI. TRIMS.	PCS/BOX	MQ/BOX	KG/BOX	PACKING	PACKING SIZE
6 mm					
BATTISCOPIA 8 x 80	12	0,77	11,50	PALLET	80 x 120
GRADINO COSTA RETTA 33 x 160 x 3,2h **	1	-	9	PALLET SPECIALE	168 x 97 x 40,9h
GRADINO COSTA RETTA 33 x 160 x 3,2h SX/DX **	1	-	10	PALLET SPECIALE	168 x 97 x 40,9h
GRADINO COSTA RETTA 33 x 120 x 3,2h **	2	-	14	PALLET	80 x 120
GRADINO COSTA RETTA 33 x 120 x 3,2h SX/DX **	1	-	7	PALLET	80 x 120
8,8 mm					
BATTISCOPIA 6,5 x 120	6	-	11,40	PALLET	80 x 120
BATTISCOPIA 7 x 100	6	-	9	PALLET	103 x 103
GRADINO COSTA RETTA 33 x 120 x 3,2h **	2	-	22	PALLET	80 x 120
GRADINO COSTA RETTA 33 x 120 x 3,2h SX/DX **	1	-	11	PALLET	80 x 120
GRADINO COSTA RETTA 33 x 100 x 3,2h **	2	-	14	PALLET	103 x 103
GRADINO COSTA RETTA 33 x 100 x 3,2h SX/DX **	1	-	9	PALLET	103 x 103
20 mm					
GRADONE 50 x 100 **	1	-	15	PALLET	103 x 103
GRADONE 50 x 100 SX/DX **	1	-	15	PALLET	103 x 103
GRIGLIA 20 x 100 **	1	-	8	PALLET	103 x 103
GRIGLIA 20 x 100 SX/DX **	1	-	8	PALLET	103 x 103



Pallet speciale con sponde
Special pallet with sides.
Palette spéciale avec bords.
Spezial-Palette mit Wandungen.



Pallet

**** A disposizione solo su richiesta. Tempi di consegna: 30gg**
Available upon request only. Delivery terms: 30 days
Disponible seulement sur requête. Délais de livraison: 30 jours
Verfügbar auf Anfrage. Lieferzeit: 30 Tage



Hurban
MATERICO

Hurban

GRAPHITE

GRAY

AVIO

WHITE

BEIGE

OCRA



ISO 13006 - G - Bla_E ≤ 0,5% - UNI EN 14411 - UGL
ANSI A - 326.3: 2021
WET DYNAMIC COEFFICIENT OF FRICTION | DCOF ≥ 0,42



Hurban
MATERICO

6 mm



120x280
48"x110"
Nat Ret



120x120
48"x48"
Nat Ret

Graphite
Gray
White
Beige

8,8 mm R10B

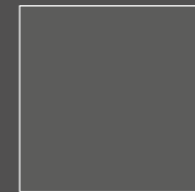

100x100
40"x40"
Nat Ret



60x120
24"x48"
Nat Ret



60x60
24"x24"
Nat Ret



30x60
12"x24"
Nat Ret

modular system

Decori / Decors



Mosaico 30x30
12"x12"
Nat Ret



Spaccatella 30x30
12"x12"
Nat Ret



Quadrotto Intarsio 30x30
12"x12"
Nat Ret

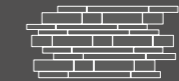

Muretto 30x60
12"x24"
Nat Ret

8,8 mm OUTDOOR R11C

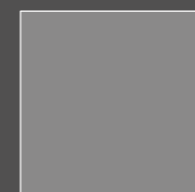

100x100
40"x40"
Nat Ret

Gray
White
Beige

20 mm OUTDOOR R11C

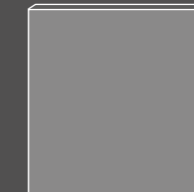

100x100
40"x40"
Nat Ret

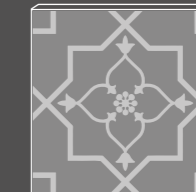

100x100
40"x40"
Nat Ret

Gray
Beige

Sviluppo grafico per formato
Pattern by size
Développement graphique par format
Grafischer Entwurf für Format



120x280
6 mm
4

120x120
6 mm
8

100x100
8,8 mm
10

60x120
8,8 mm
17

60x60
8,8 mm
34

30x60
8,8 mm
68

100x100
20 mm
10

Sviluppo Grafico

Pattern by size. Développement graphique par format. Grafischer Entwurf für Format

WHITE 120x280 6 mm

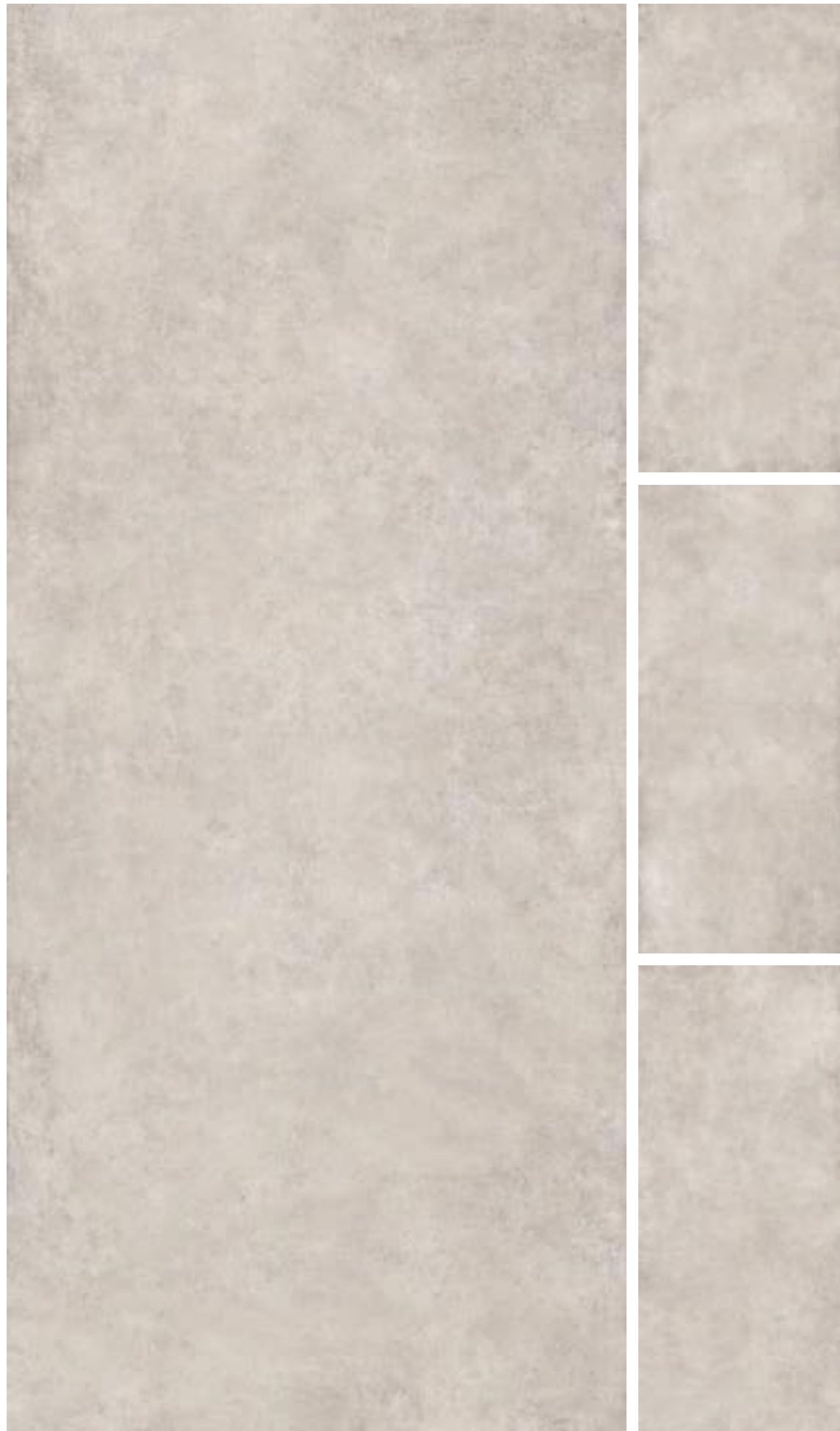

Decorì

Decors

8,8 mm R10B

GRAPHITE

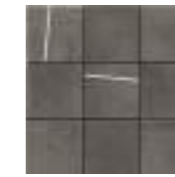

GRAY

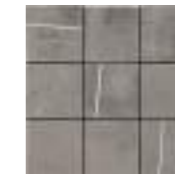

AVIO

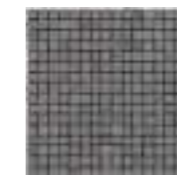

WHITE

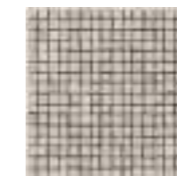
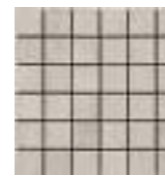

BEIGE

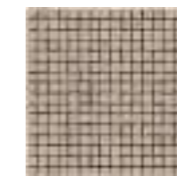

OCRA

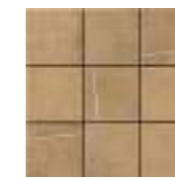

Mosaico 30x30
12"x12"
Nat Ret

Spaccatella 30x30
12"x12"
Nat Ret

Quadrotto Intarsio 30x30
12"x12"
Nat Ret

Muretto 30x60
12"x24"
Nat Ret

20 mm OUTDOOR R11C

BEIGE



Queens 100x100
40"x40"

GRAY





Queens 100x100
40"x40"

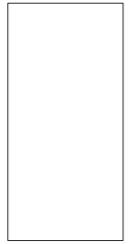

4 patterns

Hurban

6 mm

		
	120x280 48"x110"	120x120 48"x48"
	Nat Ret	Nat Ret
GRAPHITE	177084	177094
GRAY	177083	177093
AVIO	177085	-
WHITE	177081	177091
BEIGE	177082	177092
OCRA	177086	-
Price code	M153	M141

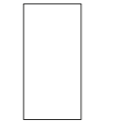
8,8 mm
R10B

				
	100x100 40"x40"	60x120 24"x48"	60x60 24"x24"	30x60 12"x24"
	Nat Ret	Nat Ret	Nat Ret	Nat Ret
GRAPHITE	177054	177004	177014	177024
GRAY	177053	177003	177013	177023
AVIO	177055	177005	177015	177025
WHITE	177051	177001	177011	177021
BEIGE	177052	177002	177012	177022
OCRA	177056	177006	177016	177026
Price code	M109	M097	M089	M081



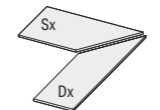

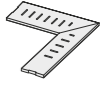

20 mm
R11C

		
	Gradone** Large step	Gradone Angolo Sx/Dx** Large step - Corner L/R
	50x100	50x100
	Costa toro Nat Ret	Costa toro Nat Ret
GRAPHITE	177414	177417 SX 177423 DX
GRAY	177413	177418 SX 177424 DX
AVIO	177415	177419 SX 177425 DX
WHITE	177411	177420 SX 177426 DX
BEIGE	177412	177421 SX 177427 DX
OCRA	177416	177422 SX 177428 DX
Price code	P235	P253

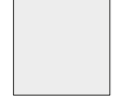
20 mm
R11C

		
	Griglia** Drainage grid	Griglia - Angolo Sx/Dx** Drainage grid - Corner L/R
	20x100	20x100
GRAPHITE	177454	177457 SX 177463 DX
GRAY	177453	177458 SX 177464 DX
AVIO	177455	177459 SX 177465 DX
WHITE	177451	177460 SX 177466 DX
BEIGE	177452	177461 SX 177467 DX
OCRA	177456	177462 SX 177468 DX
Price code	P291	P291

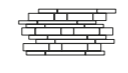
8,8 mm
R11C

						
	100x100 40"x40"	Mosaico 30x30 12"x12"	Spaccatella 30x30 12"x12"	Quadrotto Intarsio 30x30 12"x12"	Muretto 30x60 12"x24"	100x100 40"x40"
	Nat Ret	Nat Ret	Nat Ret	Nat Ret	Nat Ret	Nat Ret
GRAPHITE	-	177304	177314	177324	177334	177064
GRAY	177073	177303	177313	177323	177333	177063
AVIO	-	177305	177315	177325	177335	177065
WHITE	177071	177301	177311	177321	177331	177061
BEIGE	177072	177302	177312	177322	177332	177062
OCRA	-	177306	177316	177326	177336	177066
Price code	M109	M159	M270	M302	M252	M143

La gamma completa dei pezzi speciali è disponibile nella "PARTE TECNICA" del catalogo a pag. 493
Our entire range of trims is available in our "TECHNICAL SECTION" of this catalogue pag. 493.
La gamme complète des pièces spéciales est disponible dans la section "PARTIE TECHNIQUE" à la pag. 493 de ce catalogue.
Das komplette Sortiment an Sonderstücken ist in dem "technischen Teil" des Katalogs auf Seite 493 verfügbar.

Imballi / Packings. Emballage. Verpackung

	PCS/BOX	MQ/BOX	KG/BOX	PCS/PAL	BOX/PAL	MQ/PAL	KG/PAL	PACKING	PACKING SIZE
6 mm									
120 x 280	-	-	-	20	-	67,20	1.081	CASSA	292 x 145 x 35h
	-	-	-	44	-	147,84	2.285	CAVALLETTO LEGNO	290 x 75 x 161h
120 x 120	2	2,88	41,70	-	24	69,12	1.041	PALLET SPECIALE	123x 143 x 74h
8,8 mm									
100 x 100	2	2	36,32	-	24	48	902	PALLET CON SPONDE	103 x 123 x 70h
100 x 100 R11C	2	2	36,32	-	24	48	902	PALLET CON SPONDE	103 x 123 x 70h
60 x 120	2	1,44	29,82	-	32	46,08	976	EPAL	80 x 120 x 75h
60 x 60	3	1,08	25,54	-	40	43,20	1.044	EPAL	80 x 120 x 75h
30 x 60	7	1,26	24	-	-	60,48	1.174	EPAL	80 x 120 x 75h
DECORI. DECORS									
MOSAICO 30 x 30	6	0,54	10,36	60	32,40	644	EPAL	80 x 120	
SPACCATELLA 30 x 30	6	0,54	10,36	60	32,40	644	EPAL	80 x 120	
QUADROTTO INTARSIO 30 x 30	6	0,54	10,36	60	32,40	644	EPAL	80 x 120	
MURETTO 30 x 60	4	0,72	13,71	30	21,60	433	EPAL	80 x 120	
20 mm									
100 x 100 R11C	1	1	39,95	24	24	983	PALLET CON SPONDE	103 x 103 x 65h	
DECORI. DECORS									
QUEENS 100 x 100 R11C	1	1	39,95	24	24	-	PALLET CON SPONDE	103 x 103 x 65h	

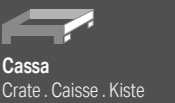

Pezzi Speciali / Trims. Pièces speciale. Die Sonderstücke

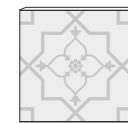

20 mm
R11C



Queens 100x100
40"x40"

	Nat Ret
GRAPHITE	-
GRAY	177403
AVIO	-
WHITE	-
BEIGE	177402
OCRA	-
Price code	M153

8,8 mm
R10B

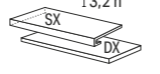
			
	Battiscopa Skirting	Gradino costa retta** Straight nosed stair**	Gradino costa retta SX - DX** Straight-edge step L-R
	7x100	7x60	33x120
	Nat Ret	Nat Ret	Nat Ret
GRAPHITE	177104	177114	177204
GRAY	177103	177113	177203
AVIO	177105	177115	177205
WHITE	177101	177111	177231
BEIGE	177102	177112	177202
OCRA	177106	177116	177206
Price code	P035	P021	P207

PEZZI SPECIALI. TRIMS

	PCS/BOX	MQ/BOX	KG/BOX	PACKING	PACKING SIZE
8,8 mm					
BATTISCOPA 7 x 100	6	0,42	8,10	EPAL	80 x 120
BATTISCOPA 7 x 60	15	0,63	13,28	EPAL	80 x 120
GRADINO COSTA RETTA 33 x 120 x 3,2h**	2	-	20,70	EPAL	80 x 120
GRADINO COSTA RETTA 33 x 120 x 3,2h SX/DX**	1	-	10,80	EPAL	80 x 120
20 mm					
GRADONE 50 x 100**	1	-	15	PALLET	103 x 103
GRADONE 50 x 100 SX/DX**	1	-	15	PALLET	103 x 103
GRIGLIA 20 x 100**	1	-	8	PALLET	103 x 103
GRIGLIA 20 x 100 SX/DX**	1	-	8	PALLET	103 x 103

** A disposizione solo su richiesta. Tempi di consegna: 30gg
Available upon request only. Delivery terms: 30 days
Disponible seulement sur requête. Délais de livraison: 30 jours
Verfügbar auf Anfrage. Lieferzeit: 30 Tage

Le Malte

glow
boutique

Le Malte
MATERICO

GREY

TAUPE

BEIGE

IVORY

SAGE

AVIO

V1
SHADE SPECTRUM
LOW

ISO 13006 - G - Bla_E ≤ 0,5% - UNI EN 14411 - UGL
ANSI A - 326.3: 2021
WET DYNAMIC COEFFICIENT OF FRICTION | DCOF ≥ 0,42

100 % DESIGN AND
PRODUCTION OF ITALY

Le Malte
MATERICO

6 mm



120x280
48"x110"
Nat Ret



120x120
48"x48"
Nat Ret



60x120
24"x48"
Nat Ret

8,8 mm



80x80
31 1/2"x31 1/2"
Nat Ret

Ivory
Beige
Grey
Taupe

Le Malte

120x280 6mm



GREY



TAUPE

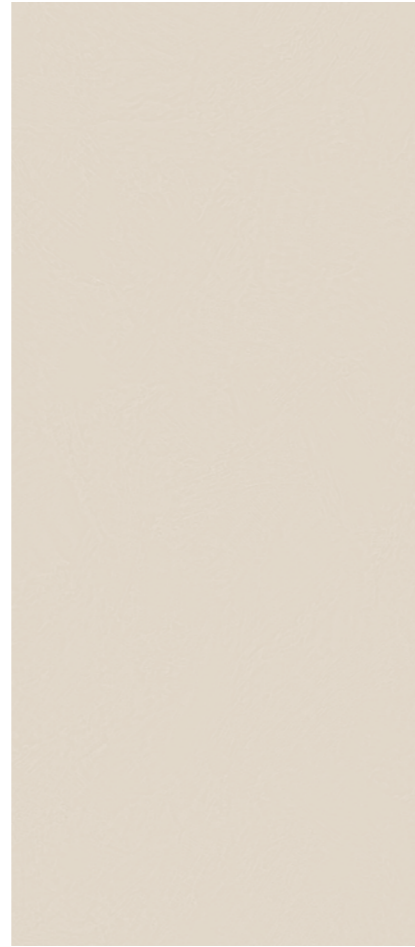

BEIGE

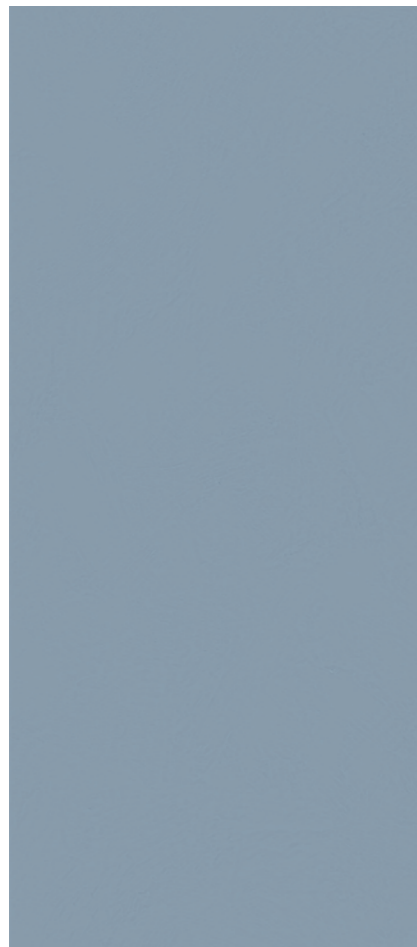

AVIO



SAGE

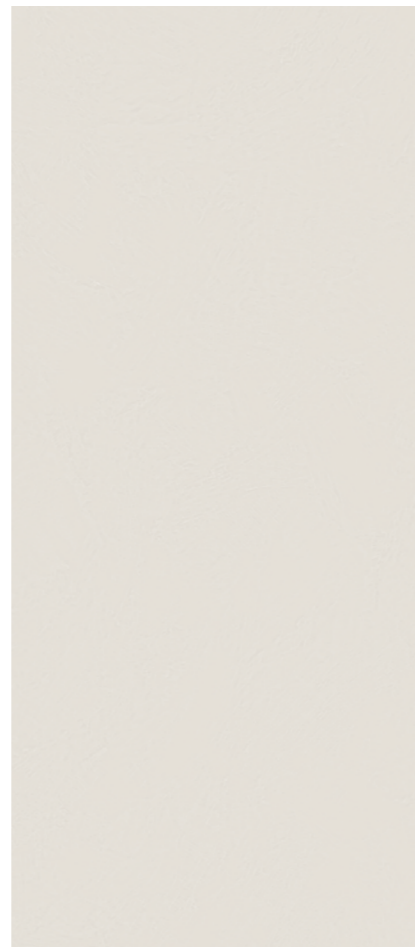

IVORY



Floor
Beige 60x120_24"x48" Nat Ret

Wall
Sage 60x120_24"x48" Nat Ret

Le Malte

6 mm



120x280
48"x110"



120x120
48"x48"



60x120
24"x48"

	Nat Ret	Nat Ret	Nat Ret
GREY	198003	198013	198023
TAUPE	198005	198015	198025
BEIGE	198004	198014	198024
IVORY	198002	198012	198022
SAGE	198006	198016	198026
AVIO	198001	198011	198021
Price code	M153	M141	M118

8,8 mm



80x80
31 1/2"x31 1/2"

	Nat Ret
GREY	198033
TAUPE	198035
BEIGE	198034
IVORY	198032
Price code	M097

Pezzi Speciali / Trims. Pièces speciale. Die Sonderstücke

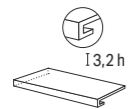

13,2 h

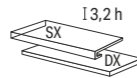

13,2 h

6 mm

Gradino costa retta**
Straight nosed stair**

Gradino costa retta SX - DX**
Straight-edge step L-R

	33x120 Nat Ret	33x120 Nat Ret
GREY	198063	198083 SX 198093 DX
TAUPE	198065	198085 SX 198095 DX
BEIGE	198064	198084 SX 198094 DX
IVORY	198062	198082 SX 198092 DX
SAGE	198066	198086 SX 198096 DX
AVIO	198061	198081 SX 198091 DX
Price code	P243	P273



Battiscopa
Skirting

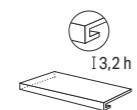

13,2 h

Gradino costa retta**
Straight nosed stair**

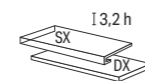

13,2 h

Gradino costa retta SX - DX**
Straight-edge step L-R

8,8 mm

	8x80 Nat Ret	33x80 Nat Ret	33x80 Nat Ret
GREY	198053	198073	198103 SX 198113 DX
TAUPE	198055	198075	198105 SX 198115 DX
BEIGE	198054	198074	198104 SX 198114 DX
IVORY	198052	198072	198102 SX 198112 DX
Price code	P029	P167	P179



Wall
Taupe 120x280_48"x110" Nat Ret
Bolgheri Stone Sage 120x280_48"x110" Lap Ret

Floor
Taupe 120x280_48"x110" Nat Ret

Imballi / Packings. Emballage. Verpackung

	PCS/BOX	MQ/BOX	KG/BOX	PCS/PAL	BOX/PAL	MQ/PAL	KG/PAL	PACKING	PACKING SIZE	TARE (KG)
6 mm										
120 x 280	-	-	-	20	-	67,20	1.081	CASSA	292 x 145 x 35h	108
120 x 120	-	-	-	44	-	147,84	2.285	CAVALLETTO LEGNO	290 x 75 x 161h	145
60 x 120	2	2,88	41,76	48	24	69,12	1002	PALLET SPECIALE	123x 143 x 74h	29
80 x 120	2	1,44	21	-	40	57,60	842	EPAL	80 x 120 x 75h	22
8,8 mm										
80 x 80	2	1,28	23,2	-	50	64	1.161	EPAL	80 x 120 x 95h	22



Cavalletto in legno
Wood A-Frame. Support en bois.
Holzgestell



Cassa
Crate . Caisse . Kiste



Pallet speciale con sponde
Special pallet with sides .
Palette spéciale avec bords.
Spezial-Palette mit Wandungen.



Epal

PEZZI SPECIALI. TRIMS	PCS/BOX	MQ/BOX	KG/BOX	PACKING	PACKING SIZE	TARE (KG)
6 mm						
GRADINO COSTA RETTA 33 x 120 x 3,2h **	2	-	14	EPAL	80 x 120	22
GRADINO COSTA RETTA 33 x 120 x 3,2h SX/DX **	1	-	7	EPAL	80 x 120	22
8,8 mm						
BATTISCOPA 8 x 80	10	-	15,00	EPAL	80 x 120	22
GRADINO COSTA RETTA 33 x 80 x 3,2h **	2	-	16	EPAL	80 x 120	22
GRADINO COSTA RETTA 33 x 80 x 3,2h SX/DX **	1	-	8,50	EPAL	80 x 120	22

** A disposizione solo su richiesta. Tempi di consegna: 30gg
Available upon request only. Delivery terms: 30 days
Disponible seulement sur requête. Délais de livraison: 30 jours
Verfügbar auf Anfrage. Lieferzeit: 30 Tage

Space

Space
MATERICO

PLOMB

CEMENT

BONE

V2
SHADE SPECTRUM
MODERATE

ISO 13006 - G - Bla_E ≤ 0,5% - UNI EN 14411 - UGL
ANSI A - 326.3: 2021
WET DYNAMIC COEFFICIENT OF FRICTION | DCOF ≥ 0,42

100 % DESIGN AND
PRODUCTION OF ITALY

Space
MATERICO

8,8 mm R10B

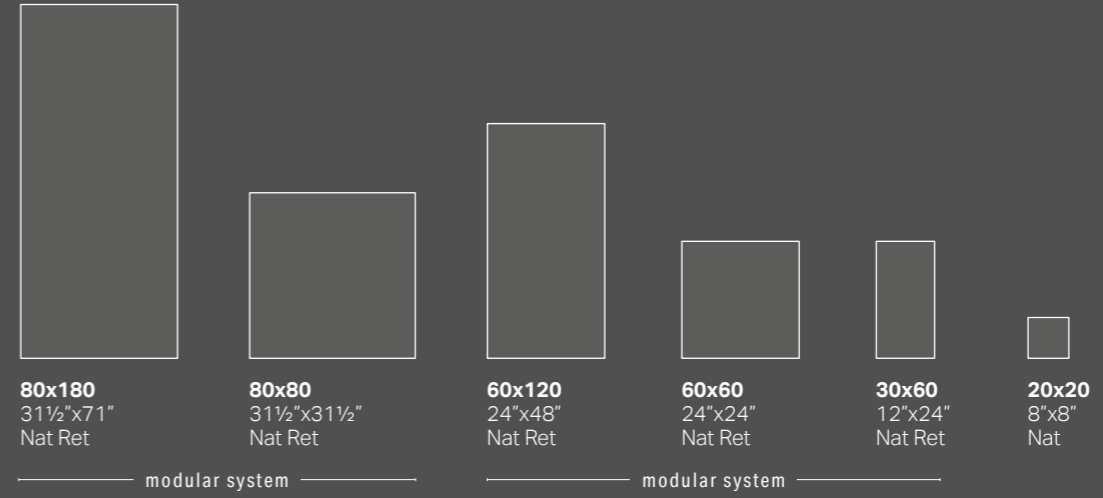

Decori / Decors

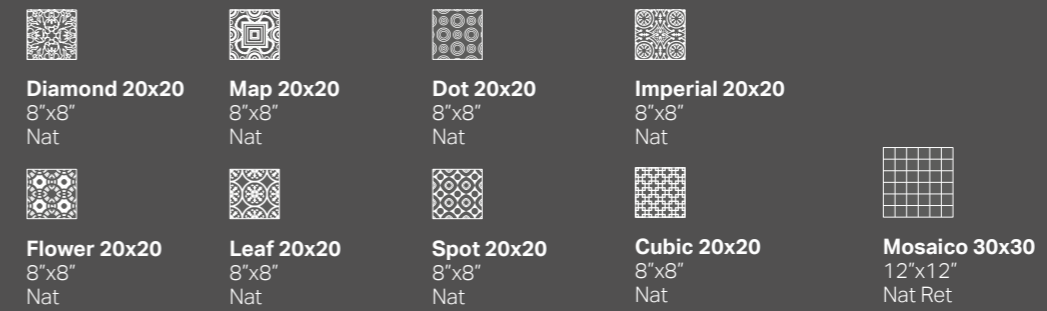

8,8 mm OUTDOOR R11C

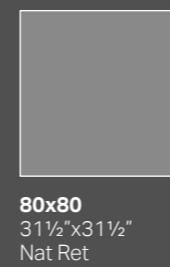

20 mm OUTDOOR R11C



Sviluppo grafico per formato
Pattern by size
Développement graphique par format
Grafischer Entwurf für Format



80x180 8,8 mm	60x120 8,8 mm	80x80 8,8 mm	60x60 8,8 mm	30x60 8,8 mm	20x20 8,8 mm	80x80 20 mm
12	24	25	46	92	10	25

Sviluppo Grafico

Pattern by size. Développement graphique par format. Grafischer Entwurf für Format

CEMENT 60x120 8,8 mm

24 patterns



Decori

Decors

8,8 mm R10B

PLOMB

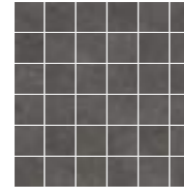

Mosaico 30x30
12"x12"
Nat Ret



**** Pattern 20x20_8"x8"**
Nat



*** Diamond**
20x20_8"x8"
Nat



*** Map**
20x20_8"x8"
Nat



*** Dot**
20x20_8"x8"
Nat



*** Imperial**
20x20_8"x8"
Nat

CEMENT



Mosaico 30x30
12"x12"
Nat Ret

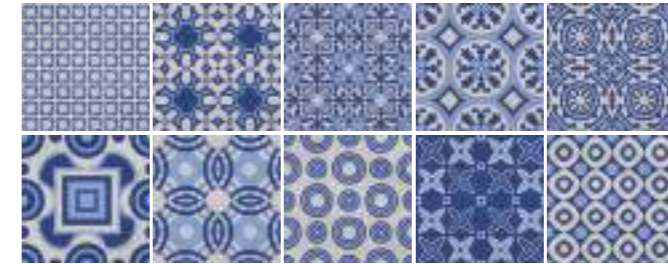

**** Pattern 20x20_8"x8"**
Nat



*** Flower**
20x20_8"x8"
Nat



*** Leaf**
20x20_8"x8"
Nat



*** Spot**
20x20_8"x8"
Nat



*** Imperial**
20x20_8"x8"
Nat

BONE



Mosaico 30x30
12"x12"
Nat Ret



**** Pattern 20x20_8"x8"**
Nat



*** Flower**
20x20_8"x8"
Nat



*** Leaf**
20x20_8"x8"
Nat

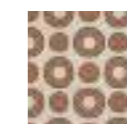

*** Dot**
20x20_8"x8"
Nat

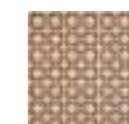

*** Cubic**
20x20_8"x8"
Nat

*** Questo formato non è modulare ed abbinabile agli altri formati in gamma**

This size is not modular and cannot be used together with the other sizes in the range.

Ce format n'est pas modulaire et il ne peut être associé aux autres formats de la gamme.

Dieses Format ist nicht modular und lässt sich mit anderen Formaten der Serie kombinieren.

**** In ogni scatola la combinazione dei soggetti è del tutto casuale. Lo stesso soggetto potrebbe essere ripetuto oppure potrebbe non essere presente nella scatola.**

Each box contains a random assortment of the designs available. The same design may be repeated and certain designs may not be included in the box.

La combinaison des motifs à l'intérieur de chaque boîte est absolument fortuite. Le même motif pourrait être répété ou ne pas se trouver à l'intérieur de la boîte.

Die Zusammenstellung der Motive ist in jedem Karton vollkommen zufällig. Das selbe Motiv könnte sich wiederholen oder nicht im Karton vorhanden sei

Space

8,8 mm R10B

	80x180 31 1/2"x71"	80x80 31 1/2"x31 1/2"	60x120 24"x48"	60x60 24"x24"	30x60 12"x24"	20x20* 8"x8"
	Nat Ret	Nat Ret	Nat Ret	Nat Ret	Nat Ret	Nat
PLOMB	106003	106008	106023	106028	106033	106073
CEMENT	106002	106007	106022	106027	106032	106072
BONE	106001	106006	106021	106026	106031	106071
Price code	M125	M097	M097	M083	M081	M075

8,8 mm R11C

	80x80 31 1/2"x31 1/2"	80x80 31 1/2"x31 1/2"
	Nat Ret	Nat Ret
PLOMB	106013	106018
CEMENT	106012	106017
BONE	106011	106016
Price code	M097	M137

8,8 mm R10B

	Mosaico 30x30 12"x12"	Flower* 20x20 8"x8"	Leaf* 20x20 8"x8"	Dot* 20x20 8"x8"	Cubic* 20x20 8"x8"	Imperial* 20x20 8"x8"	Spot* 20x20 8"x8"	Diamond* 20x20 8"x8"	Map* 20x20 8"x8"	Pattern*** 20x20 8"x8"
	Nat Ret	Nat	Nat	Nat	Nat	Nat	Nat	Nat	Nat	Nat
PLOMB	106053	-	-	106087	-	106085	-	106086	106088	106076
CEMENT	106052	106083	106081	-	-	106082	106084	-	-	106075
BONE	106051	106077	106078	106079	106080	-	-	-	-	106074
Price code	M135	M081	M081	M081	M081	M081	M081	M081	M081	M081

Pezzi Speciali / Trims. Pièces speciale. Die Sonderstücke

8,8 mm R10B

	Battiscopa Skirting	Gradino costa retta*** Straight nosed stair**	Gradino costa retta SX - DX*** Straight-edge step L-R					
	6,5x120	7x60	33x120	33x80	33x60	33x120	33x80	33x60
	Nat Ret	Nat Ret	Nat Ret	Nat Ret	Nat Ret	Nat Ret	Nat Ret	Nat Ret
PLOMB	106063	106068	106107	106127	106206	106109 SX 106108 DX	106129 SX 106128 DX	106208 SX 106207 DX
CEMENT	106062	106067	106104	106124	106203	106106 SX 106105 DX	106126 SX 106125 DX	106205 SX 106204 DX
BONE	106061	106066	106101	106121	106200	106103 SX 106102 DX	106123 SX 106122 DX	106202 SX 106201 DX
Price code	P040	P021	P207	P167	P135	P219	P179	P151

20 mm R11C

	Gradone*** Large step	Gradone Angolo Sx/Dx *** Large step - Corner L/R		
	40x80	40x80		
	Costa toro Nat Ret	Costa retta Nat Ret	Costa toro Nat Ret	Costa retta Nat Ret
PLOMB	106389	106380	106395 SX 106392 DX	106386 SX 106383 DX
CEMENT	106388	106379	106394 SX 106391 DX	106385 SX 106382 DX
BONE	106387	106378	106393 SX 106390 DX	106384 SX 106381 DX
Price code	P181	P175	P203	P197

	Griglia *** Drainage grid	Griglia - Angolo Sx/Dx *** Drainage grid - Corner L/R
	20x80	20x80
PLOMB	106398	106404 SX 106401 DX
CEMENT	106397	106403 SX 106400 DX
BONE	106396	106402 SX 106399 DX
Price code	P239	P239

La gamma completa dei pezzi speciali è disponibile nella "PARTE TECNICA" del catalogo a pag. 493

Our entire range of trims is available in our "TECHNICAL SECTION" of this catalogue pag. 493.

La gamme complète des pièces spéciales est disponible dans la section "PARTIE TECHNIQUE" à la pag. 493 de ce catalogue.

Das komplette Sortiment an Sonderstücken ist in dem "technischen Teil" des Katalogs auf Seite 493 verfügbar.

Imballi / Packings. Emballage. Verpackung

	PCS/BOX	MQ/BOX	KG/BOX	BOX/PAL	MQ/PAL	KG/PAL	PACKING	PACKING SIZE
8,8 mm								
80 x 180	2	2,88	69,12	20	57,60	1.418	PALLET CON SPONDE	184 x 97 x 45h
80 x 80	2	1,28	23,6	50	64	1.200	EPAL	80 x 120 x 95h
80 x 80 R11 C	2	1,28	23,6	50	64	1.200	EPAL	80 x 120 x 95h
60 x 120	2	1,44	32,68	32	46,08	1.066	EPAL	80 x 120 x 75h
60 x 60	3	1,08	25,38	40	43,20	1.035	EPAL	80 x 120 x 75h
30 x 60	6	1,08	25,38	40	43,20	1.035	EPAL	80 x 120 x 75h
20 x 20 *	30	1,20	23,04	60	72,00	1.397	PALLET	80 x 120 x 75h
DECORI. DECORS								
20 x 20 *	30	1,20	23,04	60	72,00	1.397	PALLET	80 x 120 x 75h
PATTERN 20 x 20 * **	30	1,20	23,04	60	72,00	1.397	PALLET	80 x 120 x 75h
MOSAICO 30 x 30	6	0,54	13,00	54	29,16	722	EPAL	80 x 120 x 75h
20 mm								
80 x 80	1	0,64	27,78	40	25,60	1.130	EPAL	80 x 120 x 95h

Pallet speciale con sponde
Special pallet with sides.
Palette spéciale avec bords.
Spezial-Palette mit Wandungen.

Epal / Pallet

** In ogni scatola la combinazione dei soggetti è del tutto casuale. Lo stesso soggetto potrebbe essere ripetuto oppure potrebbe non essere presente nella scatola.

Each box contains a random assortment of the designs available. The same design may be repeated and certain designs may not be included in the box.

La combinaison des motifs à l'intérieur de chaque boîte est absolument fortuite. Le même motif pourrait être répété ou ne pas se trouver à l'intérieur de la boîte. Die Zusammenstellung der Motive ist in jedem Karton vollkommen zufällig. Das selbe Motiv könnte sich wiederholen oder nicht im Karton vorhanden sei

PEZZI SPECIALI. TRIMS	PCS/BOX	MQ/BOX	KG/BOX	BOX/PAL	MQ/PAL	KG/PAL	PACKING	PACKING SIZE
8,8 mm								
BATTISCOPA 6,5 x 120	6	0,47	10,55	45	21,15	495	EPAL	80 x 120 x 55h
BATTISCOPA 7 x 60	15	0,63	14,76	56	35,28	846	EPAL	80 x 120 x 50h
GRADINO COSTA RETTA 33 x 120 ***	2	-	23,00	-	-	-	EPAL	80 x 120
GRADINO COSTA RETTA 33 x 120 SX/DX ***	1	-	12,00	-	-	-	EPAL	80 x 120
GRADINO COSTA RETTA 33 x 80 ***	2	-	16,00	-	-	-	EPAL	80 x 120
GRADINO COSTA RETTA 33 x 80 SX/DX ***	1	-	8,50	-	-	-	EPAL	80 x 120
GRADINO COSTA RETTA 33 x 60 ***	4	-	23,00	-	-	-	EPAL	80 x 120
GRADINO COSTA RETTA 33 x 60 SX/DX ***	2	-	12,00	-	-	-	EPAL	80 x 120

PEZZI SPECIALI. TRIMS	PCS/BOX	MQ/BOX	KG/BOX	PACKING	PACKING SIZE
20 mm					
GRADONE 40 x 80 ***	1	-	12,50	EPAL	80 x 120
GRADONE 40 x 80 SX/DX ***	1	-	12,50	EPAL	80 x 120
GRIGLIA 20 x 80 ***	1	-	8,00	EPAL	80 x 120
GRIGLIA 20 x 80 SX/DX ***	1	-	7,50	EPAL	80 x 120

* Questo formato non è modulare ed abbinabile agli altri formati in gamma
This size is not modular and cannot be used together with the other sizes in the range.
Ce format n'est pas modulaire et il ne peut être associé aux autres formats de la gamme.
Dieses Format ist nicht modular und lässt sich mit anderen Formaten der Serie kombinieren.

*** A disposizione solo su richiesta. Tempi di consegna: 30gg
Available upon request only. Delivery terms: 30 days
Disponible seulement sur requête. Délais de livraison: 30 jours
Verfügbar auf Anfrage. Lieferzeit: 30 Tage

La gamma completa dei pezzi speciali è disponibile nella "PARTE TECNICA" del catalogo a pag. 493

Our entire range of trims is available in our "TECHNICAL SECTION" of this catalogue pag. 493.

La gamme complète des pièces spéciales est disponible dans la section "PARTIE TECHNIQUE" à la pag. 493 de ce catalogue.

Das komplette Sortiment an Sonderstücken ist in dem "technischen Teil" des Katalogs auf Seite 493 verfügbar.



Agglomerate
MATERICO

*Agglo
me
rate*

TAHITI

AGATE

PEARL

SHELL

V2
SHADE SPECTRUM
MODERATE

ISO 13006 - G - Bla_E ≤ 0,5% - UNI EN 14411 - UGL
ANSI A - 326.3: 2021
WET DYNAMIC COEFFICIENT OF FRICTION | DCOF ≥ 0,42

100 % DESIGN AND
PRODUCTION OF ITALY

Agglomerate
MATERICO

8,8 mm R10B

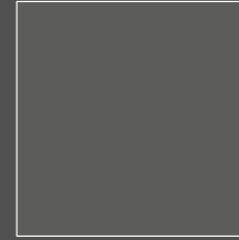

120x120
48"x48"
Nat Ret



60x120
24"x48"
Nat Ret



60x60
24"x24"
Nat Ret



30x60
12"x24"
Nat Ret



80x80
31 1/2"x31 1/2"
Nat Ret

modular system

Decor / Decors



Quadrotto 30x30
12"x12"
Nat Lap



Freccia 30x35
12"x13 3/4"
Nat Lap

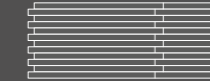

Muretto 30x63
12"x25"
Nat Lap



Fascia 30x120
12"x48"
Lap

4
PATTERNS

Bacchetta di metallo 0,8x120
1/8"x48"

20 mm OUTDOOR R11C



80x80
31 1/2"x31 1/2"
Nat Ret

Sviluppo grafico per formato
Pattern by size
Développement graphique par format
Grafischer Entwurf für Format



120x120
8,8 mm

8

60x120
8,8 mm

12

80x80
8,8 mm

15

60x60
8,8 mm

24

30x60
8,8 mm

47

80x80
20 mm

15

Sviluppo Grafico

Pattern by size. Développement graphique par format. Grafischer Entwurf für Format.

SHELL 60x120 8,8 mm

12 patterns



Decori

Decors

8,8 mm R10B

TAHITI



Quadrotto 30x30
12"x12"
Nat Lap



Freccia 30x35
12"x13 3/4"
Nat Lap



Muretto 30x63
12"x25"
Nat Lap

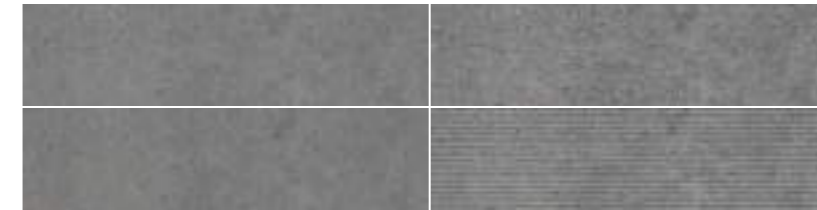

Fascia 30x120
12"x48"
Lap

AGATE



Quadrotto 30x30
12"x12"
Nat Lap



Freccia 30x35
12"x13 3/4"
Nat Lap



Muretto 30x63
12"x25"
Nat Lap



Fascia 30x120
12"x48"
Lap

PEARL



Quadrotto 30x30
12"x12"
Nat Lap



Freccia 30x35
12"x13 3/4"
Nat Lap



Muretto 30x63
12"x25"
Nat Lap



Fascia 30x120
12"x48"
Lap

SHELL



Quadrotto 30x30
12"x12"
Nat Lap



Freccia 30x35
12"x13 3/4"
Nat Lap



Muretto 30x63
12"x25"
Nat Lap



Fascia 30x120
12"x48"
Lap



**Bacchetta di metallo
Ferro Battuto 0,8x120**
1/3"x48"



**Bacchetta di metallo
Corten 0,8x120**
1/3"x48"



**Bacchetta di metallo
Ferro Goccia 0,8x120**
1/3"x48"

Agglomerate

8,8 mm
R10B

	120x120 48"x48"	60x120 24"x48"	60x60 24"x24"	30x60 12"x24"	80x80 31 1/2"x31 1/2"
	Nat Ret	Nat Ret	Nat Ret	Nat Ret	Nat Ret
TAHITI	160044	160004	160014	160024	160034
AGATE	160043	160003	160013	160023	160033
PEARL	160041	160001	160011	160021	160031
SHELL	160042	160002	160012	160022	160032
Price code	M121	M097	M083	M081	M097

20 mm
R11C

	80x80 31 1/2"x31 1/2"
	Nat Ret
TAHITI	160054
AGATE	160053
PEARL	160051
SHELL	160052
Price code	M137

8,8 mm
R10B

	Fascia 30x120 * 12"x48" Lap	Muretto 30x63 12"x25" Nat Lap	Quadrotto 30x30 12"x12" Nat Lap	Freccia 30x35 12"x13 3/4" Nat Lap
TAHITI	160064	160324	160314	160304
AGATE	160063	160323	160313	160303
PEARL	160061	160321	160311	160301
SHELL	160062	160322	160312	160302
Price code	M125	M251	M265	M217

	Ferro Goccia 0,8x120 1/8"x48"	Metallo Corten 0,8x120 1/8"x48"	Ferro Battuto 0,8x120 1/8"x48"
160601	160602	160603	
P069	P069	P069	

Pezzi Speciali / Trims. Pièces speciale. Die Sonderstücke

	Battiscopa Skirting	Gradino costa retta** Straight nosed stair**	Gradino costa retta SX - DX** Straight-edge step L-R
	8x80	7x60	33x120
	Nat Ret	Nat Ret	Nat Ret
TAHITI	160104	160114	160204
AGATE	160103	160113	160203
PEARL	160101	160111	160201
SHELL	160102	160112	160202
Price code	P029	P021	P207

20 mm
R11C

	Gradone ** Large step
	40x80
	Costa toro Nat Ret
TAHITI	160404
AGATE	160403
PEARL	160401
SHELL	160402
Price code	P181

La gamma completa dei pezzi speciali è disponibile nella "PARTE TECNICA" del catalogo a pag. 493

Our entire range of trims is available in our "TECHNICAL SECTION" of this catalogue pag. 493.

La gamme complète des pièces spéciales est disponible dans la section "PARTIE TECHNIQUE" à la pag. 493 de ce catalogue.

Das komplette Sortiment an Sonderstücken ist in dem "technischen Teil" des Katalogs auf Seite 493 verfügbar.



Wall
Pearl 30x60_12"x24" Nat Ret
Decoro Muretto Agate 30x63_12"x25" Nat Lap

Floor
Agate 120x120_48"x48" Nat Ret
Agate 60x120_24"x48" Nat Lap

Imballi / Packings. Emballage. Verpackung

	PCS/BOX	MQ/BOX	KG/BOX	BOX/PAL	MQ/PAL	KG/PAL	PACKING	PACKING SIZE
8,8 mm								
120 x 120	2	2,88	57,06	16	46,08	942	PALLET CON SPONDE	123x 143 x 74h
60 x 120	2	1,44	30,13	30	43,20	926	EPAL	80 x 120 x 75h
60 x 60	3	1,08	22,84	40	43,20	934	EPAL	80 x 120 x 75h
30 x 60	7	1,26	25,08	40	50,40	1.023	EPAL	80 x 120 x 75h
80 x 80	2	1,28	24,4	50	64,00	1.240	EPAL	80 x 120 x 95h
DECORI. DECORS								
FASCIA 30 x 120 *	4	1,44	29,52	21	30,24	642	EPAL	107 x 123 x 43h
MURETTO 30 x 63	5	0,9	18	30	27	560	EPAL	80 x 120 x 60h
FRECCIA 30 x 35	6	0,63	12,90	-	-	-	EPAL	80 x 120
QUADROTTI 30 x 30	6	0,54	10,75	-	-	-	EPAL	80 x 120
BACCICHETTE DI METALLO 0,8 x 120	6	-	4	-	-	-	EPAL	80 x 120
20 mm								
80 x 80	1	0,64	28,14	40	25,60	1.145	EPAL	80 x 120 x 95h

EPAL / Pallet



Pallet speciale con sponde
Special pallet with sides.
Palette spéciale avec bords.
Spezial-Palette mit Wandungen.

PEZZI SPECIALI. TRIMS	PCS/BOX	MQ/BOX	KG/BOX	PACKING	PACKING SIZE
8,8 mm					
BATTISCOPA 8 x 80	11	0,70	14,80	EPAL	80 x 120
BATTISCOPA 7 x 60	15	0,63	13,28	EPAL	80 x 120
GRADINO COSTA RETTA 33 x 120 x 3,2h**	2	-	20,70	EPAL	80 x 120
GRADINO COSTA RETTA 33 x 120 x 3,2h/SX/DX **	1	-	10,80	EPAL	80 x 120
20 mm					
GRADONE 40x80 **	1	-	12,5	EPAL	80 x 120

** A disposizione solo su richiesta.

Tempi di consegna: 30gg

Available upon request only.

Delivery terms: 30 days

Disponible seulement sur requête.

Délais de livraison: 30 jours

Verfügbar auf Anfrage.

Lieferzeit: 30 Tage

La gamma completa dei pezzi speciali è disponibile nella "PARTE TECNICA" del catalogo a pag. 493

Our entire range of trims is available in our "TECHNICAL SECTION" of this catalogue pag. 493.

La gamme complète des pièces spéciales est disponible dans la section "PARTIE TECHNIQUE" à la pag. 493 de ce catalogue.

Das komplette Sortiment an Sonderstücken ist in dem "technischen Teil" des Katalogs auf Seite 493 verfügbar.

Artile
MATERICO

Ar.
tile

BLACK GOLD

SAGE

OCEAN BLUE

IVORY

GREIGE

COPPER

V3
SHADE SPECTRUM
HIGH

ISO 13006 - G - Bla_E ≤ 0,5% - UNI EN 14411 - UGL
ANSI A - 326.3: 2021
WET DYNAMIC COEFFICIENT OF FRICTION | DCOF ≥ 0,42

100 % DESIGN AND
PRODUCTION OF ITALY

Artile
MATERICO

8,8 mm R10A



60x120
24"x48"
Nat Ret



20x120
8"x48"
Nat Ret



60x60
24"x24"
Nat Ret



30x60
12"x24"
Nat Ret

modular system

Decor / Decors



Mosaico 30x30
12"x12"
Nat Ret



Muretto 30x30
12"x12"
Nat Ret



Esagona 28x29
11"x11 1/2"
Nat Ret



Spina di pesce 27x25,5
10 1/2"x10"
Nat Ret

Sviluppo grafico per formato
Pattern by size
Développement graphique par format
Grafischer Entwurf für Format



60x120
8,8 mm
18

20x120
8,8 mm
12

60x60
8,8 mm
36

30x60
8,8 mm
18

Sviluppo Grafico

Pattern by size. Développement graphique par format. Grafischer Entwurf für Format

IVORY 60x120 8,8 mm

18 patterns



Decorì

Decors

8,8 mm R10A

BLACK GOLD



SAGE

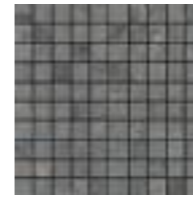

OCEAN BLUE

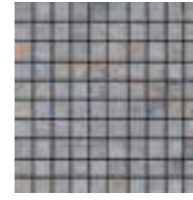

IVORY



GREIGE

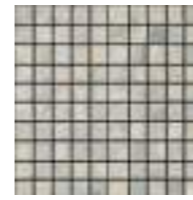

COPPER

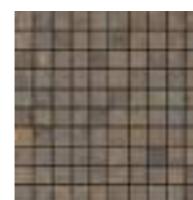

Mosaico 30x30
12"x12"
Nat Ret

Muretto 30x30
12"x12"
Nat Ret

Esagona 28x29
11"x11 1/2"
Nat Ret

Spina di pesce 27x25,5
10 1/2"x10"
Nat Ret

Artile

8,8 mm
R 10A



60x120
24"x48"

20x120
8"x48"

60x60
24"x24"

30x60
12"x24"

Nat Ret

Nat Ret

Nat Ret

Nat Ret

	60x120 24"x48"	20x120 8"x48"	60x60 24"x24"	30x60 12"x24"
BLACK GOLD	156006	156031	156011	156021
SAGE	156005	156035	156015	156025
OCEAN BLUE	156004	156036	156016	156026
IVORY	156001	156033	156013	156023
GREIGE	156002	156032	156012	156022
COPPER	156003	156034	156014	156024
Price code	M109	M109	M093	M085

8,8 mm
R 10A



Mosaico
30x30
12"x12"

Muretto
30x30
12"x12"

Esagona
28x29
11"x11 1/2"

Spina di pesce
27x25,5
10 1/2"x10"

Nat Ret

Nat Ret

Nat Ret

Nat Ret

	Mosaico 30x30 12"x12"	Muretto 30x30 12"x12"	Esagona 28x29 11"x11 1/2"	Spina di pesce 27x25,5 10 1/2"x10"
BLACK GOLD	156321	156311	156331	156301
SAGE	156325	156315	156335	156305
OCEAN BLUE	156326	156316	156336	156306
IVORY	156323	156313	156333	156303
GREIGE	156322	156312	156332	156302
COPPER	156324	156314	156334	156304
Price code	M193	M199	M303	M177

Pezzi Speciali / Trims. Pièces speciale. Die Sonderstücke

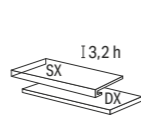
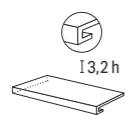
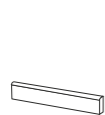

8,8 mm
R 10A

Battiscopa
Skirting

Gradino costa retta**
Straight nosed stair**

Gradino costa retta SX - DX**
Straight-edge step L-R

7x60

33x120

33x120

Nat Ret

Nat Ret

Nat Ret

	7x60	33x120	33x120
BLACK GOLD	156101	156201	156221 SX 156211 DX
SAGE	156105	156205	156225 SX 156215 DX
OCEAN BLUE	156106	156206	156226 SX 156216 DX
IVORY	156103	156203	156223 SX 156213 DX
GREIGE	156102	156202	156222 SX 156212 DX
COPPER	156104	156204	156224 SX 156214 DX
Price code	P021	P207	P231



Wall
Ivory 60x120_24"x48" Nat Ret

Floor
Greige 60x120_24"x48" Nat Ret

Imballi / Packings. Emballage. Verpackung

	PCS/BOX	MQ/BOX	KG/BOX	BOX/PAL	MQ/PAL	KG/PAL	PACKING	PACKING SIZE
8,8 mm								
60 x 120	2	1,44	33,12	32	46,08	1.080	EPAL	80 x 120 x 75h
20 x 120	4	0,96	18,40	60	57,60	1.239	EPAL	80 x 120 x 70h
60 x 60	3	1,08	25,38	40	43,20	1.035	EPAL	80 x 120 x 75h
30 x 60	7	1,26	24,00	48	60,48	1.172	EPAL	80 x 120 x 75h
DECORI. DECORS								
MOSAICO 30 x 30	6	0,54	10,36	60	32,40	642	EPAL	80 x 120
MURETTO 30 x 30	6	0,54	10,36	60	32,40	642	EPAL	80 x 120
ESAGONA 28 x 29	6	0,48	9,41	60	28,80	585	EPAL	80 x 120
SPINA DI PESCE 27 x 25,5	6	0,42	8,70	60	25,20	504	EPAL	80 x 120

PEZZI SPECIALI. TRIMS	PCS/BOX	MQ/BOX	KG/BOX	PACKING	PACKING SIZE
8,8 mm					
BATTISCOPA 7 x 60	15	0,63	13	EPAL	80 x 120
GRADINO COSTA RETTA 33 x 120 x 3,2h **	2	-	23	EPAL	80 x 120
GRADINO COSTA RETTA 33 x 120 x 3,2h SX/DX **	1	-	12	EPAL	80 x 120

** A disposizione solo su richiesta. Tempi di consegna: 30gg
Available upon request only. Delivery terms: 30 days
Disponible seulement sur requête. Délais de livraison: 30 jours
Verfügbar auf Anfrage. Lieferzeit: 30 Tage

Lascaux

MATERICO



Lascaux

KIMBERLY

NAXA

JEITA

CAPRI

ELLISON

V3
SHADE SPECTRUM
HIGH

ISO 13006 - G - Bla_E ≤ 0,5% - UNI EN 14411 - GL
ANSI A - 326.3: 2021
WET DYNAMIC COEFFICIENT OF FRICTION

DCOF ≥ 0,42
naturale
100 % DESIGN AND
PRODUCTION OF ITALY

Lascaux
MATERICO

8,8 mm R10A naturale



60x120
24"x48"
Nat Ret
Lap Ret



30x120
12"x48"
Nat Ret
Lap Ret



20x120
8"x48"
Nat Ret
Lap Ret



60x60
24"x24"
Nat Ret
Lap Ret



30x60
12"x24"
Nat Ret
Lap Ret

modular system

Decoro / Decor



Mosaico 30x30
12"x12"
Nat Ret
Lap Ret

Sviluppo grafico per formato
Pattern by size
Développement graphique par format
Grafischer Entwurf für Format



60x120
8,8 mm

23

30x120
8,8 mm

38

20x120
8,8 mm

68

60x60
8,8 mm

29

30x60
8,8 mm

33

Sviluppo Grafico

Pattern by size. Développement graphique par format. Grafischer Entwurf für Format

Lascaux
MATERICO

KIMBERLY 60x120 8,8 mm

23 patterns



8,8 mm
R 10 A
naturale

	60x120 24"x48"		30x120 12"x48"		20x120 8"x48"		60x60 24"x24"		30x60 12"x24"		Mosaico 30x30 12"x12"	
	Nat Ret	Lap Ret	Nat Ret	Lap Ret	Nat Ret	Lap Ret	Nat Ret	Lap Ret	Nat Ret	Lap Ret	Nat Ret	Lap Ret
KIMBERLY	089013	089014	089033	089034	089053	089054	089093	089094	089113	089114	089173	089174
NAXA	089017	089018	089037	089038	089057	089058	089097	089098	089117	089118	089177	089178
JEITA	089009	089010	089029	089030	089049	089050	089089	089090	089109	089110	089169	089170
CAPRI	089001	089002	089021	089022	089041	089042	089081	089082	089101	089102	089161	089162
ELLISON	089005	089006	089025	089026	089045	089046	089085	089086	089105	089106	089165	089166
Price code	M109	M125	M113	M129	M113	M129	M089	M113	M089	M113	M159	M187

Pezzi Speciali / Trims. Pièces speciale. Die Sonderstücke

8,8 mm
R 10 A
naturale

	6,5x120		33x120		33x60		33x120		33x60	
	Nat Ret	Lap Ret	Nat Ret	Lap Ret	Nat Ret	Lap Ret	Nat Ret	Lap Ret	Nat Ret	Lap Ret
KIMBERLY	089188	089189	089272	089273	089212	089213	089312 SX 089292 DX	089313 SX 089293 DX	089252 SX 089232 DX	089253 SX 089233 DX
NAXA	089190	089191	089276	089277	089216	089217	089316 SX 089296 DX	089317 SX 089297 DX	089256 SX 089236 DX	089257 SX 089237 DX
JEITA	089186	089187	089268	089269	089208	089209	089308 SX 089288 DX	089309 SX 089289 DX	089248 SX 089228 DX	089249 SX 089229 DX
CAPRI	089181	089182	089260	089261	089200	089201	089300 SX 089280 DX	089301 SX 089281 DX	089240 SX 089220 DX	089241 SX 089221 DX
ELLISON	089183	089184	089264	089265	089204	089205	089304 SX 089284 DX	089305 SX 089285 DX	089244 SX 089224 DX	089245 SX 089225 DX
Price code	P040	P043	P207	P215	P141	P143	P231	P243	P169	P173

Imballi / Packings. Emballage. Verpackung

	PCS/BOX	MQ/BOX	KG/BOX	BOX/PAL	MQ/PAL	KG/PAL	PACKING	PACKING SIZE
8,8 mm								
60 x 120 Nat	2	1,44	27,90	32	46,08	892,80	EPAL	80 x 120 x 75h
60 x 120 Lap	2	1,44	27,90	30	43,20	837	EPAL	80 x 120 x 75h
30 x 120	3	1,08	21	45	48,60	945	EPAL	80 x 120 x 75h
20 x 120 Lap	6	1,44	27,90	24	34,56	669,60	EPAL	80 x 120 x 75h
20 x 120 Nat	4	0,96	18,60	60	57,60	1.136	EPAL	80 x 120 x 75h
60 x 60	3	1,08	21	40	43,20	840	EPAL	80 x 120 x 75h
30 x 60 Nat	7	1,26	24	48	60,48	1.152	EPAL	80 x 120 x 75h
30 x 60 Lap	6	1,08	21	40	43,20	840	EPAL	80 x 120 x 75h
DECORI. DECORS								
MOSAICO 30 x 30	6	0,54	13,23	54	29,16	714,42	EPAL	80 x 120 x 73h



	PCS/BOX	MQ/BOX	KG/BOX	PACKING	PACKING SIZE
8,8 mm					
BATTISCOPA 6,5 x 120	6	0,47	10,55	EPAL	80 x 120
GRADINO COSTA RETTA 33 x 120 x 3,2h **	2	-	23,00	EPAL	80 x 120
GRADINO COSTA RETTA 33 x 120 x 3,2h Sx/Dx**	1	-	13,00	EPAL	80 x 120
GRADINO COSTA RETTA 33 x 60 x 3,2h **	4	-	20,00	EPAL	80 x 120
GRADINO COSTA RETTA 33 x 60 x 3,2h Sx/Dx **	2	-	11,00	EPAL	80 x 120

** A disposizione solo su richiesta. Tempi di consegna: 30gg
Available upon request only. Delivery terms: 30 days
Disponible seulement sur requête. Délais de livraison: 30 jours
Verfügbar auf Anfrage. Lieferzeit: 30 Tage



Cotto del Casale

Cotto del Casale
MATERICO

BRUNO

ROSADO

OCRA

GREIGE



ISO 13006 - G - Bla_E ≤ 0,5% - UNI EN 14411 - GL
ANSI A - 326.3: 2021
WET DYNAMIC COEFFICIENT OF FRICTION | DCOF ≥ 0,42



Cotto del Casale
MATERICO

8,8 mm



60,9x60,9
24"x24"
Nat



40,6x60,9
16"x24"
Nat



40,6x40,6
16"x16"
Nat



20,3x40,6
8"x16"
Nat



20,3x20,3
8"x8"
Nat

modular system

Decori / Decors



Capri 20,3x20,3
8"x8"
Lucido



Pompei 20,3x20,3
8"x8"
Satinato



Pompei Fascia 10x40,6
4"x16"
Satinato

8,8 mm OUTDOOR R11C



60,9x60,9
24"x24"
Nat



40,6x60,9
16"x24"
Nat



40,6x40,6
16"x16"
Nat



20,3x40,6
8"x16"
Nat



20,3x20,3
8"x8"
Nat

modular system

Rosado, Bruno

Sviluppo grafico per formato
Pattern by size
Développement graphique par format
Grafischer Entwurf für Format



60,9x60,9
8,8 mm
16

40,6x60,9
8,8 mm
27

40,6x40,6
8,8 mm
35

20,3x40,6
8,8 mm
55

20,3x20,3
8,8 mm
55

Sviluppo Grafico e Modularità

Pattern by size and modular system. Développement graphique par format et système modulaire.
Grafische Entwicklung und Modularität



Rosado
60,9x60,9
24"x24"
25%

40,6x60,9
16"x24"
33,5%

40,6x40,6
16"x16"
22,2%

20,3x40,6
8"x16"
11%

20,3x20,3
8"x8"
8,3%

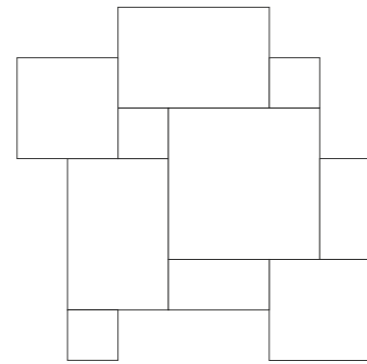

Decorì

Decors

8,8 mm



Capri 20,3x20,3 *
8"x8"
Lucido



Pompei 20,3x20,3 *
8"x8"
Satinato



Fascia 10x40,6 *
4"x16"
Satinato

*** In ogni scatola la combinazione dei soggetti è del tutto casuale. Lo stesso soggetto potrebbe essere ripetuto oppure potrebbe non essere presente nella scatola.**
Each box contains a random assortment of the designs available. The same design may be repeated and certain designs may not be included in the box.
La combinaison des motifs à l'intérieur de chaque boîte est absolument fortuite. Le même motif pourrait être répété ou ne pas se trouver à l'intérieur de la boîte.
Die Zusammenstellung der Motive ist in jedem Karton vollkommen zufällig. Das selbe Motiv könnte sich wiederholen oder nicht im Karton vorhanden sei



Floor
Rosado 40,6x60,9_16"x24" - 40,6x40,6_16"x16" - 20,3x40,6_8"x16" - 20,3x20,3_8"x8" Nat
Decoro Pompei 20,3x20,3_8"x8" Lucido

Cotto del Casale

8,8 mm

	60,9x60,9 24"x24"	40,6x60,9 16"x24"	40,6x40,6 16"x16"	20,3x40,6 8"x16"	20,3x20,3 8"x8"
	Nat	Nat	Nat	Nat	Nat
BRUNO	161004	161014	161024	161034	161044
ROSADO	161003	161013	161023	161033	161043
OCRA	161002	161012	161022	161032	161042
GREIGE	161001	161011	161021	161031	161041
Price code	M083	M083	M083	M083	M083

8,8 mm

	60,9x60,9 24"x24"	40,6x60,9 16"x24"	40,6x40,6 16"x16"	20,3x40,6 8"x16"	20,3x20,3 8"x8"
	Nat	Nat	Nat	Nat	Nat
BRUNO	161007	161016	161027	161037	161047
ROSADO	161006	161015	161026	161036	161046
Price code	M083	M083	M083	M083	M083

8,8 mm

	Capri* 20,3x20,3 8"x8"	Pompei* 20,3x20,3 8"x8"	Pompei Fascia* 10x40,6 4"x12"
	Lucido	Satinato	Satinato
	161302	161301	161303
Price code	CP137	CP107	CP125

Pezzi Speciali / Trims. Pièces speciale. Die Sonderstücke

	Battiscopa Skirting	Gradino costa retta** Straight nosed stair**	Gradino costa retta SX - DX** Straight-edge step L-R
	7x60,9	33x60,9	33x60,9
	Nat	Nat	Nat
BRUNO	161104	161204	161224SX 161214DX
ROSADO	161103	161203	161223SX 161213DX
OCRA	161102	161202	161222SX 161212DX
GREIGE	161101	161201	161221SX 161211DX
Price code	P021	P135	P167

8,8 mm

	Elle monolitico estruso** Extruded L-shaped monoblock tile
	15x30x4
	Nat
BRUNO	161404
ROSADO	161403
Price code	P050



Floor
Greige 60,9x60,9_24"x24" - 40,6x40,6_16"x16" - 20,3x40,6_8"x16" - 20,3x20,3_8"x8" Nat

Imballi / Packings. Emballage. Verpackung

8,8 mm	PCS/BOX	MQ/BOX	KG/BOX	BOX/PAL	MQ/PAL	KG/PAL	PACKING	PACKING SIZE
60,9 x 60,9	3	1,11	20,60	40	44,40	824	EPAL	80 x 120 x 75h
60,9 x 60,9 R11	3	1,11	20,60	40	44,40	824	EPAL	80 x 120 x 75h
40,6 x 60,9	6	1,48	31,60	40	59,20	1.264	EPAL	80 x 120 x 96h
40,6 x 60,9 R11	6	1,48	31,60	40	59,20	1.264	EPAL	80 x 120 x 96h
40,6 x 40,6	6	0,99	21,63	72	71,28	1.558	EPAL	80 x 120 x 96h
40,6 x 40,6 R11	6	0,99	21,63	72	71,28	1.558	EPAL	80 x 120 x 96h
20,3 x 40,6	13	1,07	23,38	72	77,04	1.684	EPAL	80 x 120 x 96h
20,3 x 40,6 R11	13	1,07	23,38	72	77,04	1.684	EPAL	80 x 120 x 96h
20,3 x 20,3	30	1,24	27,09	60	74,40	1.626	EPAL	80 x 120 x 96h
20,3 x 20,3 R11	30	1,24	27,09	60	74,40	1.626	EPAL	80 x 120 x 96h
DECORI. DECORS								
CAPRI 20,3 x 20,3 *	6	0,24	5,65	-	-	-	EPAL	80 x 120
POMPEI 20,3 x 20,3 *	4	0,16	4,05	-	-	-	EPAL	80 x 120
FASCIA 10 x 40,6 *	4	0,16	4,10	-	-	-	EPAL	80 x 120

8,8 mm	PCS/BOX	MQ/BOX	KG/BOX	BOX/PAL	MQ/PAL	KG/PAL	PACKING	PACKING SIZE
BATTISCOPA 7 x 60,9	15	0,63	13,76	-	-	-	EPAL	80 x 120
GRADINO COSTA RETTA 33 x 60,9 x 3,2h **	4	-	20	-	-	-	EPAL	80 x 120
GRADINO COSTA RETTA 33 x 60,9 x 3,2h SX/DX **	2	-	11	-	-	-	EPAL	80 x 120
ELLE MONOLITICO ESTRUSO 15 x 30 x 4h **	8	0,32	10,40	44	14,08	477,60	EPAL	80 x 120 x 75h

* Articolo venduto a composizione. In ogni scatola la combinazione dei soggetti è del tutto casuale. Lo stesso soggetto potrebbe essere ripetuto oppure potrebbe non essere presente nella scatola.

Item sold by composition. Each box contains a random assortment of the designs available. The same design may be repeated and certain designs may not be included in the box.

Article vendu par composition. La combinaison des motifs à l'intérieur de chaque boîte est absolument fortuite. Le même motif pourrait être répété ou ne pas se trouver à l'intérieur de la boîte.

Der artikel wird als komposition verkauft. Die Zusammenstellung der Motive ist in jedem Karton vollkommen zufällig. Das selbe Motiv könnte sich wiederholen oder nicht im Karton vorhanden sein.

** A disposizione solo su richiesta. Tempi di consegna: 30gg. Available upon request only. Delivery terms: 30 days. Disponible seulement sur requête. Délais de livraison: 30 jours. Verfügbar auf Anfrage. Lieferzeit: 30 Tage



Up
MATERICO

Up

BLACK

GREY

WHITE

BONE

AVANA

GREEN

BLUE



UNI EN 14411 - ISO 13006 B III a - GL
Pasta bianca / White body / Pâte blanche / Weißscherbüg

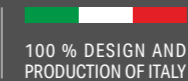

Up
MATERICO

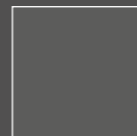

10x10
4"x4"
Matte
Glossy



Cuscino 10x10
4"x4"
Matte
Glossy

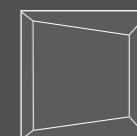

Lingotto 10x10
4"x4"
Matte
Glossy



5x25
2"x10"
Matte
Glossy

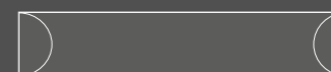

Cuscino 5x25
2"x10"
Matte
Glossy



Lingotto 5x25
2"x10"
Matte
Glossy



Cannettato 5x25
2"x10"
Matte
Glossy



Jolly 1,2x20
1/2"x8"
Matte
Glossy



Da rivestimento.
Wall tile. Pour revêtement. Für Wandbelag.



Wall
Black Cuscino 5x25_2'x10" Glossy

Counter Top
Le Malte Sage Nat Ret



Wall
White Cuscino 10x10_4"x4" Matte











Furniture
Statuario Lap





Wall
Green Lingotto 5x25_2"x10" Glossy
Green 5x25_2"x10" Matte

 **Da rivestimento.**
Wall tile. Pour revêtement. Für Wandbelag.

9 mm













				
	10x10 4"x4"	10x10 4"x4"	5x25 2"x10"	5x25 2"x10"
	Matte	Glossy	Matte	Glossy
BLACK 	192002	192012	192062	192072
GREY 	192003	192013	192063	192073
WHITE 	192001	192011	192061	192071
BONE 	192004	192014	192064	192074
AVANA 	192005	192015	192065	192075
GREEN 	192006	192016	192066	192076
BLUE 	192007	192017	192067	192077
Price code	M097	M097	M097	M097











	Jolly 1,2x20 ½"x8"	Jolly 1,2x20 ½"x8"
	Matte	Glossy
	192142	192152
	192143	192153
	192141	192151
	192144	192154
	192145	192155
	192146	192156
	192147	192157
Price code	P018	P018

 **Da rivestimento.**
Wall tile. Pour revêtement. Für Wandbelag.

15 mm

						
	Cuscino 5x25 2"x10"	Cuscino 5x25 2"x10"	Cannettato 5x25 2"x10"	Cannettato 5x25 2"x10"	Lingotto 5x25 2"x10"	Lingotto 5x25 2"x10"
	Matte	Glossy	Matte	Glossy	Matte	Glossy
BLACK 	192102	192112	192122	192132	192082	192092
GREY 	192103	192113	192123	192133	192083	192093
WHITE 	192101	192111	192121	192131	192081	192091
BONE 	192104	192114	192124	192134	192084	192094
AVANA 	192105	192115	192125	192135	192085	192095
GREEN 	192106	192116	192126	192136	192086	192096
BLUE 	192107	192117	192127	192137	192087	192097
Price code	M109	M109	M109	M109	M109	M109

15 mm

				
	Lingotto 10x10 4"x4"	Lingotto 10x10 4"x4"	Cuscino 10x10 4"x4"	Cuscino 10x10 4"x4"
	Matte	Glossy	Matte	Glossy
BLACK 	192022	192032	192042	192052
GREY 	192023	192033	192043	192053
WHITE 	192021	192031	192041	192051
BONE 	192024	192034	192044	192054
AVANA 	192025	192035	192045	192055
GREEN 	192026	192036	192046	192056
BLUE 	192027	192037	192047	192057
Price code	M109	M109	M109	M109

I rivestimenti hanno bordi naturali. Per ottenere un miglior risultato estetico si consigliano fughe di minimo 2 mm ed una compensazione tra i diversi elementi in fase di installazione, se necessario.

These tiles have natural edges. To obtain the best aesthetic result, we suggest joints of at least 2 mm and, if necessary, a compensation between the different elements during installation.

Les revêtements présentent des bords naturels. Pour un plus bel effet esthétique, nous conseillons des joints de 2 mm d'épaisseur minimum et une compensation entre les divers éléments durant la pose si nécessaire.

Die Fliesen haben natürliche Kanten. Für ein besseres ästhetisches Ergebnis empfehlen wir Stöße bzw. Fugen mit mindestens 2 mm Breite und gegebenenfalls einen Ausgleich zwischen den verschiedenen Elementen bei der Verlegung.

Imballi / Packings. Emballage. Verpackung

	PCS/BOX	MQ/BOX	KG/BOX	BOX/PAL	MQ/PAL	KG/PAL	PACKING	PACKING SIZE	TARE (KG)
9 mm									
10 x 10	50	0,50	8,28	120	60	994	EPAL	80 x 120	22
5 x 25	44	0,55	9,32	112	61,6	1.044	EPAL	80 x 120	22
JOLLY 1,2 x 20	22	0,05	0,86	-	-	-	EPAL	80 x 120	22
15 mm									
LINGOTTO 10 x 10	42	0,42	7,5	120	50,4	900	EPAL	80 x 120	22
CUSCINO 10 x 10	42	0,42	7,3	120	50,4	876	EPAL	80 x 120	22
LINGOTTO 5 x 25	36	0,45	6,2	112	50,4	694	EPAL	80 x 120	22
CUSCINO 5 x 25	32	0,40	6,2	112	44,8	694	EPAL	80 x 120	22
CANNETTATO 5 x 25	34	0,43	6,1	112	48,2	683	EPAL	80 x 120	22



Small



Small
MATERICO



V3
SHADESPECTRUM
HIGH

UNI EN 14411 - ISO 13006 B III a - GL
Pasta bianca / White body / Pâte blanche / Weißscherbis

100 % DESIGN AND
PRODUCTION OF ITALY

Small
MATERICO

9 mm

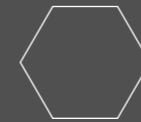

12,4x10,7
5"x4 1/4"
Glossy



10x10
4"x4"
Glossy



6,5x20
2 1/2"x8"
Glossy



5,1x16,1
2"x6 1/3"
Glossy



Jolly 1,2x20
1/2"x8"
Glossy



Pencil bullnose 3x20
1 1/4"x8"
Glossy

Trend



12,4x10,7
5"x4 1/4"
Glossy

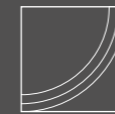

Arco 10x10
4"x4"
Glossy

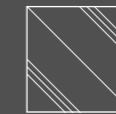

Diagonal 10x10
4"x4"
Glossy



5,1x16,1
2"x6 1/3"
Glossy



Sun 6,5x20
2 1/2"x8"
Glossy



Rhombus 6,5x20
2 1/2"x8"
Glossy

Amalfi

15
PATTERNS



12,4x10,7
5"x4 1/4"
Glossy

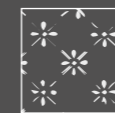

10x10
4"x4"
Glossy



6,5x20
2 1/2"x8"
Glossy



5,1x16,1
2"x6 1/3"
Glossy



Da rivestimento.
Wall tile. Pour revêtement. Für Wandbelag.

Trend

9 mm

BEIGE



OCHER



BLACK



LIGHT BLUE



NAVY



12,4x10,7
5"x4 1/4"
Glossy

Arco 10x10
4"x4"
Glossy

Diagonal 10x10
4"x4"
Glossy

Rhombus 6,5x20
2 1/2"x8"
Glossy

Sun 6,5x20
2 1/2"x8"
Glossy

5,1x16,1
2"x6 1/3"
Glossy



Wall
Light Blue 10x10_4"x4" Glossy

Furniture
Trend Arco Light Blue 10x10_4"x4" Glossy
Prune 10x10_4"x4" Glossy

Amalfi

9 mm

12,4x10,7
5"x4¼"
Glossy

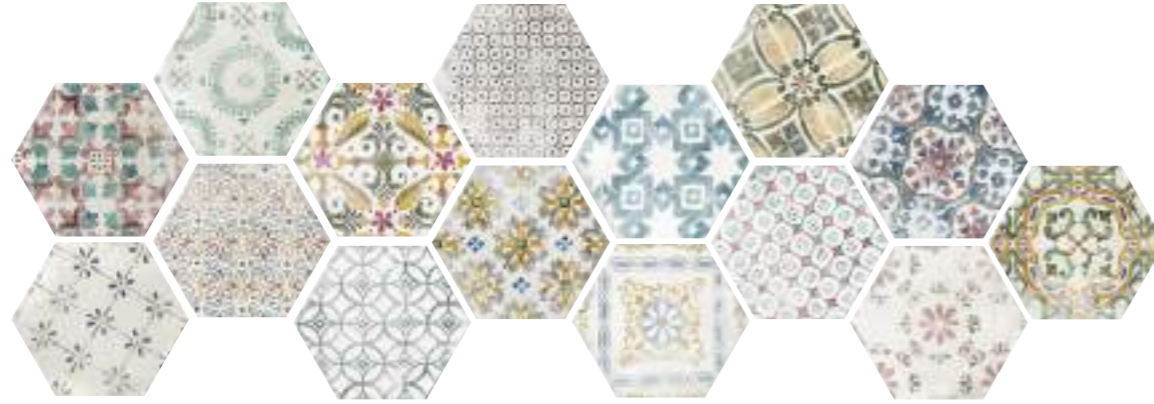

10x10
4"x4"
Glossy



6,5x20
2½"x8"
Glossy



5,1x16,1
2"x6½"
Glossy













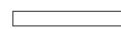

Backsplash
White 12,4x10,7 5"x4¼" Glossy
Amalfi 12,4x10,7 5"x4¼" Glossy

Furniture
Ocher 10x10_4"x4" Glossy

Small

 **Da rivestimento.**
Wall tile. Pour revêtement. Für Wandbelag.

	9 mm					
	 12,4x10,7 5"x4¼"	 10x10 4"x4"	 6,5x20 2½"x8"	 5,1x16,1 2"x6½"	 Jolly 1,2x20 ½"x8"	 Pencil bullnose 3x20 1¼"x8"
	Glossy					
WHITE 	180048	180068	180008	180028	180088	180108
BLACK 	180041	180061	180001	180021	180081	180101
GREY 	180053	180073	180013	180033	180093	180113
NAVY 	180042	180062	180002	180022	180082	180102
PRUSSIAN 	180043	180063	180003	180023	180083	180103
LIGHT BLUE 	180047	180067	180007	180027	180087	180107
SAGE 	180046	180066	180006	180026	180086	180106
EMERALD 	180044	180064	180004	180024	180084	180104
FLAMINGO 	180049	180069	180009	180029	180089	180109
BEIGE 	180050	180070	180010	180030	180090	180110
OCHER 	180051	180071	180011	180031	180091	180111
PRUNE 	180052	180072	180012	180032	180092	180112
Price code	M131	M097	M093	M131	P018	P011

	9 mm			
	 12,4x10,7 5"x4¼"	 10x10 4"x4"	 6,5x20 2½"x8"	 5,1x16,1 2"x6½"
	Glossy			
AMALFI *	180256	180241	180206	180221
Price code	M141	M109	M105	M141

Le tonalità di Amalfi e Trend sono compatibili con i colori dei fondi a tinta unita.

Amalfi and Trend shade could be similar as the plain colour pieces.

Les nuances concernantes Amalfi et Trend sont compatibles avec les fonds.

Die Farbtöne von Amalfi und Trend sind vereinbaren mit die Unifliesen.

I rivestimenti hanno bordi naturali. Per ottenere un miglior risultato estetico si consigliano fughe di minimo 2 mm ed una compensazione tra i diversi elementi in fase di installazione, se necessario.

These tiles have natural edges. To obtain the best aesthetic result, we suggest joints of at least 2 mm and, if necessary, a compensation between the different elements during installation.

Les revêtements présentent des bords naturels. Pour un plus bel effet esthétique, nous conseillons des joints de 2 mm d'épaisseur minimum et une compensation entre les divers éléments durant la pose si nécessaire.



Die Fliesen haben natürliche Kanten. Für ein besseres ästhetisches Ergebnis empfehlen wir Stöße bzw. Fugen mit mindestens 2 mm Breite und gegebenenfalls einen Ausgleich zwischen den verschiedenen Elementen bei der Verlegung.

*** In ogni scatola la combinazione dei soggetti è del tutto casuale. Lo stesso soggetto potrebbe essere ripetuto oppure potrebbe non essere presente nella scatola.**

Each box contains a random assortment of the designs available. The same design may be repeated and certain designs may not be included in the box.

La combinaison des motifs à l'intérieur de chaque boîte est absolument fortuite. Le même motif pourrait être répété ou ne pas se trouver à l'intérieur de la boîte.

Die Zusammenstellung der Motive ist in jedem Karton vollkommen zufällig. Das selbe Motiv könnte sich wiederholen oder nicht im Karton vorhanden sein.

	9 mm					
	 12,4x10,7 5"x4¼"	 Arco 10x10 4"x4"	 Diagonal 10x10 4"x4"	 Rhombus 6,5x20 2½"x8"	 Sun 6,5x20 2½"x8"	 5,1x16,1 2"x6½"
	Glossy					
TREND BEIGE 	180251	180232	180231	180212	180201	180211
TREND OCHER 	180253	180236	180235	180216	180203	180215
TREND BLACK 	180252	180234	180233	180214	180202	180213
TREND LIGHT BLUE 	180254	180238	180237	180218	180204	180217
TREND NAVY 	180255	180240	180239	180220	180205	180219
Price code	M141	M109	M109	M105	M105	M141

Imballi / Packings. Emballage. Verpackung

	PCS/BOX	MQ/BOX	KG/BOX	BOX/PAL	MQ/PAL	KG/PAL	PACKING	PACKING SIZE
9 mm								
12,4 x 10,7	50	0,50	7,68	84	42	665	EPAL	80 x 120
10 x 10	50	0,50	7,23	120	60	887	EPAL	80 x 120
6,5 x 20	38	0,50	7,75	120	60	950	EPAL	80 x 120
5,1 x 16,1	66	0,54	7,95	120	64,80	974	EPAL	80 x 120
JOLLY 1,2 x 20	22	0,05	0,88	-	-	-	EPAL	80 x 120
PENCIL BULLNOSE 3 x 20	15	0,09	1,73	-	-	-	EPAL	80 x 120



Legno

Honey Wood	369
Il Cerreto	387
Amazon	395
Ca' Foscari	403
Kauri	411



Honey Wood

LEGNO

*Honey
Wood*

NOCE

ROVERE

OLMO

BRICOLA

LARICE

V2
SHADE SPECTRUM
MODERATE

ISO 13006 - G - Bla_E ≤ 0,5% - UNI EN 14411 - UGL
ANSI A - 326.3: 2021
WET DYNAMIC COEFFICIENT OF FRICTION | DCOF ≥ 0,42

100 % DESIGN AND
PRODUCTION OF ITALY

Honey Wood
LEGNO

6 mm



40x240
16"x96"
Nat Ret



24x240
9 1/2"x96"
Nat Ret

8,8 mm R10B



30x120
12"x48"
Nat Ret



20x120
8"x48"
Nat Ret



7,5x40,7
3"x16"
Nat

— modular system —

Decori / Decors



Tapparella 20x120
8"x48"
Nat Ret



Spina 30x34
12"x13 1/2"
Nat Ret



Rigato 30x30
12"x12"
Nat Ret

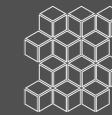

Rombo 30x35
12"x13 3/4"
Nat Ret



Inciso 30x30
12"x12"
Nat Ret

8,8 mm OUTDOOR R11C



20x120
8"x48"
Nat Ret

20 mm OUTDOOR R11C



40x120
16"x48"
Nat Ret

Sviluppo grafico per formato
Pattern by size
Développement graphique par format
Grafischer Entwurf für Format



40x240
6 mm
9

24x240
6 mm
15

30x120
8,8 mm
24

20x120
8,8 mm
36

40x120
20 mm
15

Sviluppo Grafico

Pattern by size. Développement graphique par format. Grafischer Entwurf für Format.

Honey Wood
LEGNO

NOCE 40x240 6 mm

9 patterns



ROVERE 40x240 6 mm

9 patterns



Sviluppo Grafico

Pattern by size. Développement graphique par format. Grafischer Entwurf für Format.

Honey Wood
LEGNO

OLMO 24x240 6 mm

15 patterns



BRICOLA 30x120 8,8 mm

24 patterns



Sviluppo Grafico

Pattern by size. Développement graphique par format. Grafischer Entwurf für Format.

LARICE 20x120 8,8 mm

36 patterns



Backsplash
Tapparella 20x120_8"x48" Nat Ret

Counter top
Breccia Argentum Lap

Floor
Larice 30x120_12"x48" Nat Ret



Floor
Chevron Mix 7,5x40,7_3"x16" Nat

Sviluppo Grafico

Pattern by size. Développement graphique par format. Grafischer Entwurf für Format.

CHEVRON MIX 7,5x40,7 8,8 mm



* Mix di 4 Essenze
**Honey Wood: Rovere,
Noce, Bricola e Olmo**
Mix of the 4 Honey Wood
Essences: Rovere, Noce,
Bricola and Olmo
Mélange de 4 essences
Honey Wood: Rovere, Noce,
Bricola et Olmo
Mischung aus 4 Honey
Wood Essenzen: Rovere,
Noce, Bricola und Olmo

Decori

Decors

Honey Wood

LEGNO

8,8 mm R10B



Inciso 30x30 **
12"x12"
Nat Ret



Rombo 30x35 **
12"x13 3/4"
Nat Ret



Rigato 30x30 **
12"x12"
Nat Ret



Spina 30x34 **
12"x13 1/2"
Nat Ret

**** Decoro realizzato con il Mix delle 5 Essenze Honey Wood e la serie Statuario.**
Decoration made with the Mix of the 5 Honey Wood Essences and the Statuario series.
Décoration réalisée avec le mélange des 5 Essences Honey Wood et la série Statuario.
Dekor erstellt mit der Mischung der 5 Honey Wood Essenzen und der Serie Statuario.



Tapparella 20x120 *
8"x48"
Nat Ret

*** Decoro realizzato con il Mix delle 5 Essenze Honey Wood e la serie Pierres des Châteaux Chambord.**
Decoration made with the Mix of the 5 Honey Wood Essences and the series Pierres des Châteaux Chambord.
Décoration réalisée avec le mélange des 5 Essences Honey Wood et la série Pierres des Châteaux Chambord.
Dekor erstellt mit der Mischung der 5 Honey Wood Essenzen und der Serie Pierres des Châteaux Chambord.

Wall
Tapparella 20x120_8"x48" Nat Ret

Furniture
Sahara Noir Lap

Sviluppo Grafico

Pattern by size. Développement graphique par format. Grafischer Entwurf für Format.

OUTDOOR MIX 40x120

20 mm R11C



15 patterns

Mix di 3 Essenze Honey Wood:
Rovere, Bricola e Olmo
Mix of the 3 Honey Wood Essences:
Rovere, Bricola and Olmo
Mélange de 3 essences Honey
Wood: Rovere, Bricola et Olmo
Mischung aus 3 Honey Wood
Essenzen: Rovere, Bricola und Olmo



Floor
Outdoor Mix 40x120_16"x48" Nat Ret

Honey Wood

6 mm		8,8 mm		7,5x40,7	
R10B		R10B		Nat	
40x240 16"x96"	24x240 9 1/2"x96"	30x120 12"x48"	20x120 8"x48"	7,5x40,7 3"x16"	
Nat Ret	Nat Ret	Nat Ret	Nat Ret	Nat	
NOCE	191013	191003	NOCE	191033	191023
ROVERE	191011	191001	ROVERE	191031	191021
LARICE	191012	191002	LARICE	191032	191022
BRICOLA	191014	191004	BRICOLA	191034	191024
OLMO	191015	191005	OLMO	191035	191025
Price code	M141	M141	Price code	M093	M093

7,5x40,7		MIX	
Nat		4 ESSENZE	
7,5x40,7 3"x16"		MIX 4 ESSENZE (BRICOLA, OLMO, ROVERE, NOCE)	191047
		Price code	M107

Pezzi Speciali / Trims. Pièces speciale. Die Sonderstücke

20 mm		20 mm		Gradone**		Gradone Angolo Sx/Dx**	
R11C		R11C		Large step		Large step - Corner L/R	
40x120 16"x48"		40x120	40x120				
Nat Ret		Costa toro Nat Ret	Costa retta Nat Ret	Costa toro Nat Ret	Costa retta Nat Ret		
MIX 3 ESSENZE (BRICOLA, OLMO, ROVERE)	191046	MIX 5 ESSENZE	191099	191096	191100 SX 191101 DX	191097 SX 191098 DX	
Price code	M131	Price code	P219	P211	P251	P239	

8,8 mm					
R10B					
Rigato*	Inciso*	Spina*	Rombo*	Tapparella***	
30x30 12"x12"	30x30 12"x12"	30x34 12"x13 1/2"	30x35 12"x13 3/4"	20x120 8"x48"	
Nat Ret	Nat Ret	Nat Ret	Nat Ret	Nat Ret	
MIX 5 ESSENZE	191049	191050	191044	191045	191048
Price code	M189	M215	M189	M201	M153

Pezzi Speciali / Trims. Pièces speciale. Die Sonderstücke

8,8 mm		8,8 mm		14 h	
R11C		R10B		14 h	
20x120 8"x48"		Battiscopa Skirting	Gradino costa retta** Straight nosed stair**	Gradino costa retta SX - DX** Straight-edge step L-R	
Nat Ret		6,5x120	30x120	30x120	
NOCE	191053	NOCE	191063	191083 SX 191093 DX	
ROVERE	191051	ROVERE	191061	191081SX 191091 DX	
LARICE	191052	LARICE	191062	191082 SX 191092 DX	
BRICOLA	191054	BRICOLA	191064	191084 SX 191094 DX	
OLMO	191055	OLMO	191065	191085 SX 191095 DX	
Price code	M093	Price code	P040	P207	P231

Imballi / Packings. Emballage. Verpackung

	PCS/BOX	MQ/BOX	KG/BOX	PCS/PAL	BOX/PAL	MQ/PAL	KG/PAL	PACKING	PACKING SIZE	TARE (KG)
6 mm										
40 x 240	-	-	-	36	-	34,56	536	CASSA LEGNO	252 x 94 x 30,4h	85
24 x 240	-	-	-	54	-	31,32	482	CASSA LEGNO	252 x 94 x 30,4h	85
8,8 mm										
30 x 120	3	1,08	21	135	45	48,6	926	EPAL	80 x 120 x 75h	22
20 x 120	4	0,96	18,6	240	60	57,6	1.116	EPAL	80 x 120 x 75h	22
20 x 120 R11	4	0,96	18,6	240	60	57,6	1.116	EPAL	80 x 120 x 75h	22
CHEVRON 7,5 x 40,7	14DX - 14SX	0,88	15,83	1.176	42	36,96	667	EPAL	80 x 120 x 75h	22
DECORI. DECORS										
RIGATO 30 x 30 *	6	0,54	10,80	360	60	32,40	648	EPAL	80 x 120 x 75h	22
INCISO 30 x 30 *	6	0,54	10,80	360	60	32,40	648	EPAL	80 x 120 x 75h	22
SPINA 30 x 34 *	6	0,61	11,10	360	60	36,60	666	EPAL	80 x 120 x 75h	22
ROMBO 30 x 35 *	6	0,63	12,50	360	60	37,80	750	EPAL	80 x 120 x 75h	22
TAPPARELLA 20 x 120 ***	4	0,96	18,60	120	30	28,80	558	EPAL	80 x 120 x 75h	22
20 mm										
40 x 120	2	0,96	44,6	48	24	23,04	1.070	EPAL	80 x 120 x 75h	22

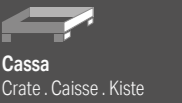

PEZZI SPECIALI. TRIMS	PCS/BOX	MQ/BOX	KG/BOX	PACKING	PACKING SIZE	TARE (KG)
8,8 mm						
BATTISCOPA 6,5 x 120	6	0,46	11	EPAL	80 x 120	22
GRADINO COSTA RETTA 30 x 120 x 4h **	2	-	20,7	EPAL	80 x 120	22
GRADINO COSTA RETTA 30 x 120 x 4h SX/DX **	1	-	10,8	EPAL	80 x 120	22
20 mm						
GRADONE 40 x 120 **	1	-	22,5	EPAL	80 x 120	22
GRADONE 40 x 120 SX/DX **	1	-	22,5	EPAL	80 x 120	22

**** A disposizione solo su richiesta. Tempi di consegna: 30gg**
Available upon request only. Delivery terms: 30 days
Disponible seulement sur requête. Délais de livraison: 30 jours
Verfügbar auf Anfrage. Lieferzeit: 30 Tage

* Decoro realizzato con il Mix delle 5 Essenze Honey Wood e la serie Statuario.
Decoration made with the Mix of the 5 Honey Wood Essences and the Statuario series.
Décoration réalisée avec le mélange des 5 Essences Honey Wood et la série Statuario.
Dekor erstellt mit der Mischung der 5 Honey Wood Essenzen und der Serie Statuario.

*** Decoro realizzato con il Mix delle 5 Essenze Honey Wood e la serie Pierres des Châteaux Chambord.
Decoration made with the Mix of the 5 Honey Wood Essences and the series Pierres des Châteaux Chambord.
Décoration réalisée avec le mélange des 5 Essences Honey Wood et la série Pierres des Châteaux Chambord.
Dekor erstellt mit der Mischung der 5 Honey Wood Essenzen und der Serie Pierres des Châteaux Chambord.

Il Cer reto



Il Cerreto

LEGNO

PINOT GRIGIO

CHAMPAGNE

SOAVE

CHARDONNAY

AMARONE

V2
SHADE SPECTRUM
MODERATE

ISO 13006 - G - Bla_E ≤ 0,5% - UNI EN 14411 - GL
ANSI A - 326.3: 2021
WET DYNAMIC COEFFICIENT OF FRICTION | DCOF ≥ 0,42

100 % DESIGN AND
PRODUCTION OF ITALY

Il Cerreto
LEGNO

8,8 mm R10B



23,4x148
9 1/8"x58 1/4"
Nat Ret



30x120
12"x48"
Nat Ret



20x120
8"x48"
Nat Ret

Decoro / Decor

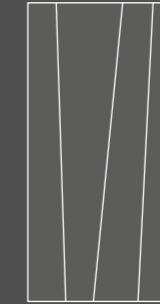

4
PATTERNS

Chrome 60x120
24"x48"
Nat Ret



Rete esagonale 30x26
12"x10 1/4"
Nat Ret

modular system

8,8 mm OUTDOOR R11C

(Champagne - Chardonnay)



20x120
8"x48"
Nat Ret

20 mm OUTDOOR R11C



40x120
16"x48"
Nat Ret

Formati disponibili con la tecnologia ADVANCE®. Per info consulta pag. 457.

ADVANCE® technology available sizes. For more info go to page 457.

Formats disponibles avec la technologie ADVANCE®. Pour toutes informations aller à la page 457.

Verfügbare Größen mit ADVANCE®-Technologie. Für weitere Infos siehe S. 457.

Sviluppo grafico per formato
Pattern by size
Développement graphique par format
Grafischer Entwurf für Format



23,4x148
8,8 mm

21

30x120
8,8 mm

14

20x120
8,8 mm

21

40x120
20 mm

12

Sviluppo Grafico

Pattern by size. Développement graphique par format. Grafischer Entwurf für Format

CHARDONNAY 20x120 8,8 mm

21 patterns



Decori

Decors

8,8 mm R10B

PINOT GRIGIO



White 30x26 *
12"x10 1/4"

CHAMPAGNE



White 30x26 *
12"x10 1/4"



Grey 30x26 *
12"x10 1/4"



Black 30x26 *
12"x10 1/4"

CHARDONNAY



Beige 30x26 *
12"x10 1/4"

AMARONE



Brown 30x26 *
12"x10 1/4"

* Decoro realizzato con la serie Pierres des Châteaux e Il Cerreto.
Decoration made with Pierres des Châteaux and Il Cerreto series.
Décor composé de Pierres des Châteaux et Il Cerreto séries.
Dekor mit der Serie Pierres des Châteaux und Il Cerreto ausgeführt.



Chrome 60x120
24"x48"
Nat Ret

4 patterns

Il Cerreto

8,8 mm

R10B

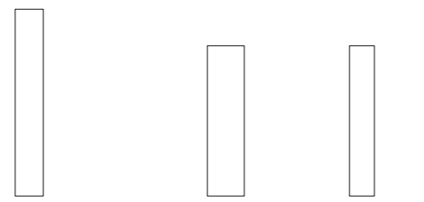

	23,4x148 9 1/8"x58 1/4"		30x120 12"x48"	20x120 8"x48"
	Nat Ret	Nat Ret	Nat Ret	Nat Ret
PINOT GRIGIO	157028	157049	157013	157023
CHAMPAGNE	157029	157050	157014	157024
SOAVE	157027	157048	157012	157022
CHARDONNAY	157025	157046	157010	157020
AMARONE	157026	157047	157011	157021
Price code	M101	M119	M093	M093

8,8 mm

R11C



	20x120 8"x48"	40x120 16"x48"
	Nat Ret	Nat Ret
PINOT GRIGIO	-	157033
CHAMPAGNE	157054	157034
SOAVE	-	-
CHARDONNAY	157055	157030
AMARONE	-	157031
Price code	M093	M131

8,8 mm

R10B



Rete esagonale*
30x26
12"x10 1/4"

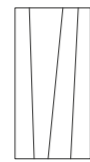

Chrome
60x120
24"x48"

	Nat Ret	Nat Ret
PINOT GRIGIO	MOSCP01	
CHAMPAGNE	MOSCP04 MOSCP05 MOSCP06	
SOAVE	-	157090
CHARDONNAY	MOSCP02	
AMARONE	MOSCP03	
Price code	M287	M097

Formati disponibili con la tecnologia ADVANCE®. Per info consulta pag. 457.
ADVANCE® technology available sizes. For more info go to page 457.
Formats disponibles avec la technologie ADVANCE®. Pour toutes informations aller à la page 457.
Verfügbare Größen mit ADVANCE®-Technologie. Für weitere Infos siehe S. 457.

Pezzi Speciali / Trims. Pièces speciale. Die Sonderstücke

8,8 mm

R10B



Battiscopa
Skirting

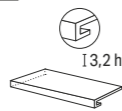

Gradino costa retta**
Straight nosed stair**

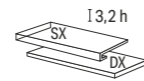

Gradino costa retta SX - DX**
Straight-edge step L-R

20 mm

R11C



Gradone
costa toro**
Large step

	6,5x120		6,5x148		33x120		33x120	
	Nat Ret	Nat Ret	Nat Ret	Nat Ret	Nat Ret	Nat Ret	Nat Ret	
PINOT GRIGIO	157104	157114	157204	157209	157224 SX 157214 DX	157219 DX 157229 SX		
CHAMPAGNE	157101	157111	157201	157206	157221 SX 157211 DX	157216 DX 157226 SX		
SOAVE	157102	157112	157202	157207	157222 SX 157212 DX	157217 DX 157227 SX		
CHARDONNAY	157103	157113	157203	157208	157223 SX 157213 DX	157218 DX 157228 SX		
AMARONE	157105	157115	157205	157210	157225 SX 157215 DX	157220 DX 157230 SX		
Price code	P040	P046	P207	P235	P231	P282		

40x120

	Nat Ret
PINOT GRIGIO	157404
CHAMPAGNE	157401
SOAVE	-
CHARDONNAY	157403
AMARONE	157405
Price code	P219

Imballi / Packings. Emballage. Verpackung

	PCS/BOX	MQ/BOX	KG/BOX	BOX/PAL	MQ/PAL	KG/PAL	PACKING	PACKING SIZE
8,8 mm								
23,4 x 148	3	1,04	20,75	48	49,92	1.016	PALLET	152 x 77,6 x 16,1h
30 x 120	3	1,08	22,50	40	43,20	920	EPAL	80 x 120 x 75h
20 x 120	4	0,96	20,32	60	57,60	1.239	EPAL	80 x 120 x 75h
20 x 120 R11	4	0,96	20,32	60	57,60	1.239	EPAL	80 x 120 x 75h
DECORI. DECORS								
CHROME 60 x 120	2	1,44	29,90	32	46,08	977	EPAL	80 x 120 x 75h
RETE ESAGONALE 30 x 26 *	6	0,47	10,74	60	28,20	664	EPAL	80 x 120 x 75h
20 mm								
40 x 120	2	0,96	43,01	24	23,04	1.052	EPAL	80 x 120 x 75h



PEZZI SPECIALI. TRIMS	PCS/BOX	MQ/BOX	KG/BOX	PACKING	PACKING SIZE
8,8 mm					
BATTISCOPA 6,5 x 120	6	-	9,94	EPAL	80 x 120
BATTISCOPA 6,5 x 148	6	-	9,94	EPAL	80 x 120
GRADINO COSTA RETTA 33 x 120 x 3,2h**	2	-	20,70	EPAL	80 x 120
GRADINO COSTA RETTA 33 x 120 x 3,2h SX/DX **	1	-	10,80	EPAL	80 x 120
20 mm					
GRADONE 40 x 120 **	1	-	22,50	EPAL	80 x 120

* Decoro realizzato con la serie Pierres des Châteaux e Il Cerreto.
Décoration made with Pierres des Châteaux and Il Cerreto series.
Décor composé de Pierres des Châteaux et Il Cerreto séries.
Dekor mit der Serie Pierres des Châteaux und Il Cerreto ausgeführt.

** A disposizione solo su richiesta. Tempi di consegna: 30gg
Available upon request only. Delivery terms: 30 days
Disponible seulement sur requête. Délais de livraison: 30 jours
Verfügbar auf Anfrage. Lieferzeit: 30 Tage



Floor
Chardonnay 40x120_16"x48" Nat Ret 20 mm R11

Amazon

LEGNO

Amazon

NAWA

KAMBA

ARARA

MATIS

SURMA

V2
SHADE SPECTRUM
MODERATE

ISO 13006 - G - Bla_E ≤ 0,5% - UNI EN 14411 - GL
ANSI A - 326.3: 2021
WET DYNAMIC COEFFICIENT OF FRICTION | DCOF ≥ 0,42

100 % DESIGN AND
PRODUCTION OF ITALY

Amazon
LEGNO

8,8 mm R10B



20x120
8"x48"
Nat Ret



7,5x40,7
3"x16"
Nat



7,5x45
3"x18"
Nat

20 mm OUTDOOR R11C



40x120
16"x48"
Nat Ret

Sviluppo grafico per formato
Pattern by size
Développement graphique par format
Grafischer Entwurf für Format



20x120
8,8 mm
42

7,5x40,7
8,8 mm
11

7,5x45
8,8 mm
11

40x120
20 mm
14

Sviluppo Grafico

Pattern by size. Développement graphique par format. Grafischer Entwurf für Format.

KAMBA 20x120 8,8 mm

42 patterns



Floor
Matis 20x120_8"x48" Nat Ret

Amazon

8,8 mm

R 10B

	20x120 8"x48"	7,5x40,7 3"x16"	7,5x45 3"x18"
	Nat Ret	Nat	Nat
NAWA	076035	076608	076604
KAMBA	076031	076606	076602
ARARA	076029	076605	076601
MATIS	076033	076607	076603
SURMA	076038	-	-
Price code	M093	M107	M091

20 mm

R 11C

	40x120 16"x48"
	Nat Ret
NAWA	076021
KAMBA	076017
ARARA	076015
MATIS	076019
SURMA	076024
Price code	M131

Pezzi Speciali / Trims. Pièces speciale. Die Sonderstücke

8,8 mm

R 10B

	Battiscopa Skirting	Gradino costa retta** Straight nosed stair**	Gradino costa retta SX - DX** Straight-edge step L-R
	6,5x120	33x120	33x120
	Nat Ret	Nat Ret	Nat Ret
NAWA	076106	076076	076096 SX 076086 DX
KAMBA	076102	076072	076092 SX 076082 DX
ARARA	076100	076070	076090 SX 076080 DX
MATIS	076104	076074	076094 SX 076084 DX
SURMA	076110	076077	076095 SX 076087 DX
Price code	P040	P207	P231

20 mm

R 11C

	Gradone ** Large step		Gradone Angolo Sx/Dx ** Large step - Corner L/R		Griglia ** Drainage grid	Griglia Angolo Sx/Dx ** Drainage grid - Corner L/R
	40x120		40x120		20x60	20x60
	Costa toro Nat Ret	Costa retta Nat Ret	Costa toro Nat Ret	Costa retta Nat Ret		
NAWA	076141	076133	076157 DX 076173 SX	076149 DX 076165 SX	076437	076453 SX 076445 DX
KAMBA	076139	076131	076155 DX 076171 SX	076147 DX 076163 SX	076435	076451 SX 076443 DX
ARARA	076138	076130	076154 DX 076170 SX	076146 DX 076162 SX	076434	076450 SX 076442 DX
MATIS	076140	076132	076156 DX 076172 SX	076148 DX 076164 SX	076436	076452 SX 076444 DX
SURMA	076143	076135	076159 DX 076175 SX	076151 DX 076167 SX	076439	076457 SX 076447 DX
Price code	P219	P211	P251	P239	P205	P205

La gamma completa dei pezzi speciali è disponibile nella "PARTE TECNICA" del catalogo a pag. 493
Our entire range of trims is available in our "TECHNICAL SECTION" of this catalogue pag. 493.
La gamme complète des pièces spéciales est disponible dans la section "PARTIE TECHNIQUE" à la pag. 493 de ce catalogue.
Das komplette Sortiment an Sonderstücken ist in dem "technischen Teil" des Katalogs auf Seite 493 verfügbar.



Floor
Kamba Chevron 7,5x40,7_3"x16" Nat
Kamba Listello 7,5x45_3"x18" Nat

Imballi / Packings. Emballage. Verpackung

	PCS/BOX	MQ/BOX	KG/BOX	BOX/PAL	MQ/PAL	KG/PAL	PACKING	PACKING SIZE
8,8 mm								
20 x 120	4	0,96	17,73	60	57,60	1.084	EPAL	80 x 120 x 75h
CHEVRON 7,5 x 40,7	14DX - 14SX	0,88	15,70	42	36,96	680	EPAL	80 x 120 x 75h
LISTELLO 7,5 x 45	28	0,95	18,20	42	39,9	784	EPAL	80 x 120 x 75h
20 mm								
40 x 120	2	0,96	43,01	24	23,04	1.052	EPAL	80 x 120 x 75h



PEZZI SPECIALI. TRIMS	PCS/BOX	MQ/BOX	KG/BOX	PACKING	PACKING SIZE
8,8 mm					
BATTISCOPA 6,5 x 120	6	-	11,04	EPAL	80 x 120
GRADINO COSTA RETTA 33 x 120 x 3,2h **	2	-	23	EPAL	80 x 120
GRADINO COSTA RETTA 33 x 120 x 3,2h SX/DX **	1	-	12	EPAL	80 x 120
20 mm					
GRADONE 40 x 120 **	1	-	22,50	EPAL	80 x 120
GRADONE 40 x 120 SX/DX **	1	-	22,50	EPAL	80 x 120
GRIGLIA 20 x 60 **	1	-	6,00	EPAL	80 x 120
GRIGLIA 20 x 60 SX/DX **	1	-	6,00	EPAL	80 x 120

** A disposizione solo su richiesta. Tempi di consegna: 30gg
Available upon request only. Delivery terms: 30 days
Disponible seulement sur requête. Délais de livraison: 30 jours
Verfügbar auf Anfrage. Lieferzeit: 30 Tage

*Ca'
Fos
cari*

Ca' Foscari

LEGNO

LINO

CANAPA

AVANA

TABACCO

MORO

V2
SHADE SPECTRUM
MODERATE

ISO 13006 - G - Bla_E ≤ 0,5% - UNI EN 14411 - GL
ANSI A - 326.3: 2021
WET DYNAMIC COEFFICIENT OF FRICTION | DCOF ≥ 0,42

100 % DESIGN AND
PRODUCTION OF ITALY

Ca' Foscari
LEGNO

8,8 mm R10A



20x120
8"x48"
Nat Ret



7,5x40,7
3"x16"
Nat

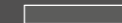

7,5x45
3"x18"
Nat

8,8 mm OUTDOOR R11C



20x120
8"x48"
Nat Ret

20 mm OUTDOOR R11C



40x120
16"x48"
Nat Ret

Sviluppo grafico per formato
Pattern by size
Développement graphique par format
Grafischer Entwurf für Format



20x120
8,8 mm
30

7,5x40,7
8,8 mm
40

7,5x45
8,8 mm
40

40x120
20 mm
12

Ca' Foscari

CANAPA 20x120 8,8 mm

30 patterns



Floor
Moro 40x120_16"x48" Nat Ret 20mm R11

8,8 mm
R10A

	20x120 8"x48"	7,5x40,7 3"x16"	7,5x45 3"x18"
	Nat Ret	Nat	Nat
LINO	094001	094105	094101
CANAPA	094005	094106	094102
AVANA	094009	094107	094103
TABACCO	094013	094108	094104
MORO	094017	-	-
Price code	M093	M107	M091

8,8 mm
R11C

	20x120 8"x48"	40x120 16"x48"
	Nat Ret	Nat Ret
LINO	094002	094031
CANAPA	094006	094032
AVANA	094010	094033
TABACCO	094014	094034
MORO	094018	094035
Price code	M093	M131

Pezzi Speciali / Trims. Pièces speciale. Die Sonderstücke

	Battiscopa Skirting	Gradino costa retta** Straight nosed stair**	Gradino costa retta SX - DX** Straight-edge step L-R
	6,5x120	33x120	33x120
	Nat Ret	Nat Ret	Nat Ret
LINO	094090	094060	094080 SX 094070 DX
CANAPA	094091	094061	094081 SX 094071 DX
AVANA	094092	094062	094082 SX 094072 DX
TABACCO	094093	094063	094083 SX 094073 DX
MORO	094094	094064	094084 SX 094074DX
Price code	P040	P207	P231

20 mm
R11C

	40x120		40x120	
	Costa toro Nat Ret	Costa retta Nat Ret	Costa toro Nat Ret	Costa retta Nat Ret
LINO	094327	094320	094355 SX 094341 DX	094348 SX 094334 DX
CANAPA	094328	094321	094356 SX 094342 DX	094349 SX 094335 DX
AVANA	094329	094322	094357 SX 094343 DX	094350 SX 094336 DX
TABACCO	094330	094323	094358 SX 094344 DX	094351 SX 094337 DX
MORO	094331	094324	094359 SX 094345 DX	094352 SX 094338 DX
Price code	P219	P211	P251	P239

20 mm
R11C

	20x60	20x60
LINO	094256	094270 SX 094263 DX
CANAPA	094257	094271 SX 094264 DX
AVANA	094258	094272 SX 094265 DX
TABACCO	094259	094273 SX 094266 DX
MORO	094260	094274 SX 094267 DX
Price code	P205	P205

La gamma completa dei pezzi speciali è disponibile nella "PARTE TECNICA" del catalogo a pag. 493
Our entire range of trims is available in our "TECHNICAL SECTION" of this catalogue pag. 493.
La gamme complète des pièces spéciales est disponible dans la section "PARTIE TECHNIQUE" à la pag. 493 de ce catalogue.
Das komplette Sortiment an Sonderstücken ist in dem "technischen Teil" des Katalogs auf Seite 493 verfügbar.

Imballi / Packings. Emballage. Verpackung

	PCS/BOX	MQ/BOX	KG/BOX	BOX/PAL	MQ/PAL	KG/PAL	PACKING	PACKING SIZE
8,8 mm								
20 x 120	4	0,96	18,01	48	46,08	886	EPAL	80 x 120 x 70h
20 x 120 R11	4	0,96	18,01	48	46,08	886	EPAL	80 x 120 x 70h
CHEVRON 7,5 x 40,7	14DX - 14SX	0,88	15,70	42	36,96	680	EPAL	80 x 120 x 75h
LISTELLO 7,5 x 45	28	0,95	18,20	42	39,9	784	EPAL	80 x 120 x 75h
20 mm								
40 x 120	2	0,96	43,01	24	23,04	1.052	EPAL	80 x 120 x 75h



PEZZI SPECIALI. TRIMS	PCS/BOX	MQ/BOX	KG/BOX	PACKING	PACKING SIZE
8,8 mm					
BATTISCOPA 6,5 x 120	6	-	11,04	EPAL	80 x 120
GRADINO COSTA RETTA 33 x 120 x 3,2h **	2	-	23,00	EPAL	80 x 120
GRADINO COSTA RETTA 33 x 120 x 3,2h SX/DX **	1	-	12,00	EPAL	80 x 120
20 mm					
GRADONE 40 x 120 **	1	-	22,50	EPAL	80 x 120
GRADONE 40 x 120 SX/DX **	1	-	22,50	EPAL	80 x 120
GRIGLIA 20 x 60 **	1	-	6,00	EPAL	80 x 120
GRIGLIA 20 x 60 SX/DX **	1	-	5,50	EPAL	80 x 120

** A disposizione solo su richiesta. Tempi di consegna: 30gg
Available upon request only. Delivery terms: 30 days
Disponible seulement sur requête. Délais de livraison: 30 jours
Verfügbar auf Anfrage. Lieferzeit: 30 Tage



Kauri
LEGNO

Kauri

VICTORIA

TASMAN

NELSON

AWANUI

CATLINS

FIORDLAND

V3
SHADE SPECTRUM
HIGH

ISO 13006 - G - Bla_E ≤ 0,5% - UNI EN 14411 - UGL
ANSI A - 326.3: 2021
WET DYNAMIC COEFFICIENT OF FRICTION

DCOF ≥ 0,42
naturale

100 % DESIGN AND
PRODUCTION OF ITALY

Kauri
LEGNO

8,8 mm R10A naturale



20x120
8"x48"
Nat Ret
Lap Ret



7,5x40,7
3"x16"
Nat



7,5x45
3"x18"
Nat

Decoro / Decor

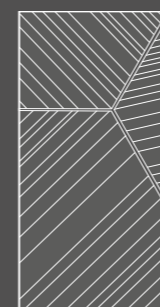

Victoria
Tasman
Awanui
Fiordland

Tech 60x120
24"x48"
Lap Ret

Sviluppo grafico per formato
Pattern by size
Développement graphique par format
Grafischer Entwurf für Format



20x120
8,8 mm

39

7,5x40,7
8,8 mm

50

7,5x45
8,8 mm

50

TASMAN 20x120

39 patterns



Decori

Decors

8,8 mm



Tech Victoria 60x120
24"x48"
Lap Ret



Tech Tasman 60x120
24"x48"
Lap Ret



Tech Awanui 60x120
24"x48"
Lap Ret



Tech Fiordland 60x120
24"x48"
Lap Ret

Kauri

8,8 mm

R 10 A
naturale



20x120
8"x48"

	Nat Ret	Lap Ret	Nat	Nat
VICTORIA	075100	075101	075310	075309
TASMAN	075095	075096	075304	075302
NELSON	075102	075104	075312	075311
AWANUI	075071	075072	075303	075301
CATLINS	075075	075076	075306	075305
FIORDLAND	075085	075086	075308	075307
Price code	M113	M129	M107	M091

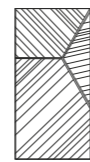

8,8 mm

Tech 60x120
24"x48"

	Lap Ret
VICTORIA	075032
TASMAN	075027
NELSON	-
AWANUI	075003
CATLINS	-
FIORDLAND	075017
Price code	M135

Pezzi Speciali / Trims. Pièces speciale. Die Sonderstücke

8,8 mm

R 10 A
naturale



Battiscopa
Skirting

6,5x120

	Nat Ret	Lap Ret	Nat Ret	Nat Ret
VICTORIA	075162	075163	075210	075212 SX 075214 DX
TASMAN	075160	075161	075204	075206 SX 075208 DX
NELSON	075164	075166	075226	075227 SX 075228 DX
AWANUI	075150	075151	075180	075182 SX 075184 DX
CATLINS	075152	075153	075186	075188 SX 075190 DX
FIORDLAND	075156	075157	075192	075194 SX 075196 DX
Price code	P040	P043	P207	P231

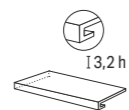

Gradino
costa retta**
Straight nosed stair**

33x120

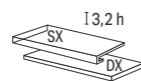

Gradino
costa retta SX - DX**
Straight-edge step L-R

33x120



Floor
Nelson 20x120_8"x48" Lap Ret

Imballi / Packings. Emballage. Verpackung

	PCS/BOX	MQ/BOX	KG/BOX	BOX/PAL	MQ/PAL	KG/PAL	PACKING	PACKING SIZE
8,8 mm								
20 x 120 LAP RET	6	1,44	27,90	24	34,56	670	EPAL	80 x 120 x 55h
20 x 120 NAT RET	4	0,96	18,60	60	57,60	1.136	EPAL	80 x 120 x 55h
DECORI. DECORS								
TECH 60 x 120	2	1,44	27,90	30	43,20	837	EPAL	80 x 120 x 75h
CHEVRON 7,5 x 40,7	14DX - 14SX	0,88	15,70	42	36,96	680	EPAL	80 x 120 x 75h
LISTELLO 7,5 x 45	28	0,95	18,20	42	39,9	784	EPAL	80 x 120 x 75h



PEZZI SPECIALI. TRIMS	PCS/BOX	MQ/BOX	KG/BOX	PACKING	PACKING SIZE
8,8 mm					
BATTISCOPA 6,5 x 120	6	-	11,00	EPAL	80 x 120
GRADINO COSTA RETTA 33 x 120 x 3,2h **	2	-	23,00	EPAL	80 x 120
GRADINO COSTA RETTA 33 x 120 x 3,2h SX/DX **	1	-	12,00	EPAL	80 x 120

** A disposizione solo su richiesta. Tempi di consegna: 30gg
Available upon request only. Delivery terms: 30 days
Disponible seulement sur requête. Délais de livraison: 30 jours
Verfügbar auf Anfrage. Lieferzeit: 30 Tage

Design

Scratch	421
Imagine	429



Sera
FUKSAS tch

Designers: Doriana and Massimiliano Fuksas

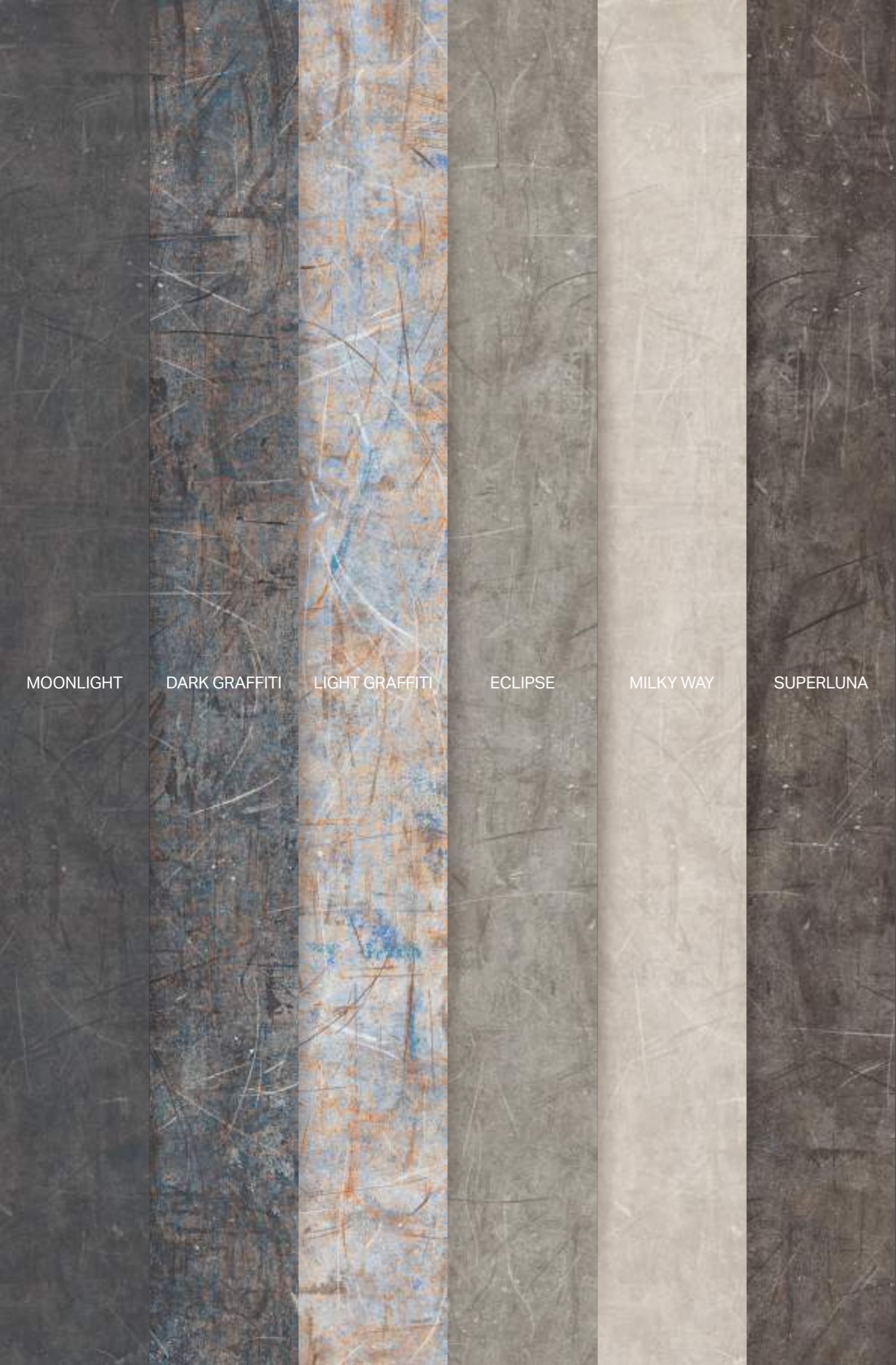

MOONLIGHT

DARK GRAFFITI

LIGHT GRAFFITI

ECLIPSE

MILKY WAY

SUPERLUNA



V2
SHADE SPECTRUM
MODERATE

ISO 13006 - G - Bla_E ≤ 0,5% - UNI EN 14411 - UGL
ANSI A - 326.3: 2021
WET DYNAMIC COEFFICIENT OF FRICTION | DCOF ≥ 0,42



Scratch
FUKSAS DESIGN

6 mm



160x320
63"x126"
Nat Ret

160x160
63"x63"
Nat Ret

80x160
31 1/2"x63"
Nat Ret

80x80
31 1/2"x31 1/2"
Nat Ret

120x280
48"x110"
Nat Ret

modular system

Decoro / Decor



Mosaico 30x30
12"x12"
Nat Ret

8,8 mm



60x120
24"x48"
Nat Ret

Sviluppo grafico per formato
Pattern by size
Développement graphique par format
Grafischer Entwurf für Format



160x320
6 mm
7

160x160
6 mm
14

80x160
6 mm
28

80x80
6 mm
56

120x280
6 mm
11

60x120
8,8 mm
9

Sviluppo Grafico

Pattern by size. Développement graphique par format. Grafischer Entwurf für Format.

LIGHT GRAFFITI 160x320 6 mm

7 patterns

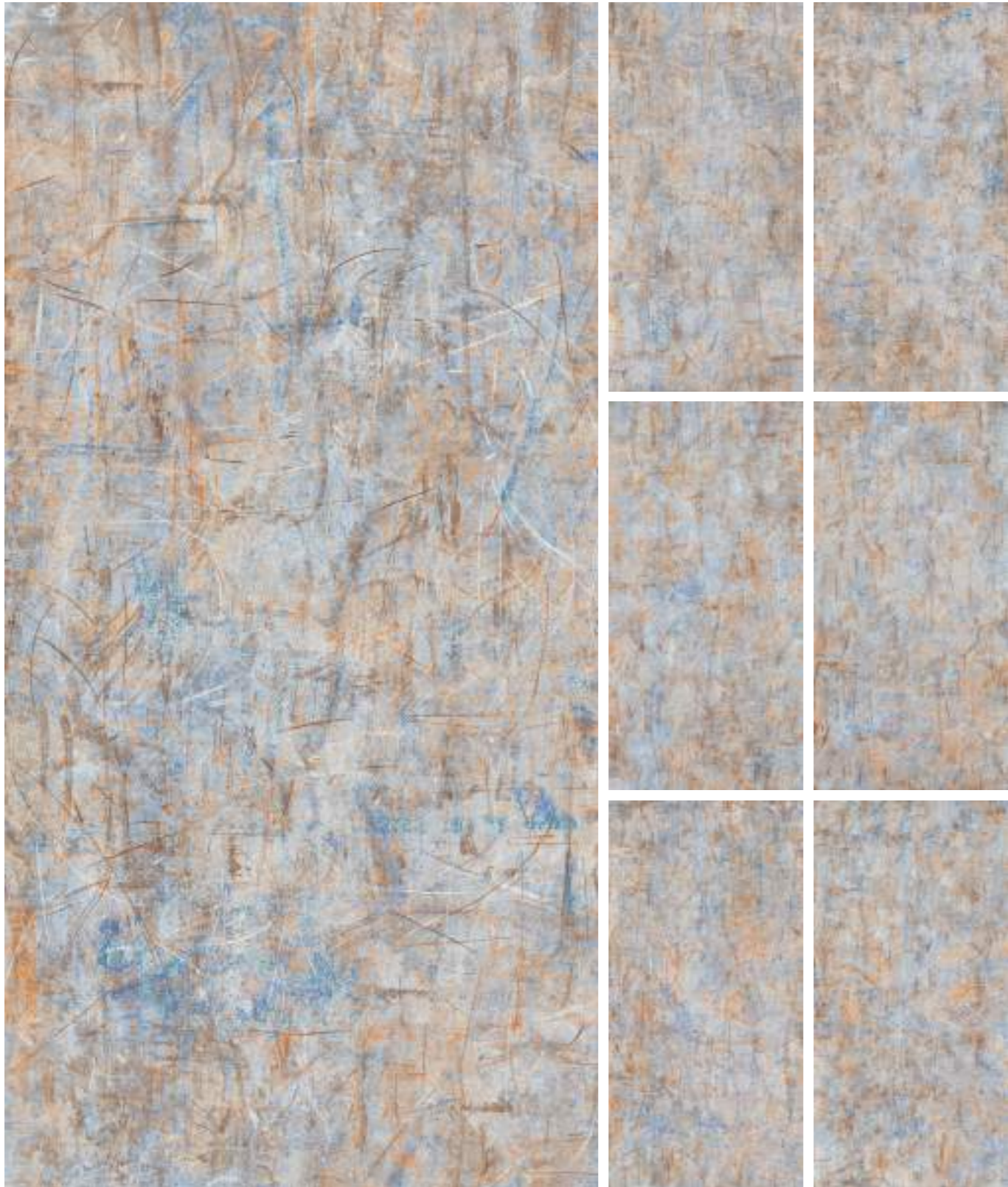

Wall
Light Graffiti 160x320_63'x126" Nat Ret

6 mm

	160x320 63"x126"	160x160 63"x63"	80x160 31 1/2"x63"	80x80 31 1/2"x31 1/2"	120x280 48"x110"	Mosaico 30x30 12"x12"
	Nat Ret	Nat Ret	Nat Ret	Nat Ret	Nat Ret	Nat Ret
MOONLIGHT	149004	149044	149084	149104	149024	149433
DARK GRAFFITI	149006	149046	149086	149106	149026	149435
LIGHT GRAFFITI	149005	149045	149085	149105	149025	149434
ECLIPSE	149002	149042	149082	149102	149022	149431
MILKY WAY	149001	149041	149081	149101	149021	149430
SUPERLUNA	149003	149043	149083	149103	149023	149432
Price code	M181	M169	M155	M133	M163	M193

8,8 mm

	60x120 24"x48"
	Nat Ret
MOONLIGHT	149124
DARK GRAFFITI	149126
LIGHT GRAFFITI	149125
ECLIPSE	149122
MILKY WAY	149121
SUPERLUNA	149123
Price code	M121

Pezzi Speciali / Trims. Pièces speciale. Die Sonderstücke

8,8 mm

	Battiscopa Skirting 6,5x120	Gradino costa retta** Straight-edge stair** 33x120	Gradino costa retta SX - DX** Straight-edge step L-R corner** 33x120
	Nat Ret	Nat Ret	Nat Ret
MOONLIGHT	149204	149313	149333 SX 149323 DX
DARK GRAFFITI	149206	149315	149335 SX 149325 DX
LIGHT GRAFFITI	149205	149314	149334 SX 149324 DX
ECLIPSE	149202	149311	149331 SX 149321 DX
MILKY WAY	149201	149310	149330 SX 149320 DX
SUPERLUNA	149203	149312	149332 SX 149322 DX
Price code	P040	P207	P231

Pezzi Speciali / Trims. Pièces speciale. Die Sonderstücke

6 mm

	Battiscopa Skirting 8x80	Gradino costa retta** Straight-edge stair** 33x160	Gradino costa retta SX - DX** Straight-edge step L-R corner** 33x160
	Nat Ret	Nat Ret	Nat Ret
MOONLIGHT	149213	149253	149273 SX 149263 DX
DARK GRAFFITI	149214	149254	149275 SX 149265 DX
LIGHT GRAFFITI	149215	149255	149274 SX 149264 DX
ECLIPSE	149211	149251	149271 SX 149261 DX
MILKY WAY	149210	149250	149270 SX 149260 DX
SUPERLUNA	149212	149252	149272 SX 149262 DX
Price code	P029	P303	P319

Imballi / Packings. Emballage. Verpackung

	PCS/BOX	MQ/BOX	KG/BOX	PCS/PAL	BOX/PAL	MQ/PAL	KG/PAL	PACKING	PACKING SIZE	TARE (KG)
6 mm										
160 x 320	-	-	-	14	-	71,68	1.178	CASSA	345 x 175 x 37h	140
	-	-	-	44	-	225,28	3.440	CAVALLETTO LEGNO	330 x 75 x 193,5h	177,50
160 x 160	-	-	-	24	-	61,44	970	CASSA	182,6 x 173,6 x 40,4h	80
80 x 160	2	2,56	37,20	-	15	38,40	632	PALLET SPECIALE	168 x 97 x 40,9h	29,4
80 x 80	3	1,92	27,90	-	40	76,80	1.143	EPAL	80 x 120	22
120 x 280	-	-	-	20	-	67,20	1.081	CASSA	292 x 145 x 35h	108
	-	-	-	44	-	147,84	2.285	CAVALLETTO LEGNO	290 x 75 x 161h	145
MOSAICO 30 x 30	9	0,81	11,90	-	60	48,60	716	EPAL	80 x 120	22
8,8 mm										
60 x 120	2	1,44	33,41	-	30	43,20	1027	EPAL	80 x 120	22



Cavalletto in legno
Wood A-Frame. Support en bois.
Holzgestell



Cassa
Crate . Caisse . Kiste



Pallet speciale con sponde
Special pallet with sides.
Palette spéciale avec bords.
Spezial-Palette mit Wandungen.



Epal / Pallet

PEZZI SPECIALI. TRIMS.	PCS/BOX	MQ/BOX	KG/BOX	PACKING	PACKING SIZE
6 mm					
BATTISCOPA 8 x 80	12	0,77	11,50	PALLET	80 x 120
GRADINO COSTA RETTA 33 x 160 x 3,2h **	1	-	9	PALLET SPECIALE	168 x 97 x 40,9h
GRADINO COSTA RETTA 33 x 160 x 3,2h SX/DX **	1	-	10	PALLET SPECIALE	168 x 97 x 40,9h
8,8 mm					
BATTISCOPA 6,5 x 120	6	-	11,40	PALLET	80 x 120
GRADINO COSTA RETTA 33 x 120 x 3,2h **	2	-	22	PALLET	80 x 120
GRADINO COSTA RETTA 33 x 120 x 3,2h SX/DX **	1	-	11	PALLET	80 x 120

**** A disposizione solo su richiesta. Tempi di consegna: 30gg**
Available upon request only. Delivery terms: 30 days
Disponible seulement sur requête. Délais de livraison: 30 jours
Verfügbar auf Anfrage. Lieferzeit: 30 Tage



*Ima.
gine*

ISO 13006 - G - Bla_E ≤ 0,5% - UNI EN 14411 - UGL

100 % DESIGN AND
PRODUCTION OF ITALY

Imagine
DESIGN

Da rivestimento 
Wall tile. Pour revêtement. Für Wandbelag

6 mm



120x280
48"x110"
Nat Ret

8,8 mm



60x120
24"x48"
Nat Ret



KENZIA

BOTANICAL

PLUMAGE

NAIF

PARADISE

JUNGLE
CHIC

SHADOW
LEAVES

AUTUMN

ARECA

Imagine

KENZIA
120x280



6 mm



120x280
48"x110"
174003 Nat Ret

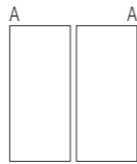

↑
Orientamento
verticale
Vertical
orientation

1 pattern

60x120



8,8 mm



60x120
24"x48"
174023 Nat Ret

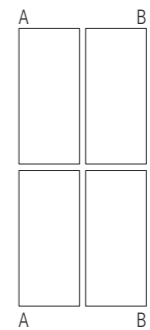

↑
Orientamento
verticale
Vertical
orientation

2 patterns



Wall
Kenzia 120x280_48"x110" Nat Ret

Floor
Statuario Reale 120x280_48"x110" Lap Ret

Imagine

BOTANICAL
120x280



6 mm



120x280
48"x110"
174002 Nat Ret

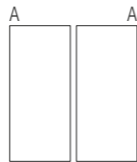

↑
Orientamento
verticale
Vertical
orientation

1 pattern

60x120



8,8 mm



60x120
24"x48"
174022 Nat Ret

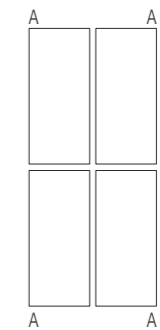

↑
Orientamento
verticale
Vertical
orientation

1 patterns



Wall
Botanical 60x120_24"x48" Nat Ret
Bronze Amani 120x280_48"x110" Lap Ret

Imagine

PLUMAGE
120x280



6 mm



120x280
48"x110"
174004 Nat Ret

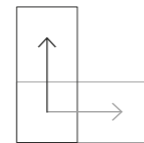
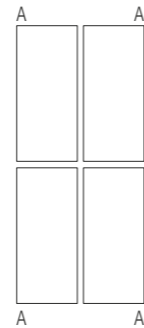

Orientamento
orizzontale e verticale
Vertical and orizontal
orientation

1 pattern

60x120



8,8 mm



60x120
24"x48"
174024 Nat Ret

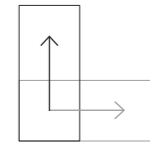
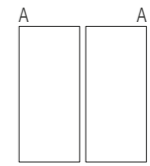

Orientamento
orizzontale e verticale
Vertical and orizontal
orientation

1 pattern



Wall
Plumage 120x280_48"x110" Nat Ret

Imagine

NAIF
120x280



120x280
48"x110"
174009 Nat Ret

120x280
48"x110"
174010 Nat Ret

2 patterns

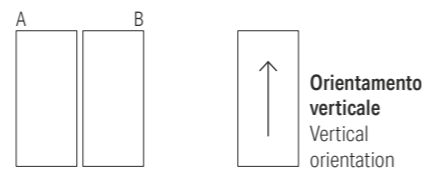

60x120



8,8 mm



60x120
24"x48"
174027 Nat Ret

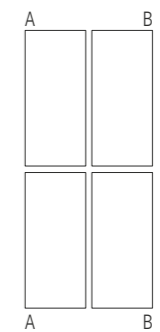

2 patterns



Wall
Naif 120x280_48"x110" Nat Ret

Floor
Il Cerreto Dec. Champagne Grey 30x26_12"x10½" Nat Ret

Imagine

PARADISE
120x280



6 mm

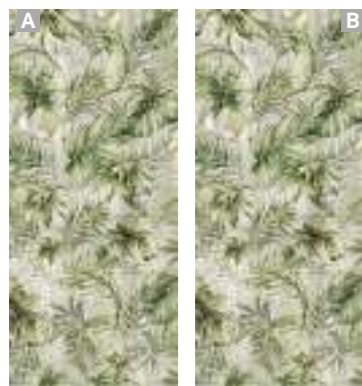

120x280
48"x110"
174007 Nat Ret

120x280
48"x110"
174008 Nat Ret

2 patterns

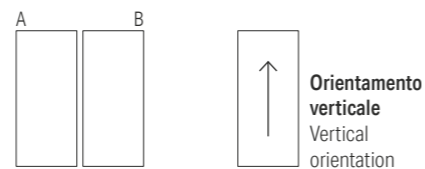

60x120



8,8 mm



60x120
24"x48"
174026 Nat Ret

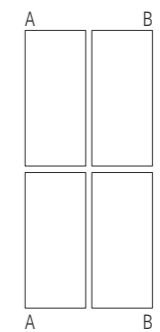

2 patterns



Wall
Paradise 120x280_48"x110" Nat Ret

Imagine

JUNGLE CHIC 120x280



6 mm



2 patterns

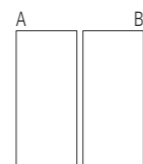

↑
Orientamento
verticale
Vertical
orientation

120x280
48"x110"
174005 Nat Ret

120x280
48"x110"
174006 Nat Ret

60x120



8,8 mm



120x60
48"x24"
174025 Nat Ret

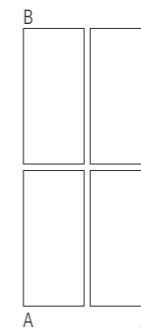

↑
Orientamento
verticale
Vertical
orientation

2 patterns



Wall
Jungle Chic 120x280_48"x110" Nat Ret

Floor
Il Cerreto Pinot Grigio 20x120_8"x48" - 30x120_12"x48" Nat Ret

Imagine

SHADOW LEAVES 120x280



6 mm

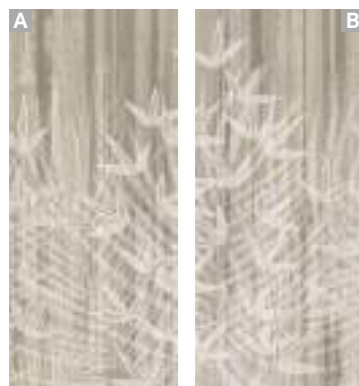

120x280
48"x110"
174011 Nat Ret

120x280
48"x110"
174012 Nat Ret

2 patterns

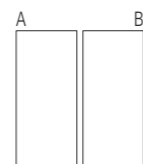

↑
Orientamento
verticale
Vertical
orientation

60x120



8,8 mm



60x120
24"x48"
174028 Nat Ret

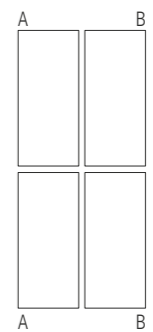

↑
Orientamento
verticale
Vertical
orientation

2 patterns



Wall
Shadow Leaves 120x280_48"x110" Nat Ret

Floor
Imperial Trevi 120x120_48"x48" Nat Ret

Imagine

AUTUMN
120x280



6 mm

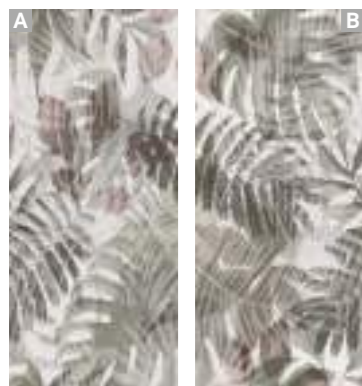

120x280
48"x110"
174013 Nat Ret

120x280
48"x110"
174014 Nat Ret

2 patterns

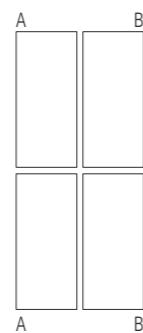

↑
Orientamento
verticale
Vertical
orientation

60x120



8,8 mm



60x120
24"x48"
174029 Nat Ret

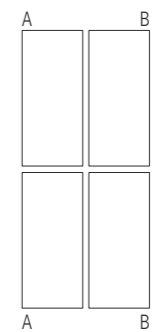

↑
Orientamento
verticale
Vertical
orientation

2 patterns



Wall
Autumn 120x280_48"x110" Nat Ret

Floor
Calacatta Oro 120x280_48"x110" Lap Ret

Imagine

ARECA
120x280



6 mm



120x280
48"x110"
174001 Nat Ret

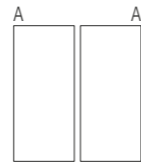

↑
Orientamento
verticale
Vertical
orientation

1 pattern

60x120



8,8 mm



60x120
24"x48"
174021 Nat Ret

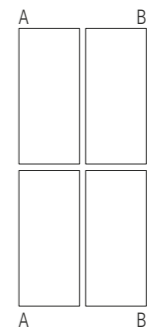

↑
Orientamento
verticale
Vertical
orientation

2 patterns



Wall
Areca 120x280_48"x110" - 60x120_24"x48" Nat Ret



Imagine

DESIGN

Da rivestimento. Wall tile
Pour revêtement. Für Wandbelag

6 mm



120x280
48"x110"

Nat Ret

		Nat Ret	
KENZIA		174003	-
BOTANICAL		174002	-
PLUMAGE		174004	-
NAIF		174009 A 174010 B	-
PARADISE		-	174007 A 174008 B
JUNGLE CHIC		-	174005 A 174006 B
SHADOW LEAVES		174011 A 174012 B	-
AUTUMN		174013 A 174014 B	-
ARECA		-	174001
Price code		M472	M452

8,8 mm



60x120
24"x48"

Nat Ret

		Nat Ret	
KENZIA		174023*	
BOTANICAL		-	174022
PLUMAGE		-	174024
NAIF		174027*	
PARADISE		174026*	
JUNGLE CHIC		174025*	
SHADOW LEAVES		174028*	
AUTUMN		174029*	
ARECA		174021*	
Price code		CP375	P270

*Articolo venduto a composizione

Item sold by composition. Article vendu par composition. Der artikel wird als komposition verkauft.

Imballi / Packings. Emballage. Verpackung

	PCS/BOX	MQ/BOX	KG/BOX	PCS/PAL	BOX/PAL	MQ/PAL	KG/PAL	PACKING	PACKING SIZE	TARE (KG)
6 mm										
120 x 280	-	-	-	20	-	67,20	1.081	CASSA	292 x 145 x 35h	108
	-	-	-	44	-	147,84	2.285	CAVALLETTO LEGNO	290 x 75 x 161h	145
8,8 mm										
60 x 120	2	1,44	31,68	-	20	28,80	656	EPAL	80 x 120	22



Cavalletto in legno
Wood A-Frame.
Support en bois.
Holzgestell



Cassa
Crate . Caisse . Kiste



Epal

Parte tecnica

ADVANCE®

La ceramica che combatte
il coronavirus e i batteri

The tiles fighting
coronavirus and bacteria

457

TANTE FACCE TUTTE DIFFERENTI

Endless looks, all different

464

LA STUOIA

Fiber glass mesh

465

CHEVRON

467

SCHEMI DI POSA

Laying sketch

472

SISTEMI DI POSA 20MM

Installation systems - 20MM

475

LA POSA SOPRAELEVATA

Raised laying

476

LA POSA A SECCO SU ERBA

Dry laying on grass

488

LA POSA A SECCO SU GHIAIA

Dry laying on gravel

489

LA POSA A SECCO SU SABBIA

Dry laying on sand

490

LA POSA A COLLA SU MASSETTO

Adhesive application on screed

491

I PEZZI SPECIALI 20MM

Trims 20MM

493

IMBALLI

Package

498

CARATTERISTICHE TECNICHE

Technical features

500

CERTIFICAZIONI

Certification

503

CORRETTA PULIZIA E MANUTENZIONE DEL PRODOTTO

Important product
cleaning and maintenance

506

CONDIZIONI GENERALI DI VENDITA

General sales terms
and conditions

508

NOTE GENERICHE SUI PRODOTTI

General information
on the products

510



ADVANCE®
 ANTIBACTERIAL & BIO-AIR PURIFYING

La ceramica che combatte il coronavirus e i batteri*

ADVANCE® è una ceramica da pavimento e rivestimento eco-compatibile in gres porcellanato, realizzata in primo ed unico fuoco, ad oltre 1200 gradi di cottura e con il 40% di materie prime riciclate, adatta sia per soluzioni residenziali che non residenziali. L'innovativa tecnologia ADVANCE® grazie alle sue **proprietà antivirali, antibatteriche e fotocatalitiche** è capace di proteggere maggiormente gli ambienti che ci circondano rendendoli più salubri e riducendo significativamente l'inquinamento.

**Dopo 6 ore di esposizione alla luce, ADVANCE® è in grado di eliminare il 100% dei coronavirus e già dopo 15 min. il 90%.*

Dopo 8 ore di esposizione alla luce, combatte le diverse tipologie di batteri da un minimo del 95% fino al 100%.

I risultati dei test di laboratorio effettuati su ADVANCE® sono disponibili sul sito www.advanceceramic.it

The tiles fighting coronavirus and bacteria*

ADVANCE® porcelain floor and wall tiles can be used for residential and non-residential solutions. They are made of eco-friendly and single-fired (over 1,200 degrees) porcelain stoneware and of 40% recycled raw materials. Thanks to its **antiviral, antibacterial and photocatalytic properties**, the innovative ADVANCE® technology is able to improve protection in the environment around us, making it healthier and reducing significantly pollution.

**After 6 hours of light exposure, ADVANCE® is able to eliminate 100% of coronaviruses and just after 15 minutes it will eliminate 90% of them. After 8 hours of light exposure, it fights against different types of bacteria, from a minimum of 95% up to 100%. The results of the laboratory tests carried out on ADVANCE® are available on our website www.advanceceramic.it/en.*

Le carrelage qui combat le coronavirus et le bactéries*

ADVANCE® est une céramique pour sol et mur en grès cérame respectueuse de l'environnement, réalisée en première et unique cuisson cuit à plus de 1200 degrés et composée à 40 % de matières premières recyclées. Elle s'adapte aussi bien aux espaces résidentiels qu'aux autres espaces. Ses **propriétés antivirales, antibactériennes et photocatalytiques** permettent à la technologie innovante ADVANCE® de mieux protéger les espaces qui nous entourent en les assainissant et en réduisant la pollution de manière significative.

**Après 6 heures d'exposition à la lumière, ADVANCE® supprime 100% des coronavirus, et après 15 minutes seulement l'efficacité est déjà de 90%. Après 8 heures d'exposition à la lumière, il élimine différents types de bactéries, avec des résultats à minima de 95% et jusqu'à 100%. Les résultats des test de laboratoire menés sur ADVANCE® sont disponibles sur notre site www.advanceceramic.it/fr*

Die Keramik, die den Coronavirus und Bakterien bekämpft*

ADVANCE® steht für umweltfreundliche Bodenbeläge und Wandverkleidungen aus Feinsteinzeug. Dieses Feinsteinzeug wird im Einbrandverfahren bei einer Brenntemperatur von über 1200 Grad hergestellt. ADVANCE® besteht für 40% aus recycelten Materialien undes ist sowohl für den Wohnbereich als auch für gewerbliche Anwendungen geeignet. Die innovative Technologie von ADVANCE® ist dank ihrer **antiviralen, antibakteriellen und photocatalytischen Eigenschaften** in der Lage, unsere Umgebung gesünder zu machen und die Schadstoffbelastung erheblich zu reduzieren.

**Unter Belichtung kann ADVANCE® bereits nach 15 Minuten 90% der Coronaviren beseitigen und schon nach sechsständiger Belichtung 100%. Nach einer achtstündigen Belichtung bekämpft ADVANCE® die unterschiedlichen Typen von Bakterien um mindestens 95% bis zu 100%. Die mit ADVANCE® geführten Labortests sind auf der Internetseite www.advanceceramic.it/de einsehbar.*

Antiviral
Antibacterial
Antipollution

Futuro, Natura, Scienza

L'IMPEGNO E L'ATTENZIONE VERSO L'AMBIENTE E IL SOCIALE DEL GRUPPO ITALCER HANNO PORTATO ALLA NASCITA DI ADVANCE®, UN NUOVO PROGETTO CHE RAPPRESENTA LA VOLONTÀ DI PROIETTARSI VERSO IL FUTURO TRAMITE UNA CERAMICA INNOVATIVA, REALIZZATA IN PRIMO FUOCO, CON PROPRIETÀ ANTIVIRALI, ANTIBATTERICHE E FOTOCATALITICHE, CAPACI DI SALVAGUARDARE LA SALUTE E RIDURRE L'INQUINAMENTO.

La nostra prima fonte di ispirazione è il FUTURO, poiché abbiamo il sogno di un mondo in cui le nuove generazioni possano utilizzare materiali sempre più sostenibili, che aiutino il benessere del pianeta, riducendo la possibilità di contaminazioni da microrganismi e l'utilizzo di detergenti chimici dannosi per l'ambiente. Utilizziamo principalmente SnO2 (biossido di stagno) e TiO2 (biossido di titanio) biomimetici, ossia ottenuti tramite processi in cui vengono replicati i meccanismi della NATURA. La sintesi avviene in primo fuoco, attraverso un'innovativa tecnica produttiva, frutto di una rivoluzionaria ricerca nel campo della SCIENZA dei materiali.

Future, Nature, Science

ADVANCE® HAS BEEN CREATED THANKS TO ITALCER'S CARE AND ATTENTION FOR THE ENVIRONMENT AND THE COMMUNITY. A NEW PROJECT WHICH REPRESENTS OUR DESIRE TO FOCUS ON THE FUTURE THANKS TO AN INNOVATIVE SINGLE-FIRED PORCELAIN TILE, WITH ANTIVIRAL, ANTIBACTERIAL AND PHOTOCATALYTIC PROPERTIES, ABLE TO SAFEGUARD HEALTH AND REDUCE POLLUTION.

Our first source of inspiration is the FUTURE. We dream of a world in which the new generations can use increasingly sustainable materials that help the well-being of the planet, reducing the possibility of microbial contamination and environmentally harmful chemical detergents.

We mainly use SnO2 (tin oxide) and TiO2 (titanium dioxide) that are biomimetic, i.e. obtained through processes that replicate those found in NATURE. Synthesis takes place during the single firing process via an innovative production technique stemming from a revolutionary research study in the field of materials SCIENCE.

Future, Nature, Science

L'ENGAGEMENT DU GROUPE ITALCER ET L'ATTENTION QU'IL PORTE À L'ENVIRONNEMENT ET AU SECTEUR SOCIAL ONT MENÉ À LA CRÉATION D'ADVANCE®. UN NOUVEAU PROJET QUI REPRÉSENTE L'ENVIE DE SE TOURNER VERS LE FUTUR AU MOYEN D'UNE CÉRAMIQUE INNOVANTE, RÉALISÉE EN PREMIÈRE CUISSON, ET DOTÉE DE PROPRIÉTÉS ANTIVIRALES, ANTIBACTÉRIENNES ET PHOTOCATALYTIQUES CAPABLES DE PRÉSERVER LA SANTÉ ET DE RÉDUIRE LA POLLUTION.

Notre première source d'inspiration est le FUTUR, car nous rêvons d'un monde où les jeunes générations pourront utiliser des matériaux toujours plus durables et respectueux de la planète, réduisant ainsi les risques de contamination par des microorganismes ainsi que l'utilisation de produits chimiques nocifs pour l'environnement. Nous utilisons principalement du SnO2 (dioxyde d'étain) et du TiO2 (dioxyde de titane) biomimétiques, c'est-à-dire obtenus à travers des procédés reproduisant les processus NATURELS.

La synthèse s'effectue lors de la première cuisson grâce à une technique de production innovante, résultat d'une recherche révolutionnaire en SCIENCE des matériaux.

Zukunft, Natur, Wissenschaft

AUS DEM ENGAGEMENT DER ITALCER-GRUPPE UND IHRER RÜCKSICHTNAHME AUF DIE UMWELT UND DEN SOZIALEN BEREICH IST ADVANCE® ENTSTANDEN. DIESES NEUE PROJEKT SPIEGELT AUCH IHREN WILLEN WIDER, DER ZUKUNFT MIT EINER INNOVATIVEN, IM EINBRANDVERFAHREN HERGESTELLTEN KERAMIK ENTGEGENZUGEHEN: IHRE ANTIVIRALEN, ANTIBAKTERIELLEN UND PHOTOKATALYTISCHEN EIGENSCHAFTEN SIND IN DER LAGE, DIE GESUNDHEIT ZU SCHÜTZEN UND DIE UMWELTVERSCHMUTZUNG ZU REDUZIEREN.

Unsere wichtigste Inspirationsquelle ist die ZUKUNFT, denn wir träumen von einer Welt, in der die kommenden Generationen immer nachhaltigere Materialien verwenden können, durch die es unserem Planeten besser geht, indem mögliche Kontaminationen durch Mikroorganismen und damit den Einsatz umweltschädlicher chemischer Reinigungsmittel reduziert werden. Wir verwenden in erster Linie SnO2 (Zinndioxid) und TiO2 (Titandioxid) in biomimetischer Form: sie werden mit Prozessen gewonnen, in denen die Mechanismen der NATUR repliziert werden. Die Synthese erfolgt bereits im ersten Brennvorgang, anhand einer innovativen Produktionstechnik, die das Ergebnis einer revolutionären Forschungsarbeit im Bereich der WISSENSCHAFT der Materialien ist.



Future, nature, science
our inspiration

ITALCER GROUP

Proprietà

La particolare composizione di questo gres permette di **abbattere virus e batteri** quando vengono a **contatto con la superficie ceramica**. ADVANCE® può essere utilizzata come ceramica per pavimentazioni e rivestimenti di pareti ed ha caratteristiche antimicrobiche e fotocatalitiche ottenute in primo fuoco.

Tali caratteristiche, che rendono questo gres di ultima generazione, sono incorporate nella prima fase di creazione della ceramica (cotta in primo fuoco ad oltre 1200°C) diventando così proprietà intrinseche del prodotto stesso, conferendo una protezione contro virus e batteri per tutto il ciclo di vita della piastrella, senza che venga alterato nel tempo o da agenti esterni.

Non essendo uno strato superficiale della ceramica, ma incorporato nella stessa, questa proprietà rimarrà integra nel tempo. Le proprietà antivirali e antibatteriche vengono esaltate da ogni condizione di luminosità, solare e artificiale, ma come dimostrano i Test di laboratori di primaria importanza, tali proprietà restano attive anche in assenza di luce.

** Alle condizioni di cui alla tabella e ai risultati dei test che seguono.*

Properties

The special composition of this stoneware means that viruses and bacteria are destroyed if they come into contact with the tile surface.

ADVANCE® can be used to tile floors and walls and it features antimicrobial and photocatalytic properties achieved after a single firing. These specifications, that qualify this stoneware as the latest generation of porcelain tile, are incorporated during the initial creation phase (a single firing at over 1200°C), thus becoming intrinsic properties of the product, providing protection against viruses and bacteria for the entire lifetime of the tile, without alterations caused by time or external agents. Because it doesn't consist in a top layer on the surface of the porcelain tile, but it is an integral part of it, this property will continue to last through time.

The antiviral and antibacterial properties are enhanced by any solar and artificial light conditions, but as shown by tests made by laboratories of primary importance, these properties remain active even in dark conditions.

** Under the conditions specified in the table and the test results below.*

Future, Nature, Science

La composition particulière de ce grès permet d'éliminer les virus et les bactéries dès que ceux-ci entrent en contact avec la surface en céramique.

ADVANCE® peut être utilisée en tant que céramique murale et de sol et présente des caractéristiques antimicrobiennes et photocatalytiques obtenues en première cuisson.

Ces caractéristiques, qui font de ce grès un matériau de dernière génération, sont intégrées lors de la première phase de création de la céramique (cuite en première cuisson à plus de 1200 degrés), devenant ainsi des propriétés intrinsèques au produit. Elles protègent contre les virus et les bactéries durant tout le cycle de vie du carreau, sans être altérées par le temps ou par des agents extérieurs.

Étant donné que cette propriété est directement intégrée dans la céramique et qu'elle n'est pas uniquement présente en couche superficielle sur cette dernière, elle demeure intacte au fil du temps.

Les propriétés antivirales et antibactériennes sont renforcées en présence de luminosité, qu'elle soit solaire ou artificielle. Néanmoins, comme le prouvent les tests de laboratoires renommés, ces propriétés restent actives même en absence de lumière.

** Sous réserve des conditions énoncées dans le tableau et des résultats des tests suivants.*

Eigenschaften

Die besondere Zusammensetzung dieses Feinsteinzeugs ermöglicht es, Viren und Bakterien abzutöten, die mit der Keramikoberfläche in Kontakt kommen.

ADVANCE® kann sowohl für Bodenbeläge als auch für Wandverkleidungen aus Keramik verwendet werden, und besitzt im Einbrandverfahren erzielte, antimikrobielle und photocatalytische Eigenschaften.

Die Merkmale, die dieses Feinsteinzeug zu einem Produkt der neuesten Generation machen, werden während der ersten Herstellungsphase in die Keramik integriert (Einbrandverfahren bei über 1200°C). So werden sie zu natürlichen Produkteigenschaften, die die Fliesen während ihrer gesamten Lebensdauer gegen Viren und Bakterien schützen, ohne dass sie im Laufe der Zeit oder durch externe Faktoren beeinflusst werden. Da es sich nicht um eine Oberflächenschicht sondern um eine in die Keramik integrierte Eigenschaft handelt, bleibt diese auch langfristig unversehrt bestehen.

Die antiviralen und antibakteriellen Eigenschaften werden durch jede Art von Licht – sowohl Sonnenlicht als auch Kunstlicht – verstärkt, doch wie Tests renommierter Labors bestätigen, bleiben diese Eigenschaften auch ohne Lichteinfall aktiv.

** Bei den in der Tabelle angegebenen Bedingungen und mit den nachfolgenden Testergebnissen.*

Scopri le serie complete. Discover the full series.
Découvrez les séries complètes.
Entdecken Sie die komplette Serie.

Pierres des Châteaux Advance® p. 201
Il Cerreto Advance® p. 387



Wall
Pierres des Châteaux Advance® - Fontainebleau 60x60_24"x24" Nat Ret

Floor
Il Cerreto Advance® - Amarone 23x149 (9"x58 1/2") Nat Ret



Floor
Pierres des Châteaux Advance® - Chenonceau 100x100_40"x40" Nat Ret

Elimina i virus

Eliminates viruses
Élimine les virus
Eliminiert Viren

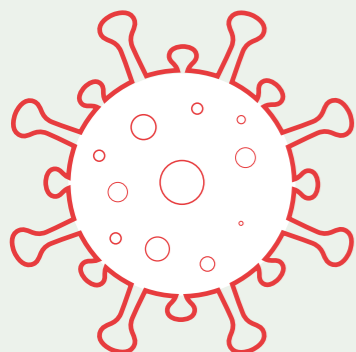

ISO 18061:2014 (E)
Coronavirus 229E
A virus H3N2*

TEST TCNA
(TILE COUNCIL OF NORTH AMERICA)



Tempo di esposizione
Exposure time
Temps d'exposition
Expositionsdauer

15 min	90%
30 min	90%
1 h	90%
4h*	99%
6 h	100%
8 h	100%



Riduzione con esposizione UV
Reduction under UV exposure
Réduction avec exposition aux rayons UV
Reduzierung mit UV-Exposition

90%
90%
90%
99%
100%
100%



Tempo di esposizione
Exposure time
Temps d'exposition
Expositionsdauer

15 min	-
30 min	90%
1 h	90%
4h*	90%
6 h	93%
8 h	99%



Riduzione senza esposizione UV
Reduction under Dark conditions
Réduction sans exposition aux rayons UV
Reduzierung ohne UV-Exposition

-
90%
90%
90%
93%
99%

Elimina i batteri

Fights bacteria
Combat les bactéries
Bekämpft Bakterien

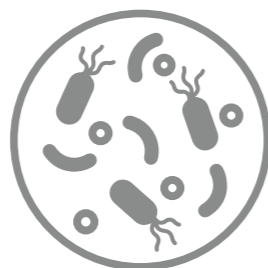

ISO 27447:2019 (E)
Escherichiacoli ATCC 8739
Stafilococco Aureo ATCC 6538

TEST DEL LABORATORIO CFR-UNIFE AND TCNA



Tempo di esposizione
Exposure time
Temps d'exposition
Expositionsdauer

8 h



Riduzione con esposizione UV
Reduction under UV exposure
Réduction avec exposition aux rayons UV
Reduzierung mit UV-Exposition

MIN. 95% - MAX 100%



Tempo di esposizione
Exposure time
Temps d'exposition
Expositionsdauer

8 h



Riduzione senza esposizione UV
Reduction under Dark conditions
Réduction sans exposition aux rayons UV
Reduzierung ohne UV-Exposition

MIN. 93,4% - MAX 97,2%

Riduce l'inquinamento atmosferico / 20,7% di NOx

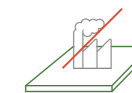

Reduction of atmospheric pollution / Réduction de la pollution atmosphérique / Reduzierte Umweltverschmutzung

UNI 11484 ATTESTED BY THE UNIVERSITY OF TURIN - DEPARTEMENT OF CHEMISTRY

CONVERTE LE SOSTANZE INQUINANTI VOLATILI IN SOSTANZE INNOCUE.

Le proprietà antinquinanti del gres ADVANCE® migliorano anche la qualità dell'aria che respiriamo. La produzione industriale, l'utilizzo di impianti di climatizzazione e dei mezzi di trasporto, emettono nell'aria sostanze inquinanti. ADVANCE® applicata in esterno, nelle pavimentazioni Outdoor, sulle facciate di abitazioni e palazzi, **riesce a diminuire le molecole di NOx** (Ossidi di Azoto) **del 20,7%** (come attestato dall'Università di Torino) in sole tre ore, permettendo di migliorare notevolmente la qualità dell'aria grazie all'azione fotocatalitica che si attiva alla luce naturale. Ogni soluzione outdoor progettata con ADVANCE® **contribuisce a migliorare l'ambiente che ci circonda**. Una tecnologia sicura per la nostra salute e una scelta sostenibile e attenta all'ambiente, in quanto realizzata in un'unica cottura ad altissima temperatura, senza perciò la necessità di ulteriori trattamenti e relativi impatti sull'ambiente.

CONVERTS VOLATILE POLLUTANTS INTO HARMLESS SUBSTANCES.

The anti-pollution properties of ADVANCE® stoneware also improve the quality of the air we breathe. Industrial production, the use of air conditioning systems and vehicles emit pollutants into the atmosphere. ADVANCE® used outdoors on the façades of buildings and apartment blocks, **reduces NOx (nitrogen oxide) molecules by 20.7%** (as attested by the University of Turin) in just three hours, considerably improving air quality thanks to the photocatalytic action activated by natural light. Each outdoor solution designed using ADVANCE® contributes towards **improving the environment around us**. The technology is not only safe for our health, but it is also a sustainable choice that takes care of the environment thanks to the single firing at a very high temperature, and because no further treatments are required and it has no further impact on the environment.

TRANSFORME LES POLLUANTS VOLATILS EN SUBSTANCES INOFFENSIVES.

Les propriétés antipollution du grès ADVANCE® améliorent également la qualité de l'air que nous respirons. La production industrielle, l'usage de systèmes de climatisation et l'utilisation des moyens de transport émettent des polluants atmosphériques. La technologie ADVANCE®, appliquée sur les façades extérieures des habitations et des bâtiments, permet de **réduire la concentration de molécules de NOx (oxydes d'azote) de 20,7%** (comme l'a confirmé l'Université de Turin) en seulement trois heures, ce qui permet d'améliorer de façon considérable la qualité de l'air grâce à l'action photocatalytique qui s'active à la lumière naturelle. Les espaces extérieurs conçus avec ADVANCE® permettent d'**améliorer l'environnement qui nous entoure**. En plus d'être sûre pour notre santé, la technologie représente également un choix durable et respectueux de l'environnement étant donné qu'elle est réalisée lors d'une cuisson unique à très haute température et qu'elle ne nécessite pas de traitements ultérieurs: elle n'engendre donc pas d'impacts supplémentaires sur l'environnement.

FLÜCHTIGE SCHADSTOFFE WERDEN IN UNBEDENKLICHE STOFFE UMGEWANDELT.

Die schadstoffmindernden Eigenschaften des Feinsteinzeugs ADVANCE® verbessern auch die Qualität unserer Atemluft. Die industrielle Produktion, der Einsatz von Klimaanlagen und die Transportmittel tragen zum Ausstoß von Schadstoffen in die Luft bei. Durch die Verwendung von ADVANCE® in Außenbereichen, an den Fassaden von Wohnungen und Gebäuden, **können die NOx-Moleküle (Stickstoffoxid) in nur drei Stunden um 20,7%** reduziert werden (laut Bescheinigung der Universität Turin). Durch die von natürlichem Licht aktivierte photokatalytische Wirkung kann die Qualität der Luft so beachtlich verbessert werden. Alle mit ADVANCE® realisierten Outdoor-Lösungen tragen zu einer **Verbesserung unserer Umwelt bei**. Diese Technologie ist nicht nur sicher für unsere Gesundheit, sondern auch eine nachhaltige und umweltfreundliche Entscheidung, da sie einen einzigen Brennvorgang bei extrem hohen Temperaturen vorsieht, ohne Notwendigkeit nachfolgender Behandlungen und damit ohne weitere Umweltauswirkungen.

Combatta lo sporco / Combats dirt / Combat la saleté / Bekämpft Schmutz



RIDUCE LA NECESSITÀ DI DETERGENTI CHIMICI.

Lo sporco si disgrega sulle superfici ceramiche ADVANCE® e ciò permette di mantenere puliti i pavimenti e i rivestimenti tramite il solo utilizzo di acqua e sapone neutro. Per i pavimenti esterni lo scorrere dell'acqua piovana è sufficiente per garantire la pulizia.

REDUCES THE NEED TO USE CHEMICAL DETERGENTS.

Dirt disintegrates on the surface of ADVANCE® tiles, floors and walls can be kept clean by just washing with a neutral soap and water. For outdoor floors, the flow of rainwater is enough to guarantee cleanliness.

RÉDUIT LE RECOURS AUX DÉTERGENTS CHIMIQUES.

La saleté se décompose sur les surfaces en céramique ADVANCE®, ce qui permet de conserver un sol et des murs propres en les lavant uniquement à l'eau et au savon doux. Pour les sols extérieurs, l'écoulement de l'eau de pluie suffit à garantir une propreté optimale.

REDUZIERT DEN EINSATZ CHEMISCHER REINIGUNGSMITTEL.

Der Schmutz zersetzt sich auf den Keramikoberflächen von ADVANCE®. So können Bodenbeläge und Wandverkleidungen einfach mit Wasser und einem neutralen Reinigungsmittel sauber gehalten werden. Bei Bodenbelägen im Außenbereich garantiert bereits das Abfließen von Regenwasser eine ausreichende Reinigung.

Combatta i cattivi odori / Mitigates bad odours / Réduit les mauvaises odeurs

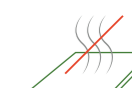

TRASFORMA LE MOLECOLE ORGANICHE RIDUCENDO I CATTIVI ODORI.

Come per gli NOx, le molecole fonti di cattivi odori si decompongono non appena entrano in contatto con la superficie, attenuandone così l'effetto odorifero.

REDUCES BAD ODOURS BY CONVERTING THE ORGANIC MOLECULES.

Furthermore, as for NOx molecules, the molecules that cause bad odours decompose as soon as they come into contact with the surface, thus mitigating any malodorous effect.

TRANSFORME LES COMPOSÉS ORGANIQUES ET RÉDUIT LES MAUVAISES ODEURS.

Comme pour les NOx, les composés à l'origine des mauvaises odeurs se décomposent dès qu'ils entrent en contact avec la surface, réduisant ainsi les mauvaises odeurs.

VERWANDELT ORGANISCHE MOLEKÜLE UND REDUZIERT SO ÜBLE GERÜCHE.

Ebenso wie die NOx-Moleküle zersetzen sich auch die für üble Gerüche verantwortlichen Moleküle, sobald sie mit der Oberfläche in Kontakt kommen und hemmen somit die Geruchsbildung.



Tante facce tutte differenti

La gamma dei colori e dei materiali in gres porcellanato prevedono la presenza di grafiche differenti per garantire un autentico effetto naturale su grandi e piccole estensioni di superficie.

Endless looks, all different

The range of colours and materials in porcelain stoneware slabs feature different graphics to create a realistic, natural feel in large and small areas.

De nombreuses facettes toutes différentes

La gamme des couleurs et des matériaux en grès cérame prévoit la présence de graphismes différents pour garantir un effet naturel authentique sur les petites et grandes surfaces.

Viele verschiedene Seiten

Die Palette der durch die Platten Farben und Materialien sehen das Vorhandensein von unterschiedlichen Grafiken vor, um einen authentischen natürlichen Effekt auf großen und kleinen Oberflächen hervorzurufen.

AESTHETICA WILDE

La stuoia

Per particolari applicazioni, per aumentare la resistenza meccanica al carico ed alla rottura, la lastra può essere fornita con stuoia in fibra di vetro applicata in retro.

Fiber glass mesh

For specific applications and in order to further increase their breaking strength, slabs can be supplied with a fiber glass mesh already fixed on their back.

La fibre de verre

En cas d'utilisations particulières, pour augmenter la résistance mécanique à la charge et à la rupture, la plaque peut être fournie avec une fibre de verre appliquée sur le dos.

Glasfasernetz

Für besondere Anwendungsbereiche kann die Rückseite der Platte auch mit einem Glasfasernetz bestückt werden, um die Bruchlast und den mechanischen Widerstand zu erhöhen.

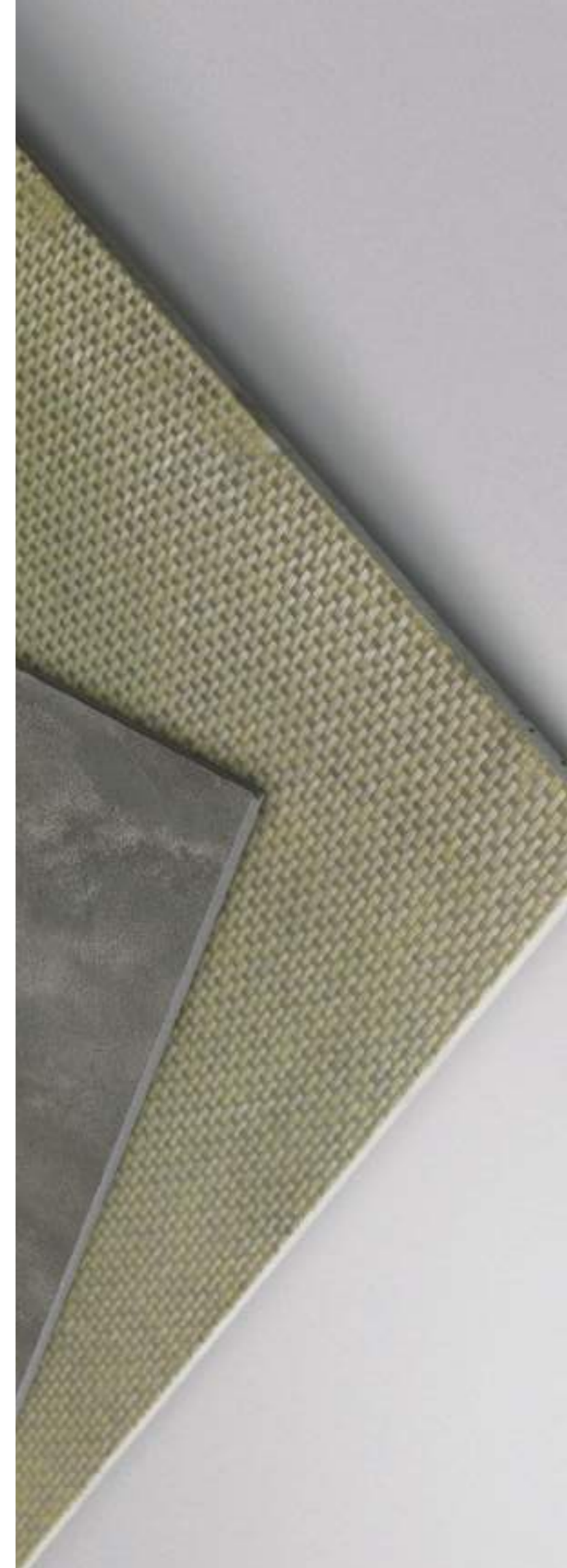



Chevron

Il formato 7,5x40,7 cm combinato al listello 7,5x45 cm permette la creazione di diverse pose, adatte sia a pavimento che a rivestimento, arricchendo gli ambienti di un design artigianale.

The 7.5x40.7 cm tiles combined with the 7.5x45 cm strip allows the creation of different designs, which are suitable for both floors and walls, lending rooms an artisan-like finish.

Le format 7,5x40,7 cm combiné au listel de 7,5x45 cm permet de créer différentes poses, adaptées aussi bien aux carrelages de sol qu'aux revêtements muraux, pour enrichir les espaces avec un design artisanal.

Das Format 7,5x40,7 cm ermöglicht, kombiniert mit der Leiste 7,5x45 cm, die Erstellung verschiedener Verlegungsarten, die sich sowohl für den Boden- als auch für den Wandbelag eignen und die Räume durch ein handwerkliches Design bereichern.

Avvertenze per la posa

Prima della posa controllare tonalità, calibro e scelta. Si consiglia di prelevare piastrelle alternativamente da più scatole. Non si accettano reclami relativi a materiale già posato.

Laying warnings

Before laying, check the colour tones, work size, and quality category. It is advisable to take tiles from multiple boxes alternately. No claims will be entered into for laid tiles.

Avertissements pour la pose

Avant la pose, vérifier la teinte, le calibre et le choix. Il est recommandé de prélever des carreaux en alternance dans plusieurs boîtes. Les réclamations concernant le matériel déjà posé ne sont pas admises.

Hinweise für die Verlegung

Prüfen Sie vor der Verlegung Farbton, Dicke und Qualität. Es wird geraten, die Fliesen abwechselnd aus mehreren Kartons zu entnehmen. Reklamationen bezüglich bereits verlegtem Material werden nicht angenommen.

8,8 mm

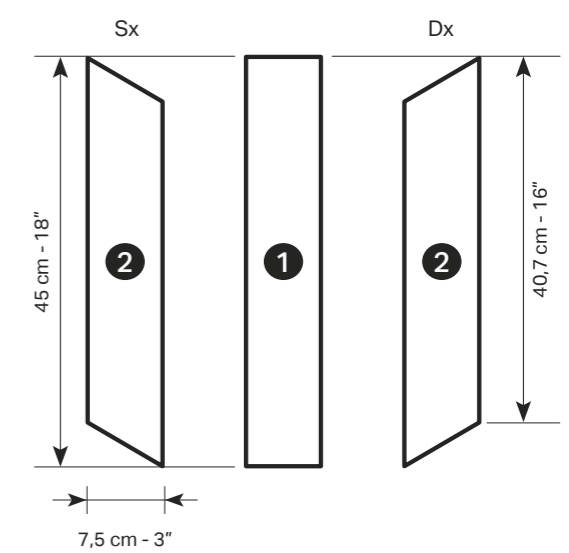

① Listello 7,5x45_3"x18"

② Chevron 7,5x40,7_3"x16"

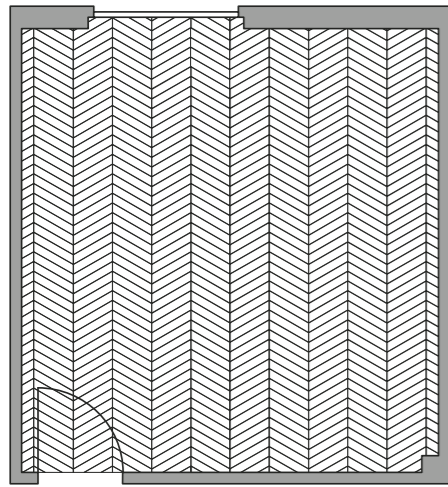

Posa chevron semplice

Basic chevron design
Pose en chevron simple
Einfache chevron-verlegung

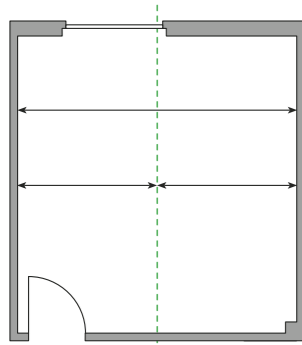
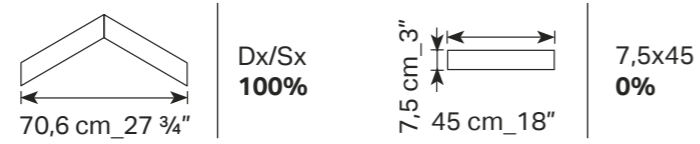

1

Misurare con precisione la larghezza dell'ambiente e tracciare una linea in corrispondenza della mezzeria, come illustrato.

Carefully measure the width of the room and draw the centre line, as shown.

Mesurer la largeur de la pièce avec précision et tracer une ligne au centre d'après l'illustration.

Messen Sie genau die Breite des Raumes und markieren Sie, wie gezeigt, die Mittellinie.

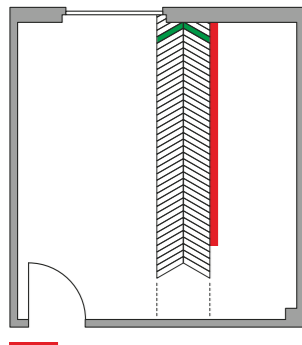

2

Posare il primo Chevron come illustrato. Utilizzare una staggia adeguatamente posizionata come guida. Proseguire la posa fino a terminare la sezione lasciando uno spazio libero per la via d'uscita.

Lay the first chevron as illustrated. Place a levelling bar in position and use as a guide. Keep on laying until you reach the end of the section, leaving room to leave through.

Poser le premier Chevron d'après l'illustration. Utiliser une règle correctement positionnée servant de guide. Poursuivre la pose jusqu'à ce que la section soit terminée en laissant un espace libre pour pouvoir sortir.

Verlegen Sie, wie gezeigt, das erste Chevron. Verwenden Sie ein angemessen positioniertes Zieheisen als Führung. Setzen Sie die Verlegung bis zum Ende des Abschnitts fort und lassen Sie einen Freiraum als Ausgang.

Staggia / Levelling bar / Barre / Zieheisen

Inizio posa Chevron / Start chevron laying / Début de pose Chevron / Beginn der Chevron-Verlegung

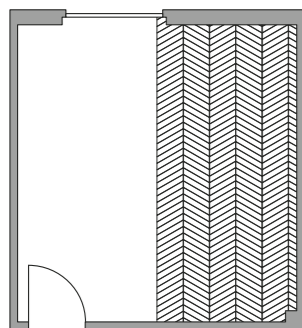

3

Completare la posa della prima metà della stanza, posando una sezione alla volta, sempre con l'aiuto di una staggia adeguatamente posizionata.

Finish laying the first half of the room, laying one section at a time, using a suitably positioned levelling bar.

Terminer l'installation de la première moitié de la pièce, en posant une section à la fois, toujours à l'aide d'une règle correctement positionnée.

Komplettieren Sie die Verlegung in der ersten Hälfte des Zimmers, indem Sie jeweils einen Abschnitt mithilfe eines entsprechend positionierten Zieheisens verlegen.

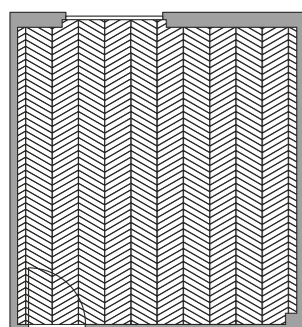

4

Con le stesse modalità, terminare la posa dell'ambiente.

Proceeding in this fashion, finish laying the room.

Terminer la pose du carrelage dans la pièce en suivant les mêmes modalités.

Stellen Sie mit der gleichen Vorgehensweise die Verlegung im Raum fertig.

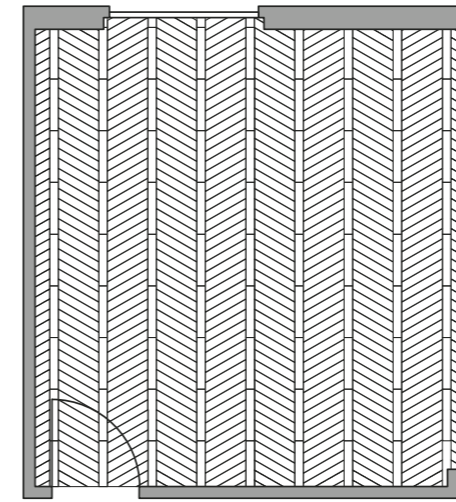

Posa chevron con tappeto

Chevron design with rug effect
Pose en chevron avec tapis
Chevron-verlegung mit teppich

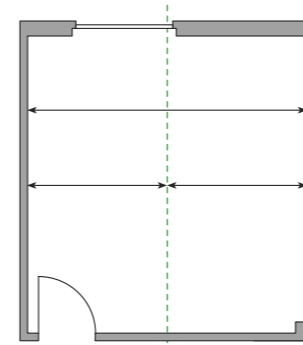
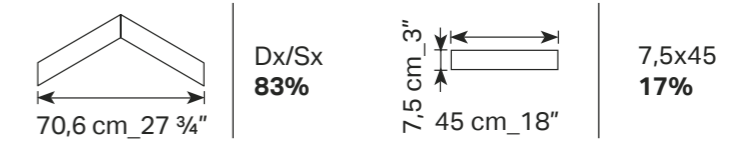

1

Misurare con precisione la larghezza dell'ambiente e tracciare una linea in corrispondenza della mezzeria, posare la prima fila di 7,5x45 come illustrato.

Carefully measure the width of the room and draw the centre line, as shown, then lay the first column.

Mesurer la largeur de la pièce avec précision et tracer une ligne au centre, poser la première rangée de 7,5x45, d'après l'illustration.

Messen Sie genau die Breite des Raumes und markieren Sie die Mittellinie. Verlegen Sie, wie gezeigt, die erste Reihe von 7,5x45.

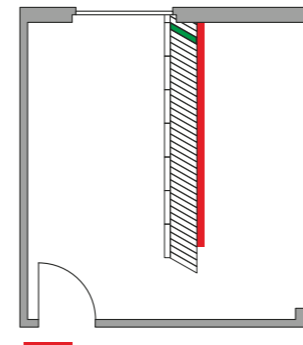

2

Utilizzare una staggia adeguatamente posizionata come guida e posare la prima fila di Chevron come illustrato, lasciando uno spazio libero per la via d'uscita.

Use a levelling bar positioned as a guide, lay the first column of chevrons, as shown, leaving room to leave through.

Utiliser une règle correctement positionnée servant de guide et poser la première rangée de Chevrons d'après l'illustration, en laissant un espace libre pour pouvoir sortir.

Verwenden Sie ein angemessen positioniertes Zieheisen als Führung und verlegen Sie, wie gezeigt, die erste Reihe Chevron, wobei Sie einen Freiraum als Ausgang lassen.

Staggia / Levelling bar / Barre / Zieheisen

Inizio posa Chevron / Start chevron laying / Début de pose Chevron / Beginn der Chevron-Verlegung

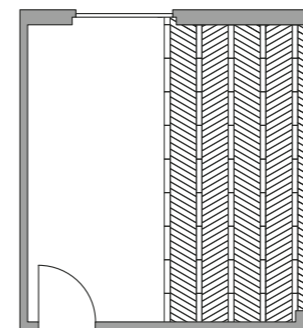

3

Completare la posa della prima metà della stanza, posando una sezione alla volta, sempre con l'aiuto di una staggia adeguatamente posizionata.

Finish laying the first half of the room, laying one section at a time, using a suitably positioned levelling bar.

Terminer l'installation de la première moitié de la pièce, en posant une section à la fois, toujours à l'aide d'une règle correctement positionnée.

Komplettieren Sie die Verlegung in der ersten Hälfte des Zimmers, indem Sie jeweils einen Abschnitt mithilfe eines entsprechend positionierten Zieheisens verlegen.

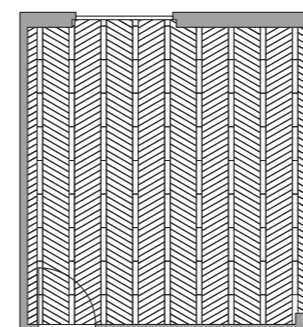

4

Con le stesse modalità, terminare la posa dell'ambiente.

Proceeding in this fashion, finish laying the room.

Terminer la pose du carrelage dans la pièce en suivant les mêmes modalités.

Stellen Sie mit der gleichen Vorgehensweise die Verlegung im Raum fertig.

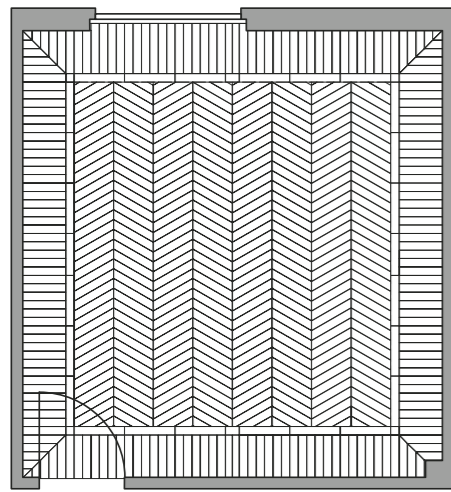

Posa chevron con tappeto

Chevron design with rug effect
Pose en chevron avec tapis
Chevron-verlegung mit teppich

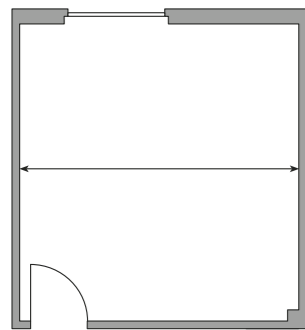
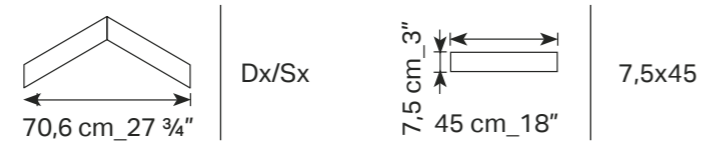

1

Misurare con precisione la larghezza dell'ambiente come illustrato.

Carefully measure the width of the room, as shown.

Mesurer la largeur de la pièce avec précision d'après l'illustration.

Messen Sie, wie gezeigt, genau die Breite des Raumes.

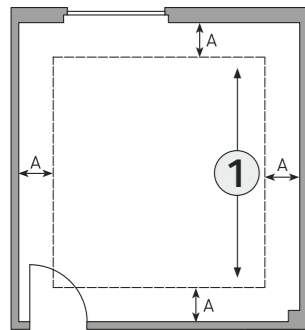

2

Tracciare l'area che dovrà contenere il tappeto centrale, assicurandosi di mantenere per ogni lato la medesima distanza dalle pareti, nel seguente modo:

- Sottrarre sempre la misura costante di 105 cm dalla misura della larghezza dell'ambiente (da esempio 375-105=270).
- Dividere la misura così ottenuta per la lunghezza dello Chevron che è 70,6 cm ($270/70,6=3,8$).
- Arrotondare il risultato all'intero superiore, quindi 3,8 diventa 4.
- Moltiplicare la lunghezza dello Chevron per il numero appena ricavato ($70,6*4=282,4$).
- Per determinare la distanza A (come da esempio) del tappeto centrale rispetto alle pareti, occorre sottrarre il risultato ottenuto dalla larghezza dell'ambiente e dividerlo per 2. Quindi la distanza A sarà: $(375-282,4)/2=46,3$ cm.

Mark out the central rug effect area, making sure to keep the same distance from the walls for each side, as follows:

- *Always subtract 105 cm from the width of the room (for example room measuring 375 cm: $375-105=270$).*
- *Then divide the result obtained by the length of the chevron (which is 70.6 cm), e.g. $270 \div 70.6 = 3.8$.*
- *Round the result up to the nearest whole number, which means 3.8 becomes 4.*
- *Multiply the length of the chevron by the number just obtained ($70.6 \times 4 = 282.4$).*
- *To calculate the distance A (as shown in the example) between the central rug section and the walls, subtract the result obtained from the width of the room and then divide it by 2. Distance A will therefore be: $(375-282.4)/2=46.3$ cm.*

Tracer la zone qui contiendra le tapis central, en veillant à garder la même distance des murs, comme suit:

- *Toujours soustraire la mesure constante de 105 cm de la mesure de la largeur de la pièce (par exemple 375-105=270).*
- *Diviser la mesure ainsi obtenue par la longueur du Chevron qui est de 70,6 cm ($270/70,6=3,8$).*
- *Arrondir le résultat à l'entier supérieur : 3,8 devient ainsi 4.*
- *Multiplier la longueur du Chevron par le nombre qu'on vient d'obtenir ($70,6*4=282,4$).*
- *Pour déterminer la distance A (comme dans l'exemple) du tapis central par rapport aux murs, il faut soustraire le résultat obtenu de la largeur de la pièce et le diviser par 2. La distance A sera donc : $(375-282,4)/2=46,3$ cm.*

Markieren Sie den Bereich, in dem sich der mittlere Teppich befinden soll, und vergewissern Sie sich auf folgende Weise, dass auf jeder Seite den gleichen Abstand zu den Wänden eingehalten wird:

- *Ziehen Sie stets das konstante Maß von 105 cm von der gemessenen Raumbreite ab (zum Beispiel 375-105=270).*
- *Teilen Sie das so erhaltene Maß durch die Länge des Chevron, die 70,6 cm beträgt ($270/70,6=3,8$).*
- *Runden Sie das Ergebnis nach oben auf eine ganze Zahl, d.h. 3,8 wird 4.*
- *Multiplizieren Sie die Länge des Chevron mit der gerade ermittelten Zahl ($70,6*4=282,4$).*
- *Zur Bestimmung des Abstandes A (gemäß Beispiel) des mittleren Teppichs von den Wänden muss das erzielte Ergebnis von der Raumbreite abgezogen und durch 2 geteilt werden. Somit beträgt der Abstand A: $(375-282,4)/2=46,3$ cm.*

1
Senso di posa.
Laying direction.
Sens de pose.
Verlegerichtung.

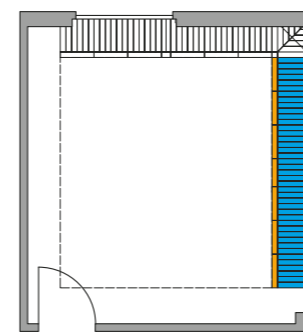

3

Iniziare la posa di fascia e bindello fino a completare due lati dell'ambiente come illustrato, avendo l'accortezza di posare l'eventuale pezzo tagliato contro la parete, in modo da poter poi coprire il taglio con il battiscopa.

Begin laying the outer border band and the inner border line, to complete two sides of the room as illustrated, taking care to lay the cut piece against the wall so that the cut can then be covered with the skirting board.

Commencer la pose des lames de bordure et de raccord et compléter les deux côtés d'après l'illustration, en prenant soin de poser chaque pièce coupée contre le mur, de manière à pouvoir couvrir le côté coupé avec la plinthe.

Beginnen Sie, wie gezeigt, mit der Verlegung des äußeren Streifens und des inneren Randes bis zur Fertigstellung von zwei Seiten des Raumes. Achten Sie dabei darauf, dass eventuell geschnittene Stück zur Wand zu richten, so dass der Schnitt später mit der Sockelleiste verdeckt werden kann.

Bindello / Inner border line / Lame de raccord / Innerer Rand

Fascia / Outer border band / Lame de bordure / Äußerer Streifen

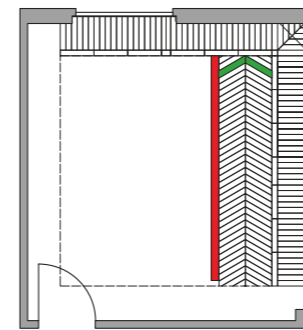

4

Posare il primo Chevron del tappeto centrale come evidenziato in figura. Utilizzare il bindello posato in precedenza e una staggia adeguatamente posizionata come guida. Proseguire la posa fino a terminare l'intera sezione.

Lay the first chevron of the central 'rug' section as shown in the figure. Use the inner border line laid earlier and a suitably positioned levelling bar as a guide. Keep laying until the entire section is finished.

Poser le premier Chevron du tapis central d'après la figure. Utiliser la lame de raccord posée précédemment et une règle correctement positionnée servant de guide. Continuer la pose pour terminer l'ensemble de la section.

Verlegen Sie das erste Chevron des mittleren Teppichs, wie in der Abbildung gezeigt. Verwenden Sie der zuvor verlegte innere Rand und ein angemessen positioniertes Zieheisen als Führung. Setzen Sie die Verlegung bis zur Fertigstellung des gesamten Bereichs fort.

Staggia / Levelling bar / Barre / Zieheisen

Inizio posa Chevron / Start chevron laying / Début de pose Chevron / Beginn der Chevron-Verlegung

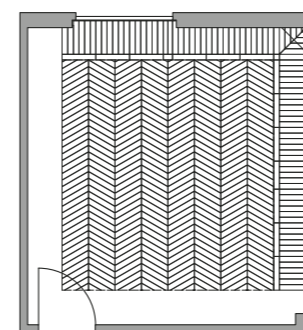

5

Terminare in questo modo l'intera posa del tappeto centrale.

Proceeding in this fashion, finish laying the entire central 'rug' section.

Terminer la pose du tapis central suivant cette modalité.

Beenden Sie auf diese Weise die gesamte Verlegung des mittleren Teppichs.

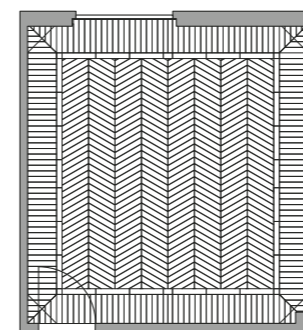

6

Concludere la stanza con la posa di fascia e bindello mancanti.

Finish the room by laying the missing part of the outer border band and the inner border line.

Conclure la pièce en posant les lames de bordure et de raccord manquantes.

Stellen Sie den Raum durch Verlegung der äußeren Streifen und inneren Ränder fertig, die verbleiben.

Schemi di posa

Laying sketch

Schémas de pose

Modulverlegungsbeispiele

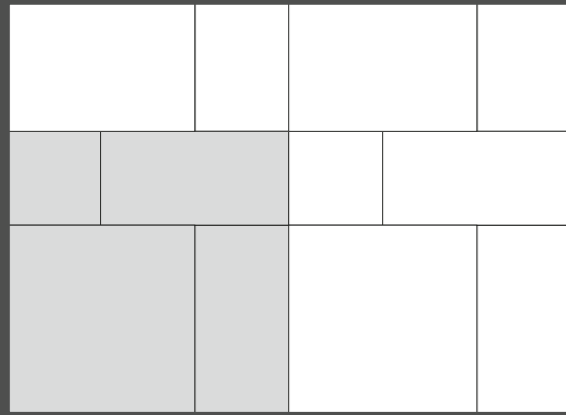

120x120=57,1%
60x120=28,6%
60x60=14,3%

A

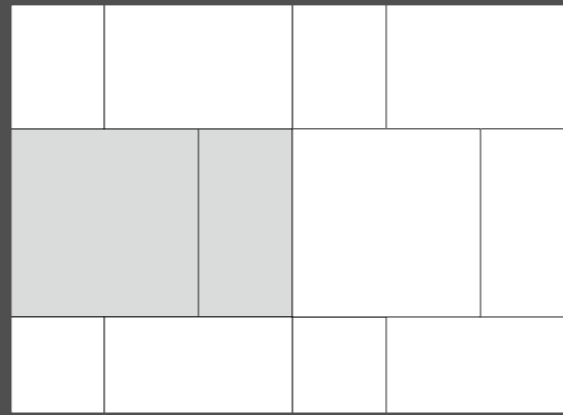

120x120=66,7%
60x120=33,3%
100x100=66,7%
50x100=33,3%

B

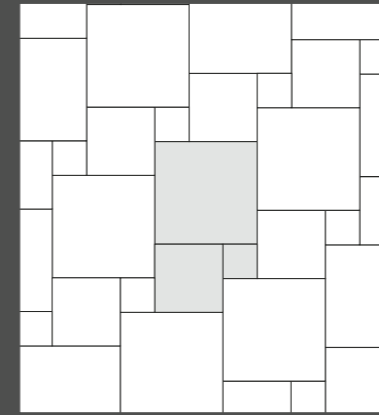

60,9x60,9=64,4%
40,6x40,6=28,6%
20,3x20,3=7%

I

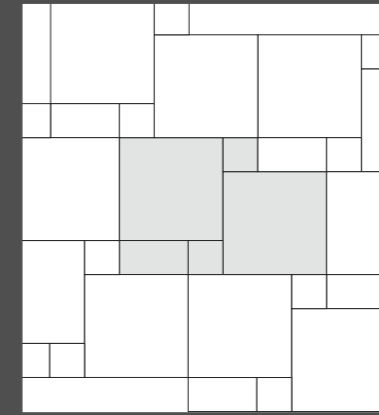

60,9x60,9=82%
20,3x40,6=9%
20,3x20,3=9%

J

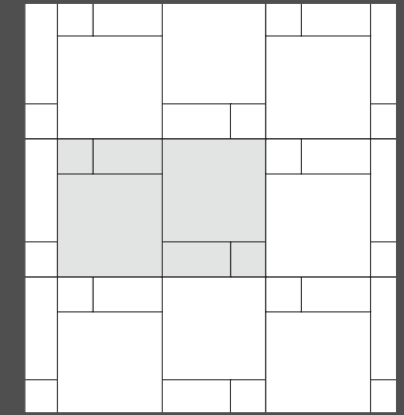

60,9x60,9=75%
20,3x40,6=16,7%
20,3x20,3=8,3%

K

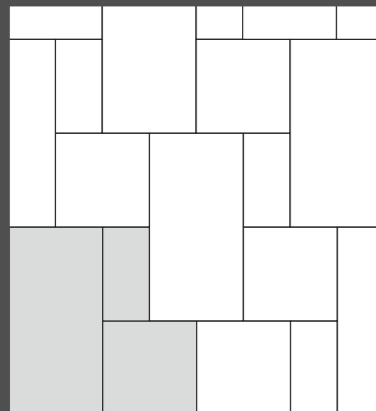

60x120=57,1%
60x60=28,6%
30x60=14,3%

C

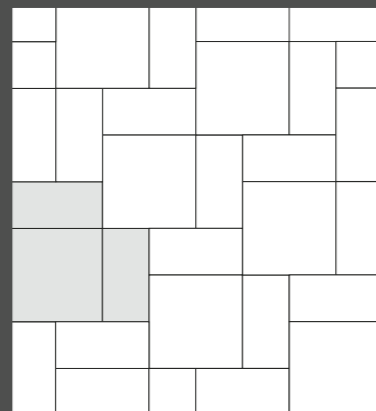

60x60=50%
30x60=50%

D

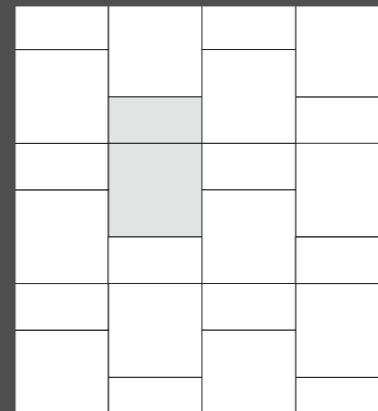

60x60=66,7%
30x60=33,3%

E

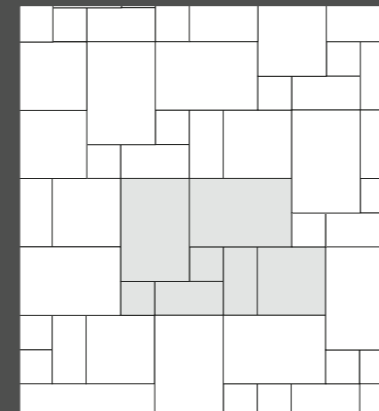

40,6x60,9=55%
40,6x40,6=18%
20,3x40,6=18%
20,3x20,3=9%

L

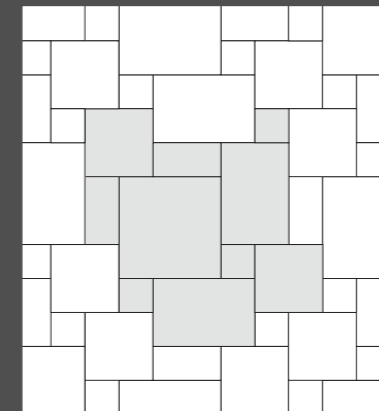

60,9x60,9=25%
40,6x60,9=33,3%
40,6x40,6=22,2%
20,3x40,6=11,1%
20,3x20,3=8,3%

M

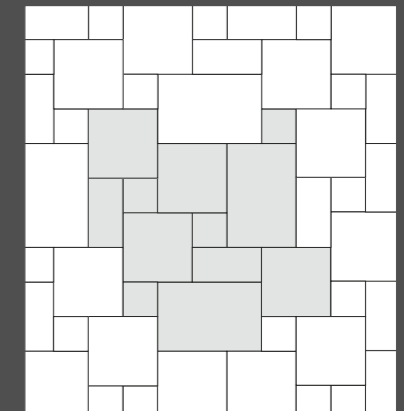

40,6x60,9=33,3%
40,6x40,6=44,5%
20,3x40,6=11,1%
20,3x20,3=11,1%

N

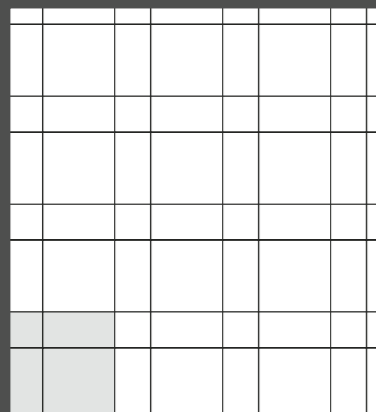

40,6x40,6=44,4%
20,3x40,6=44,4%
20,3x20,3=11,1%

F

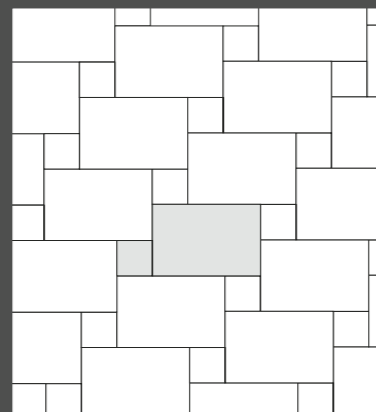

40,6x60,9=85,7%
20,3x20,3=14,3%

G

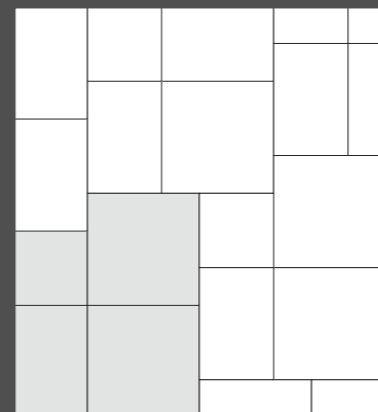

60,9x60,9 = 64,3%
40,6x60,9 = 21,4%
40,6x40,6 = 14,3%

H

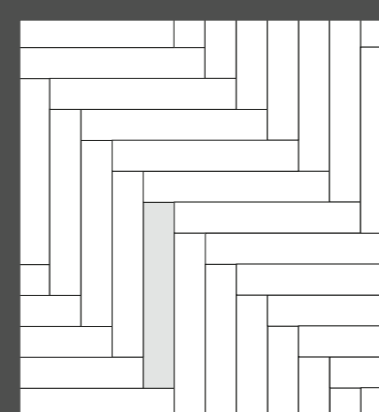

23x149=100%

O

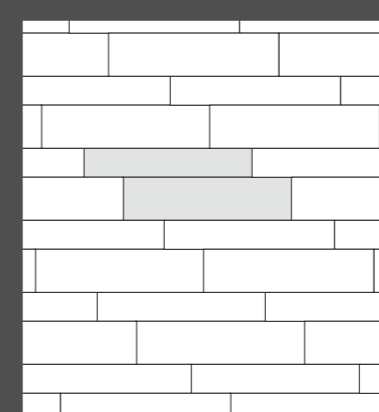

20x120=40%
30x120=60%

P

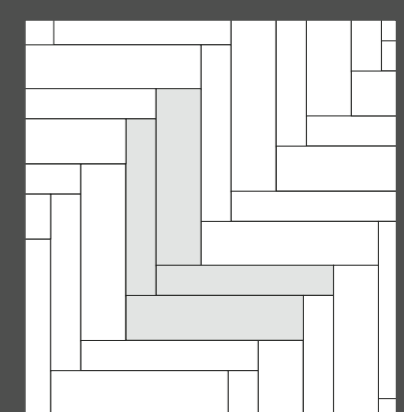

20x120=40%
30x120=60%

Q

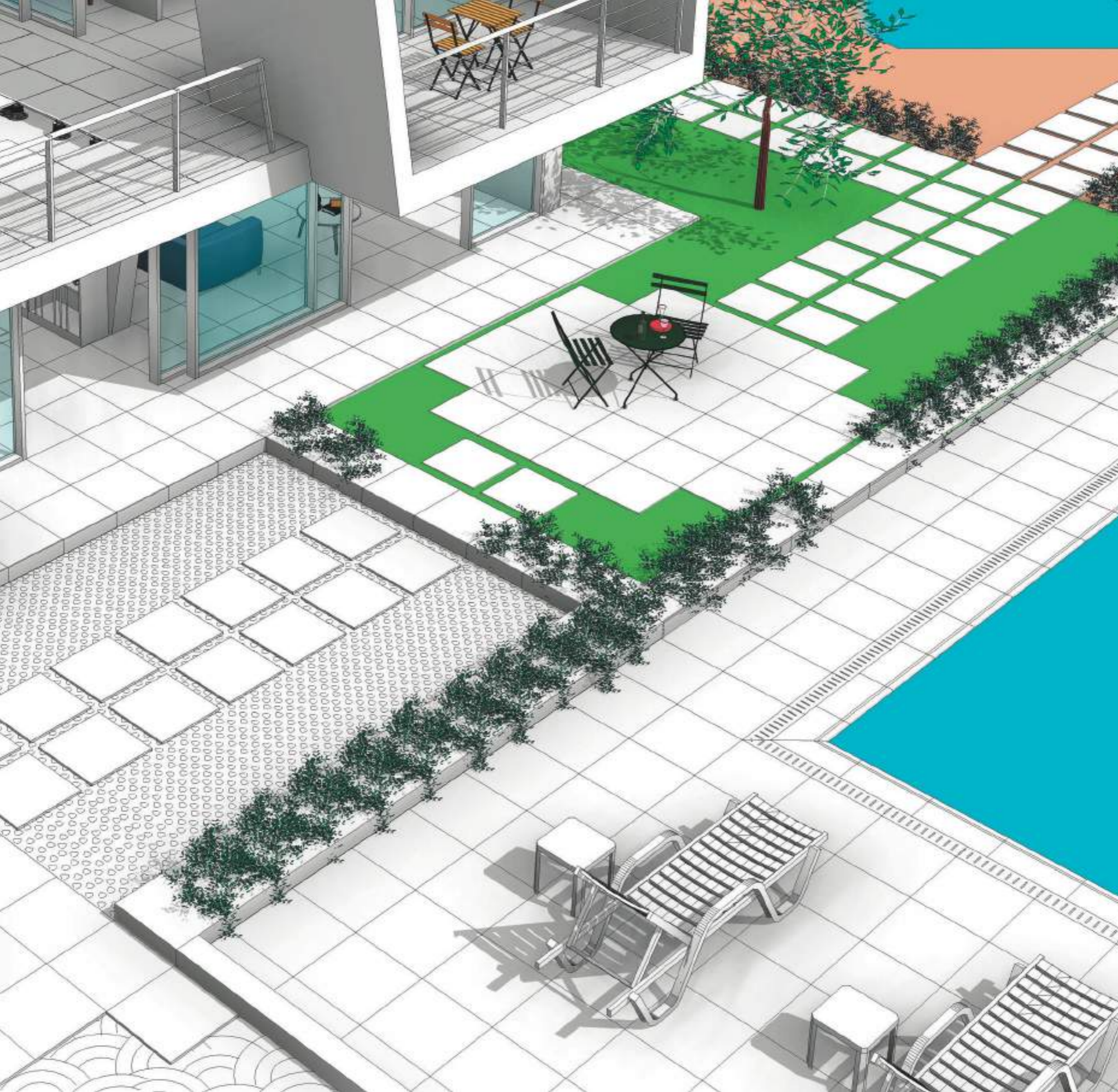

20MM R11C

Sistemi di posa

Installation systems
Systèmes de pose
Verlegungsarten

Pavimento sopraelevato

*Raised installation
Pose surélevée
Verlagen von Doppelboden*

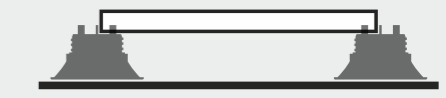

Posa a secco su erba

*Dry installation on grass
Pose à sec sur l'herbe
Trockenverlegung auf gras*

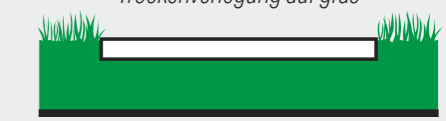

Posa a secco su ghiaia

*Dry installation on gravel
Pose à sec sur gravier et sable
Trockenverlegung auf Kies*

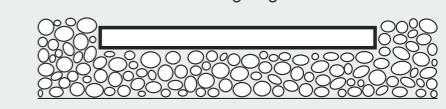

Posa a secco su sabbia

*Dry placement on sand
Pose à sec sur la sable
Trockenverlegung auf Sand*

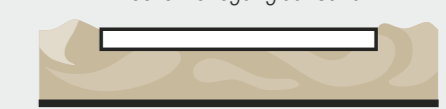

Posa a colla tradizionale

*Traditional laying with glue
Pose à colle traditionnelle
Verlagung mit Kleber*



La posa sopraelevata

Raised laying
La pose surélevée
Verlegung als Doppelboden

I pavimenti sopraelevati sono la soluzione ideale per gli interventi di recupero edilizio e per i nuovi edifici. I loro vantaggi sono molteplici: sono **semplici e veloci da posare** e altrettanto **rapidi da rimuovere** per l'eventuale manutenzione di cavi e tubature o per ispezionare lo strato impermeabilizzante. Inoltre, **assorbono le dilatazioni** ed i movimenti strutturali, evitando crepe e rotture, e **favoriscono il ricircolo dell'aria** nello spazio tra la pavimentazione e l'impermeabilizzazione.

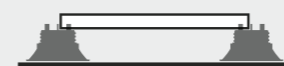

Raised floors are the ideal solution for building renovations and new buildings. Their advantages are many: they are simple and quick to install and just as quick to remove for any maintenance of cables and pipes or to inspect the waterproofing layer. Moreover, they absorb expansions and structural movements, thus preventing cracks and breaks, and facilitate air recirculation between the floor and the waterproofing layer.

Les planchers surélevés sont la solution idéale pour les interventions de récupération des bâtiments et pour les nouveaux bâtiments. Leurs avantages sont nombreux: ils sont simples et rapides à poser et tout aussi rapides à enlever pour l'entretien éventuel des câbles et tuyaux ou pour inspecter la couche d'étanchéité. De plus, ils absorbent la dilatation et les mouvements structurels, évitant les fissures et les cassures, et favorisent la recirculation de l'air dans l'espace entre le revêtement de sol et l'imperméabilisation.

Aufgestellte Bodenbeläge sind die ideale Lösung für Sanierungsarbeiten und Neubauten. Ihre Vorteile sind vielfältig: Sie lassen sich schnell und einfach verlegen und können ebenso schnell wieder entfernt werden, wenn Arbeiten an Kabeln und Rohren durchzuführen sind oder die Abdichtungsschicht geprüft werden muss. Außerdem werden Ausdehnungen und Bewegungen ausgeglichen, wodurch Risse und Brüche vermieden werden, und die Luftzirkulation zwischen Belag und Abdichtungsebene wird erleichtert.



Il sistema per la posa di pavimentazioni sopraelevate, MAXI in tutto

The system for the installation of raised floors, maxi in everything
Le système de pose de planchers surélevés, maxi dans tous
Das System zur Stelzlagerverlegung, maximal in allen Belangen

PP level DUO MAXI è una **gamma di supporti regolabili per pavimenti sopraelevati da esterno** progettata e prodotta da Profilpas. MAXI flessibilità: grazie al comodo anello Fixed Head Ring, si può trasformare la testa autolivellante, capace di compensare pendenze di superficie fino al 5%, in testa fissa, direttamente in fase di posa. MAXI tenuta: il supporto garantisce un'eccellente resistenza ai grandi carichi ed agli agenti atmosferici. MAXI versatilità: numerosi accessori a disposizione per qualsiasi esigenza di posa, dalle prolunghe ai travetti in alluminio, passando per i tappetini in gomma e le clip in acciaio. Con PP level DUO MAXI la posa del pavimento sopraelevato risulterà agevole, veloce e a regola d'arte.

PP level DUO MAXI is a range of adjustable supports for outdoor raised floors designed and produced by Profilpas. MAXI flexibility: thanks to the practical Fixed Head Ring, you can transform the self-levelling head, able to compensate for surface slopes up to 5%, into fixed head, directly during the installation. MAXI strength: the support guarantees excellent resistance to heavy loads and weather elements. MAXI versatility: numerous accessories are available for any installation requirement, from extensions to aluminium joists, rubber mats and steel clips. With PP level DUO MAXI the installation of the raised floor will be easy, fast and perfect.

PP level DUO MAXI est une gamme de supports réglables pour sols extérieurs surélevés conçus et fabriqués par Profilpas. Flexibilité MAXI: grâce à la bague de tête fixe pratique, la tête basculante, capable de compenser les pentes de surface jusqu'à 5%, peut être transformée en tête fixe, directement lors de l'installation. Force MAXI: le support garantit une excellente résistance aux charges importantes et aux agents atmosphériques. Polyvalence MAXI: nombreux accessoires disponibles pour tout besoin d'installation, des rallonges aux solives d'aluminium, en passant par les tapis de caoutchouc et les clips d'acier. Avec PP level DUO MAXI, l'installation du plancher surélevé sera facile, rapide et professionnelle.

Für aufgestellte Bodenbeläge im Außenbereich bietet das PP level DUO MAXI System eine große Auswahl an, die von Profilpas entwickelt und hergestellt werden. MAXIMALE Flexibilität: Dank des Arretierelements Perfect Ring kann der selbstnivellierende Kopf, der eine Oberflächenneigung von bis zu 5% ausgleichen kann, direkt beim Verlegen zu einem Festkopf umfunktioniert werden. MAXIMALE Haltbarkeit: Die Stelzlagerstützen verfügen über eine hohe Druckfestigkeit und bieten eine ausgezeichnete Widerstandsfähigkeit gegen Witterungseinflüsse. MAXIMALE Vielseitigkeit: Umfangreiches Zubehör für alle Verlegeanforderungen, von Verlängerungselementen über Aluminiumträger bis hin zu Gummipads und Stahlklammern. PP level DUO MAXI ermöglicht eine einfache, schnelle und präzise Verlegung von selbsttragenden Bodenbelägen aus Keramik, Naturwerkstein, Holz oder anderen Materialien.

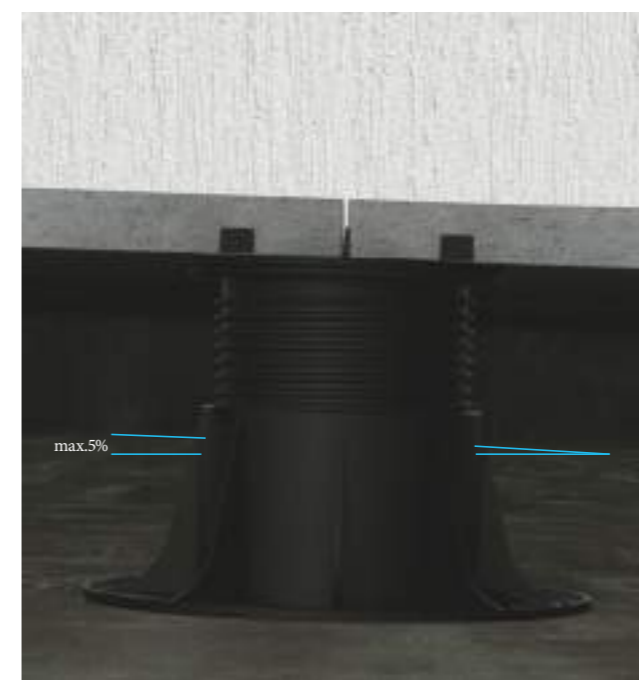

SUPPORTO CON TESTA FISSA

FIXED HEAD SUPPORT
SUPPORT AVEC TÊTE FIXE
TRAGER MIT FESTEM KOPF



SUPPORTO CON TESTA AUTOLIVELLANTE

SELF-LEVELLING HEAD SUPPORT
SUPPORT AVEC TÊTE BASCULANTE
TRAGER MIT SELBSTNIVELLIERENDEM KOPF

Supporti per ogni esigenza di posa

Supports for any installation requirement
Prise en charge de tous les besoins d'installation
Stelzlager für jede Verlegeanforderung

TESTA AUTOLIVELLANTE PER PAVIMENTI IN CERAMICA

Testa da utilizzare per la posa di pavimenti in ceramica, dotata di alette facilmente removibili per fughe da 2, 3 e 4 mm e di gomma antirumore e antiscivolo termosaldata per un maggior comfort acustico e la massima stabilità.

SELF-LEVELLING HEAD FOR CERAMIC FLOORS

Head to be used for the installation of ceramic floors, equipped with easily removable tabs for 2, 3 and 4 mm joints and noise-proof, anti-slip, heat-sealed rubber for a greater acoustic comfort and maximum stability.

TÊTE AUTONIVELANTE POUR SOLS EN CÉRAMIQUE

Tête à utiliser pour la pose de sols en céramique, équipée d'ailettes facilement amovibles pour les joints de 2, 3 et 4 mm et de caoutchouc antibruit et antidérapant thermocollant pour un plus grand confort acoustique et une stabilité maximale.

SELBSTNIVELLIERENDER KOPF FÜR KERAMIK- UND NATURWERKSTEINBÖDEN

Der Kopf zur Verlegung von Keramik- oder Naturwerksteinplatten ist mit leicht entfernbaren Abstandshaltern für 2, 3 und 4 mm breite Fugen und mit heißversiegeltem, geräuschkämpfendem und rutschfestem Gummibelag versehen, der eine bessere Schalldämmung und maximale Stabilität des Bodens bewirkt.



201022
201023
201024

TESTA FISSA PER PAVIMENTI IN CERAMICA

Testa fissa da utilizzare per la posa di pavimenti in ceramica, dotata di alette facilmente removibili per fughe 4 mm. Ideale per pavimentazioni su superfici piane o nei casi in cui il pavimento debba essere parallelo alla superficie su cui poggia il supporto.

FIXED HEAD FOR CERAMIC FLOORS

Fixed head to be used for the installation of ceramic floors, equipped with easily removable tabs for 4 mm joints. It is ideal for floor coverings on flat surfaces or when the floor covering must be parallel to the surface on which the support lays.

TÊTE FIXE POUR SOLS CÉRAMIQUES

Tête fixe à utiliser pour la pose de sols céramiques, équipée d'ailettes facilement amovibles pour des joints de 4 mm. Idéale pour les revêtements de sol sur des surfaces planes ou lorsque le revêtement de sol doit être parallèle à la surface sur laquelle il repose.

FESTES KOPFSTÜCK FÜR KERAMIKBÖDEN

Fester Kopf für die Verlegung von Keramikböden, ausgestattet mit leicht abnehmbaren Lamellen für 4 mm Fugen. Ideal für Bodenbeläge auf ebenen Flächen oder wenn der Bodenbelag parallel zu der Fläche, auf der er liegt, verlegt werden muss.



201025

TESTA AD INCROCIO PER TRAVETTI IN ALLUMINIO

Testa ad incrocio da utilizzare con appositi travetti in alluminio, per la posa di pavimenti sopraelevati con listoni in ceramica mono- e multi-formato. Con questi travetti, dotati di binario per il posizionamento dei distanziatori, è possibile creare una sottostruttura capace di aumentare la stabilità e la portata.

CRISSCROSS HEAD FOR ALUMINIUM JOISTS

Crisscross head to be used with special aluminium joists, for the installation of raised floors with single- and multi-format ceramic planks. With these joists, equipped with a rail for positioning the spacers, it is possible to create a substructure that increases stability and load-bearing capacity.

TRAVERSE POUR LAMBOURDES EN ALUMINIUM

Solution idéale pour la pose de planchers surélevés avec des planches en céramique, à la fois mono et multi-format, à utiliser avec des lambourdes spéciales en aluminium équipées d'un rail pour l'entretoise. Avec ces solives, il est possible de créer une sous-structure capable d'augmenter la stabilité et la capacité de charge.

KREUZKOPF FÜR ALUMINIUMTRÄGER

Der Kreuzkopf eignet sich für die Montage von speziellen Aluminiumprofilen für die Verlegung von aufgestellten Bodenbelägen mit ein- und mehrformatigen Keramikdielen. Mit diesen Profilen, die mit einer Schiene zur Positionierung der Abstandshalter ausgestattet sind, kann eine Tragwerkstruktur erstellt werden, die die Stabilität und Tragfähigkeit erhöht.



201026



1. PP level DUO MAXI con testa autolivellante (cod. 201022, 201023, 201024) per la posa di pavimenti in ceramica.

PP level DUO MAXI with self-levelling head (cod. 201022, 201023, 201024) for the installation of ceramic floors.

PP level DUO MAXI avec tête autonivelante (cod. 201022, 201023, 201024) pour la pose de sols en céramique.

PP level DUO MAXI mit dem selbstnivellierenden Kopf (cod. 201022, 201023, 201024) für die Verlegung von Keramik- und Naturwerksteinplatten.



2. Sistema PP level DUO MAXI con testa ad incrocio (cod. 201026) e travetti in alluminio (cod. 201027) per la posa di listoni in ceramica mono e multi-formato.

PP level DUO MAXI system with crisscross head (cod. 201026) and aluminium joists (cod. 201027) for the installation of single- and multi-format ceramic planks.

Système PP level DUO MAXI avec tête de croisement (cod. 201026) et solives en aluminium (cod. 201027), pour la pose de planches céramiques mono et multiformat.

PP level DUO MAXI-System mit Kreuzkopf (cod. 201026) und Aluminiumprofilen (cod. 201027) zur Verlegung von ein- und mehrformatigen Keramikdielen.



3. Sistema PP level DUO MAXI con testa ad incrocio (cod. 201026) e travetti in alluminio (cod. 201027) trasversali, per una maggiore stabilità in caso di altezze superiori a 40 cm.

PP level DUO MAXI system with crisscross head (cod. 201026) and aluminium crosswise joists (cod. 201027), for greater stability at heights above 40 cm.

Système PP level DUO MAXI avec tête de croisement (cod. 201026) et solives transversales en aluminium (cod. 201027), pour une plus grande stabilité en cas de hauteurs supérieures à 40 cm.

Das PP level DUO MAXI-System mit Kreuzkopf (cod. 201026) und Aluminiumprofilen (cod. 201027) sorgt für zusätzliche Stabilität bei Höhen über 40 cm.

Supporti di basso spessore

Low-thickness supports
Supports de faible épaisseur
Dünne Stelzlager

SUPPORTO REGOLABILE A BASSO SPESSORE PP LEVEL MINI (FINO A 30 MM)

LOW-THICKNESS ADJUSTABLE SUPPORT PP LEVEL MINI (UP TO 30 MM)
SUPPORT RÉGLABLE DE FAIBLE ÉPAISSEUR PP LEVEL MINI (JUSQU'À 30 MM)
DÜNNE HÖHENVERSTELLBARE STELZLAGER PP LEVEL MINI (BIS 30 MM)



PP level MINI (cod. 201032) è un **supporto regolabile a testa fissa** e per altezze fino a 30 mm, a completamento della gamma. PP level MINI è regolabile in altezza da 10 a 15 mm, ma è ulteriormente estensibile fino a 30 mm inserendo un massimo di tre **prolunghe** (cod. 201033) da 5 mm ciascuna. PP level MINI è dotato di alette distanziatrici per fughe da 4 mm, facilmente removibili.

PP level MINI (cod. 201032) is an **adjustable, fixed-head support** for heights up to 30 mm, completing the range. PP level MINI is height-adjustable from 10 to 15 mm, but can be further extended up to 30 mm by inserting a maximum of three **extensions** (cod. 201033) of 5 mm each. PP level MINI is equipped with easily removable spacer tabs for 4 mm joints.

PP level MINI (cod. 201032) est un **support réglable avec tête fixe** et pour des hauteurs allant jusqu'à 30 mm, complétant la gamme. PP level MINI est réglable en hauteur de 10 à 15 mm, mais peut encore être extensible jusqu'à 30 mm en insérant un maximum de trois **rallonges** (cod. 201033) de 5 mm chacune. PP Level MINI est équipé d'ailettes d'espacement pour joints de 4 mm, facilement amovibles.

PP level MINI (201032) ist ein **verstellbares Stelzlager** mit festem Kopf für Höhen bis 30 mm, der das Sortiment ergänzt. Der PP level MINI ist von 10-15 mm höhenverstellbar und kann durch die Verwendung von max. drei Höhenadapter (cod. 201033) von je 5 mm auf bis zu 30 mm erweitert werden. Die Abstandshalter am PP Level MINI Kopf sind für 4 mm breite Fugen und leicht zu entfernen.

SUPPORTO AD ALTEZZA FISSA SP

FIXED-HEIGHT SUPPORT SP
SUPPORT À HAUTEUR FIXE SP
STELZLAGER MIT FESTER HÖHE SP



SP (cod. 201034) è un **supporto con altezza fissa** 14 mm. È la soluzione più semplice ed economica per la posa di qualsiasi pavimentazione da esterno autoportante. A seconda della conformazione del sottofondo, può essere utilizzato con i **livellatori** cod. 201035 (h. 1 mm) e cod. 201036 (h. 3 mm).

SP (cod. 201034) is a **support with fixed height** of 14 mm. It is the simplest and cheapest solution for installing any self-supporting outdoor flooring. According to the conformation of the subfloor, it can be used with **levellers** with cod. 201035 (h. 1 mm) and 201036 (h. 3 mm).

SP (cod. 201034) est un **support d'une hauteur fixe** de 14 mm. C'est la solution la plus simple et la plus économique pour la pose de tout revêtement de sol extérieur autoportant. Selon la forme du support, il peut être utilisé avec **les niveleurs** cod. 201035 (1 mm d'épaisseur) et 201036 (3 mm d'épaisseur).

SP (cod. 201034) ist ein **Stelzlager** mit einer festen Höhe von 14 mm. Dies ist die einfachste und wirtschaftlichste Lösung für die Stelzlagerverlegung im Außenbereich. Je nach Untergrundanforderung können die **Nivellierelemente** cod. 201035 (1 mm Höhe) und 201036 (3 mm Höhe) kombiniert werden.

Accessori per la posa

Accessories for installation
Accessoires d'installation
Verlegezubehör

CHIAVE DI REGOLAZIONE

ADJUSTMENT KEY
CLE DE REGLAGE
JUSTIERSCHLÜSSEL



Grazie all'**apposita chiave**, i supporti PP level DUO MAXI con testa autolivellante per pavimenti in ceramica possono essere regolati in altezza anche a pavimento finito, per ottenere pavimentazioni perfettamente livellate. Per una regolazione più rapida, è disponibile un inserto in acciaio per avvitatore.

Thanks to the **special key**, PP level DUO MAXI supports with self-levelling head for ceramic floors can be adjusted in height even when the floor is finished, to achieve perfectly level floors. For faster adjustment, a steel insert for screwdriver drills is available.

Grâce à la **clé spéciale**, les supports PP level DUO MAXI avec tête autonivelante pour sols en céramique peuvent être réglés en hauteur même lorsque le sol est terminé, pour obtenir des sols parfaitement nivelés. Pour un réglage plus rapide, un insert en acier pour tournevis est disponible.

Die **Höhenjustierung** der mit PP level DUO MAXI Stelzlager mit selbstnivellierendem Kopf verlegten Platten kann dank des speziellen Justierschlüssels auch bei bereits verlegten Bodenbelägen vorgenommen werden. So lassen sich absolut ebene Bodenbeläge erzielen. Für eine schnellere Höhennivellierung ist ein Bohrmaschinenaufsatz aus Stahl erhältlich.

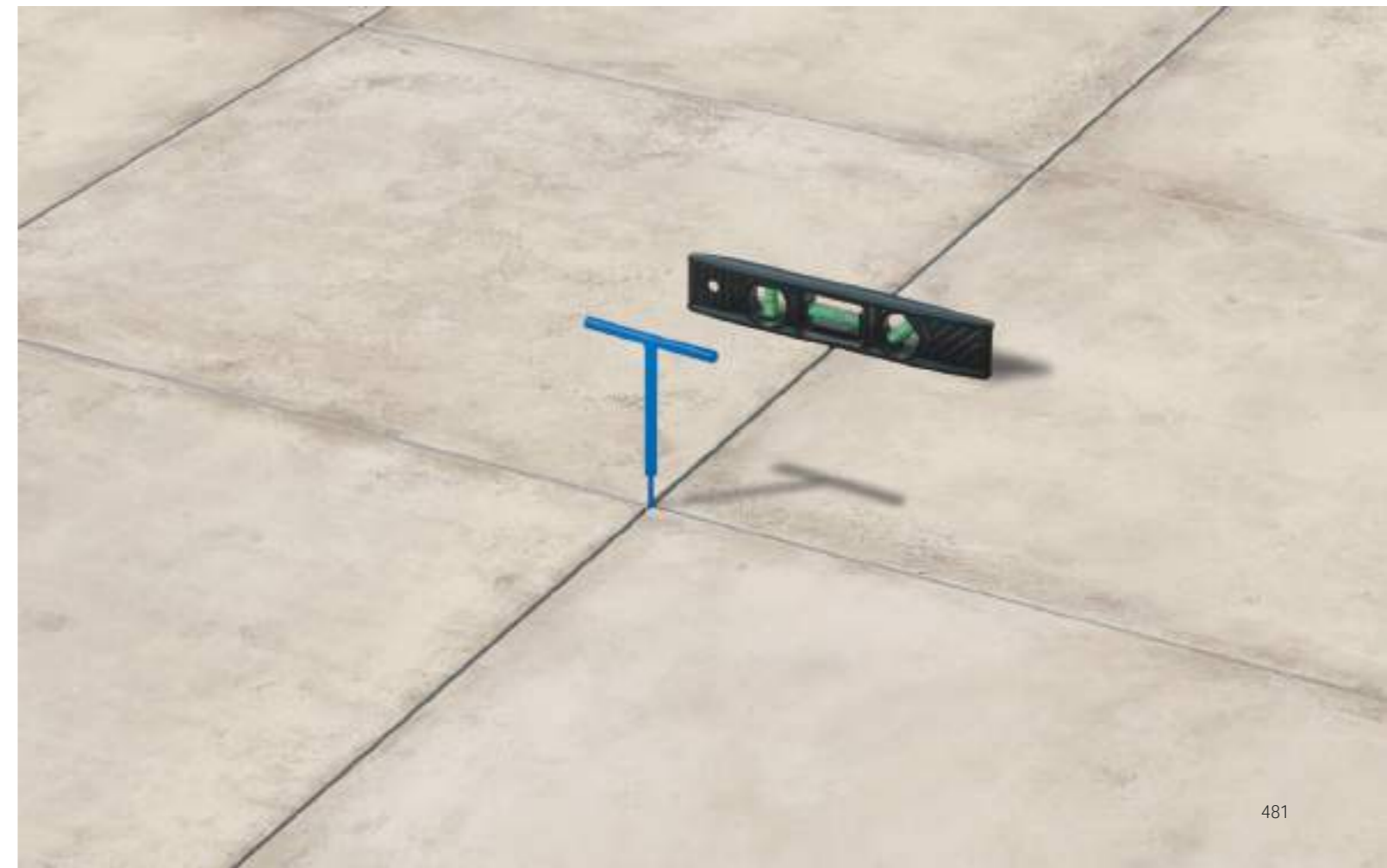

ACCESSORI PER LA POSA

Accessories for installation
Accessoires d'installation
Verlegezubehör

CLIP PER LA CHIUSURA VERTICALE

CLIPS FOR VERTICAL CLOSURE
CLIP POUR FERMETURE VERTICALE
CLIPHALTERUNGEN FÜR VERTIKALE VERBLENDPLATTEN



201039

201040



Gli articoli con **cod. 201039** e **201040** sono due **kit di clip in acciaio inox** (testa+base) per il tamponamento verticale e angolare di pavimenti sopraelevati con piastrelle di 20 mm di spessore.

*The items with **cod. 201039** and **201040** are two stainless steel clip kits (head + base) for vertical and angular closure of raised floors with 20 mm thick tiles.*

*Les articles avec le **cod. 201039** et **201040** sont deux kits de clips en acier inoxydable (tête + base) pour la fermeture verticale et angulaire de planchers surélevés avec des carreaux de 20 mm d'épaisseur.*

*Die Artikel mit den **Artikelnummern 201039** und **201040** sind zwei **Kits aus Edelstahl-Clips** (Kopf + Sockel) für die Lineare und Ecksicherung von Verblendplatten für den Abschluss der vertikalen Stirnseiten bei der Stelzlagerverlegung für Plattendicken bis 20 mm.*

DISTANZIATORE PERIMETRALE

PERIMETER SPACER
ESPACEUR PERIMETRAL
WANDABSTANDSHALTER



201041

201042



Gli articoli con **cod. 201041** e **201042** sono **due clip**, rispettivamente in **acciaio inox** e in **polipropilene**, entrambe con funzione di distanziatore perimetrale, per ottenere fughe uniformi e lineari tra le piastrelle e il muro perimetrale.

*The items with **cod. 201041** and **201042** are two clips, in stainless steel and polypropylene respectively, both with perimeter spacer function, to obtain uniform and linear joints between the tiles and the perimeter wall.*

*Les articles avec le **cod. 201041** et **201042** sont deux clips, respectivement en acier inoxydable et en polypropylène, tous deux avec fonction d'entretoise périmétrale, pour obtenir des joints uniformes et linéaires entre les carreaux et le mur d'enceinte.*

*Die Artikel mit den **Artikelnummern 201041** und **201042** sind zwei **Clips aus Edelstahl bzw. Polypropylen**, zur Sicherstellung einer geraden, ausreichend breiten Anschlussfuge zu den aufgehenden Bauteilen.*

ACCESSORI PER LA POSA

Accessories for installation
Accessoires d'installation
Verlegezubehör

TAPPETINO IN GOMMA

RUBBER MAT
TAPIS DE CAOUTCHOUC
GUMMIPAD



L'articolo con **cod. 201043** è un **tappetino in gomma** con diametro di 21 cm e spessore di 2 mm con funzione di abbattimento acustico.

*The item with **cod. 201043** is a rubber mat with a diameter of 21 cm and a thickness of 2 mm with anti-noise function.*

*L'article avec le **cod. 201043** est un tapis en caoutchouc d'un diamètre de 21 cm et d'une épaisseur de 2 mm avec fonction de réduction du bruit.*

*Der Artikel mit der **Artikelnummer 201043** ist ein geräuschkämpfendes Gummipad mit einem Durchmesser von 21 cm und einer Dicke von 2 mm.*

DISCO LIVELLANTE PER TESTA

LEVELLING DISK FOR HEAD
DISQUE DE NIVELLEMENT POUR TÊTE
NIVELLIERELEMENT FÜR DEN KOPF



L'articolo con **cod. 201044** è un **disco livellante in gomma** da posizionare sulla testa del supporto per spessorare uno o più settori e compensare piastrelle con spessori non omogenei.

*The item with **cod. 201044** is a rubber levelling disk to be placed on the support head to shim one or more sectors and correct tiles with uneven thicknesses.*

*L'article avec le **cod. 201044** est un disque de nivellement en caoutchouc à placer sur la tête du support pour épaissir un ou plusieurs secteurs et compenser les carreaux d'épaisseurs non homogènes.*

*Der Artikel mit der **Artikelnummer 201044** ist ein **Nivellierelement aus Gummi**, das am Kopf der Stelzlagerstütze platziert wird, um einen oder mehrere Bereiche des Kopfes aufzupolstern und damit ungleichmäßige Fliesendicken auszugleichen.*

DISCO LIVELLANTE PER BASE

LEVELLING DISK FOR BASE
DISQUE DE NIVELLEMENT POUR BASE
NIVELLIERSCHEIBE FÜR DEN SOCKEL



L'articolo con **cod. 201045** è un **disco livellante in gomma** da posizionare alla base del supporto per spessorare uno o più settori e compensare eventuali imperfezioni del sottofondo.

*The item with **cod. 201045** is a rubber levelling disk to be placed under the support base to shim one or more sectors and correct any imperfections in the subfloor.*

*L'article avec le **cod. 201045** est un disque de nivellement en caoutchouc à placer à la base du support pour épaissir un ou plusieurs secteurs et compenser les éventuelles imperfections du substrat.*

*Der Artikel mit der **Artikelnummer 201045** ist ein **Nivellierelement aus Gummi**, das unter dem Sockel der Stelzlagerstütze platziert wird, um einen oder mehrere Bereiche zu unterfüllen und damit vorhandene Unebenheiten des Untergrunds auszugleichen.*

La gamma

The range
La gamme
Die Produktpalette



201016
h. 28-39 mm



201017
h. 38-57 mm



201018
h. 56-91 mm



201019
h. 87-150 mm

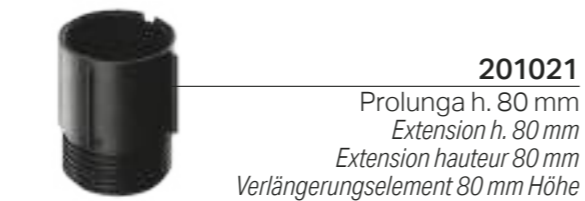

201021
Prolunga h. 80 mm
Extension h. 80 mm
Extension hauteur 80 mm
Verlängerungselement 80 mm Höhe



PP LEVEL DUO MAXI - base + vite
PP LEVEL DUO MAXI - base + screw

cod.	descrizione - description	conf. - pack	pallet
201016	base + vite regolabile da h. 28 a 39 mm base + screw adjustable from h. 28 to 39 mm	24	1152
201017	base + vite regolabile da h. 38 a 57 mm base + screw adjustable from h. 38 to 57 mm	24	1152
201018	base + vite regolabile da h. 56 a 91 mm base + screw adjustable from h. 56 to 91 mm	24	672
201019	base + vite regolabile da h. 87 a 150 mm base + screw adjustable from h. 87 to 150 mm	24	480

no sconfezionamento - no partial packaging



PROLUNGHE PER PP LEVEL DUO MAXI
EXTENSIONS FOR PP LEVEL DUO MAXI

cod.	descrizione - description	conf. - pack	pallet
201020	prolunga h. 10 mm extension h. 10 mm	15	1800
201021	prolunga h. 80 mm extension h. 80 mm	24	960

no sconfezionamento - no partial packaging

201018 + 201021	= 136/195 mm
201019 + 201021	= 167/254 mm
201019 + (2 x 201021)	= 247/358 mm
201019 + (3 x 201021)	= 327/462 mm
201019 + (4 x 201021)	= 407/566 mm
201019 + (5 x 201021)	= 487/671 mm
201019 + (6 x 201021)	= 567/775 mm
201019 + (7 x 201021)	= 647/879 mm
201019 + (8 x 201021)	= 727/983 mm
201019 + (9 x 201021)	= 807/1087 mm
201019 + (10 x 201021)	= 887/1192 mm



PP LEVEL DUO MAXI - Testa autolivellante per pavimenti in ceramica
PP LEVEL DUO MAXI - Self-levelling head for ceramic floors

cod.	descrizione - description	conf. - pack	pallet
201022	testa fuga 2 mm head for 2 mm joints	48	3840
201023	testa fuga 3 mm head for 3 mm joints	48	3840
201024	testa fuga 4 mm head for 4 mm joints	48	3840

no sconfezionamento - no partial packaging



201025

PP LEVEL MAXI FIX - **Testa fissa** per pavimenti in ceramica
PP LEVEL MAXI FIX - **Fixed head** for ceramic floors

cod.	descrizione - description	conf. - pack	pallet
201025	Testa fissa fuga 4 mm Fixed head for 4-mm joints	48	3840

no sconfezionamento - no partial packaging

con testa fissa **cod. 201025** le escursioni delle basi + viti sono da considerarsi inferiori di 3 mm, quindi le altezze saranno:

cod. 201016: da 25 a 36,
cod. 201017: da 35 a 54,
cod. 201018: da 53 a 88,
cod. 201019: da 84 a 147

with fixed head **cod. 201025** the ranges of the bases + screws are to be considered 3 mm lower, therefore the heights will be:

cod. 201016: from 25 to 36,
cod. 201017: from 35 to 54,
cod. 201018: from 53 to 88,
cod. 201019: from 84 to 147



201026



201027



201028



201029

201030



201031

PP LEVEL DUO MAXI - Joist

cod.	descrizione - description	conf. - pack	pallet
201026	testa per travetto in alluminio head for aluminium joist	48	3840
201027	travetto in alluminio naturale L. 240 cm natural aluminium joist L. 240 cm	8	-
201028	distanziatore fuga 4 mm per travetto cod. 201027 4-mm spacer for joist cod. 201027	500	-
201029	gomma antirumore per travetto cod. 201027 rotolo 50 metri noise-proof rubber for joist cod. 201027 - 50 meters roll	1	-
201030	gomma antirumore per travetto cod. 201027 rotolo 200 metri noise-proof rubber for joist cod. 201027 - 200 meters roll	1	-
201031	giunto di raccordo per travetto cod. 201027 connection joint for joist cod. 201027	250	-

no sconfezionamento - no partial packaging



201032



201033

PP LEVEL MINI
Testa fuga/head 4 mm
Alette/tabs h. 10 mm

cod.	descrizione - description	conf. - pack	pallet
201032	supporto regolabile da h. 10 a 15 mm adjustable support from h. 10 to 15 mm	20	-
201033	prolunga h. 5 mm per articolo con cod. 201032 (max 3 prolunghe = + 15 mm) extension h. 5 mm for item with cod. 201032 (max. 3 extensions = + 15 mm)	20	-

no sconfezionamento - no partial packaging



201034



201035



201036

SP Supporti
SP Supports

cod.	descrizione - description	conf. - pack	pallet
201034	supporto ad altezza fissa diam. 155x14 h. fixed height support diam. 155 x 14 h.	360	5760
201035	livellatore per supporto cod. 201034 h. 1 mm leveller for support cod. 201034 - h. 1 mm	1000	20000
201036	livellatore per supporto cod. 201034 h. 3 mm leveller for support cod. 201034 - h. 3 mm	500	15000

no sconfezionamento - no partial packaging

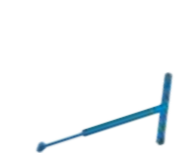

201037



201038



201039



201040



201041



201042

PP LEVEL DUO MAXI - Accessori
PP LEVEL DUO MAXI - Accessories

cod.	descrizione - description	conf. - pack	pallet
201037	chiave di regolazione (per fughe 4 mm) adjustment key (for 4 mm joints)	12	-
201038	inserto per trapano avvitatore insert for screwdriver drill	1	-
201039	clip perimetrale (base + testa) perimeter clip (base + head)	30	-
201040	clip angolare (base + testa) corner clip (base + head)	4	-
201041	clip muro in acciaio inox wall clip in stainless steel	50	-
201042	clip muro in PoliPropilene nero wall clip in polypropylene	200	-
201043	tappetino in gomma diam. cm 21x0,2 sp. rubber mat diam. cm 21 x 0,2 thick.	100	-
201044	disco livellante per testa diam. cm 12x0,2 sp. levelling disk for head diam. cm 12 x 0,2 thick.	100	-
201045	disco livellante per base diam. cm 21x0,2 sp. levelling disk for base diam. cm 21 x 0,2 thick.	100	-

no sconfezionamento (eccetto per chiave di regolazione cod. 201037)
no partial packaging (except for adjustment key cod. 201037)



201043



201044



201045



La posa a secco su erba

Dry laying on grass
La pose à sec sur herbe
Trockenverlegung auf Rasen



I nostri prodotti con spessore 20 mm nascono per integrarsi e resistere negli ambienti esterni. In presenza di un fondo di tipo erboso la posa viene eseguita a secco semplicemente appoggiando le piastrelle. L'opera può essere eseguita senza l'intervento di personale specializzato e senza l'utilizzo di colle per l'edilizia. Quest'ultima caratteristica determina il beneficio di rendere le superfici immediatamente calpestabili. Adatta sia per giardini di abitazioni private che per ampi spazi pubblici, questo tipo di posa permette di modificare i tracciati o le pavimentazioni in qualsiasi momento riutilizzando lo stesso materiale più volte e in luoghi diversi.

Our 20-mm thick products are designed to integrate and withstand outdoor settings.

In the case of a turf surface, the tiles are laid dry by simply placing them on the ground. The work can be carried out without the intervention of skilled personnel and without the use of tile adhesives. The latter feature results in the benefit of making the surfaces immediately walkable. Suitable for both private gardens and large public spaces, this type of laying allows paths or paving to be changed at any time by reusing the same material several times and in different places.

Nos produits en épaisseur 20 mm sont conçus pour s'intégrer et résister dans les ambiances extérieures.

Avec un support de type herbeux, la pose est effectuée à sec, simplement en posant les dalles, sans nécessité de faire intervenir un personnel spécialisé et sans utiliser de colles. Cette dernière caractéristique a l'avantage de permettre un passage immédiat sur les surfaces. Cette pose convient aussi bien pour les habitations privées que pour de grands espaces publics car elle permet de changer les tracés ou les revêtements de sol à tout moment, en réutilisant le même matériel plusieurs fois et en des endroits différents.

Unsere Produkte mit 20 mm Stärke eignen sich dank ihrer Flexibilität und Beständigkeit hervorragend für die Verlegung in Außenbereichen.

Auf Rasen bietet sich die Trockenverlegung an, bei der die Fliesen direkt auf dem Untergrund angeordnet werden. Hierzu ist weder Fachpersonal noch der Rückgriff auf Baustoffe oder -kleber erforderlich. Nach der Verlegung sind die Oberflächen sofort begehbar. Diese Art der Verlegung eignet sich sowohl für Gärten in Privatbesitz als auch für große öffentliche Bereiche; sie bietet den Vorteil, dass die Verläufe oder Bodenbeläge jederzeit geändert werden können, wobei das gleiche Material mehrmals und an verschiedenen Stellen wiederverwendet werden kann.



La posa a secco su ghiaia

Dry laying on gravel
La pose à sec sur gravier
Trockenverlegung auf Kies

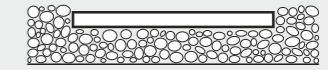

Il Progetto Outdoor presenta una serie di soluzioni per lo sviluppo di interessanti soluzioni estetiche. Un altro sistema di posa proposto è quello su ghiaia, che si esegue semplicemente appoggiando la piastrella spessorata sopra al manto ghiaioso già steso in precedenza. È possibile inoltre arricchire l'effetto decorativo utilizzando della ghiaia di colore o con granulometria diversa. Il substrato di ghiaia garantisce un più facile e veloce livellamento delle piastrelle, una efficace stabilità nel tempo e il drenaggio ottimale delle acque. La posa a secco su ghiaia è calpestabile immediatamente dopo la messa in opera e consente di modificare le pavimentazioni in qualsiasi momento.

The Outdoor Project offers a range of options for the development of interesting aesthetic solutions. Another proposed laying system is on gravel, which can be done by simply placing the thicker tile on top of the previously laid gravel substrate. You can also enhance the decorative effect by using coloured gravel or with a different grain size. The gravel substrate ensures easier and faster levelling of the tiles, effective long-term stability and optimal water drainage. Dry laid tiles on gravel can be walked on immediately after installation and the paving can be modified at any time.

Le projet Outdoor présente une série de solutions pour le développement de solutions esthétiques intéressantes. Un autre système de pose proposé est celui sur gravier: la dalle grande épaisseur est posée directement sur le gravier étalé préalablement. Il est également possible d'accroître l'aspect décoratif en utilisant un gravier coloré ou avec des granulométries différentes. Le support en gravier garantit un nivellement plus facile et plus rapide des dalles, une stabilité dans le temps et le drainage optimale de l'eau. Les dallées posées à sec sur gravier permettent le passage immédiatement après la pose et le revêtement de sol peut être changé à tout moment.

Das Outdoor-Projekt bietet eine Reihe von Möglichkeiten für die Ausarbeitung interessanter ästhetischer Lösungen. Eine weitere Art der Anwendung ist die Trockenverlegung auf Kies; dabei werden die überstarken Fliesen lediglich auf der zuvor vorbereiteten Kiesschicht angeordnet. Zusätzliche dekorative Optionen können mit farbigem Kies oder verschiedenen Korngrößen in Betracht gezogen werden. Die Unterschicht aus Kies garantiert eine leichtere und raschere Nivellierung der Fliesen, langfristige Stabilität und eine optimale Ableitung des Niederschlagswassers. Nach der Trockenverlegung auf Kies sind die Oberflächen sofort begehbar, und die Beläge können jederzeit und je nach Belieben modifiziert werden.





La posa a secco su sabbia

Dry laying on sand
La pose à sec sur sable
Trockenverlegung auf Sand

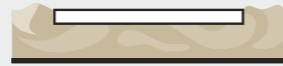

Le caratteristiche fisiche e tecniche dello spessore 20 mm del progetto Outdoor si adattano perfettamente in presenza di fondi sabbiosi. Tali caratteristiche possono essere particolarmente convenienti per gli stabilimenti balneari. La superficie antiscivolo consente di realizzare pedane di servizio e camminamenti percorribili in sicurezza, **resiste al contatto prolungato con il sale e non altera l'aspetto** anche se esposta costantemente ai raggi solari. La posa si esegue a secco semplicemente appoggiando le lastre sul fondo sabbioso senza la presenza di personale specializzato. I camminamenti sono **immediatamente calpestabili** e possono essere modificati, rimossi e riutilizzati secondo le esigenze in qualsiasi momento.

The physical and technical features of the 20 mm thickness of the Outdoor project are perfectly suited to sandy surfaces. Such features can be particularly convenient for beach resorts. The anti-slip surface makes it possible to create safe service decks and walkways, resists prolonged contact with salt and does not alter its appearance even when constantly exposed to sunlight. The slabs are laid dry by simply placing them on the sandy bottom without the need of skilled personnel. The walkways can be immediately walked on and can be modified, removed and reused as required at any time.

Les caractéristiques physiques et techniques de l'épaisseur 20 mm du projet Outdoor s'adaptent parfaitement aux supports sableux. Ces caractéristiques peuvent être particulièrement avantageuses pour les établissements balnéaires. La surface anti-glissement permet de réaliser des plateformes de service et des chemins sur lesquels marcher en toute sécurité, elle résiste au contact prolongé avec le sel et son aspect ne s'altère pas même si elle est exposée en permanence à la lumière du soleil.

La pose s'effectue à sec, simplement en posant les dalles sur le sable sans nécessité de faire intervenir un personnel spécialisé. Les chemins peuvent être immédiatement empruntés et peuvent être modifiés, supprimés ou réutilisés à tout moment selon les exigences.

Mit ihren physischen und technischen Merkmalen sind die 20 mm starken Fliesen des Outdoor-Projekts die perfekte Wahl auch bei sandigen Untergründen. Somit eignen sie sich hervorragend zur Nutzung in Badeanstalten und an Strandeinrichtungen. Dank der rutschhemmenden Oberfläche können trittsichere Podeste für das Strandpersonal und Gehwege eingerichtet werden, und selbst der längere Kontakt mit Salz und eine ständige Sonneneinstrahlung bewirken keine Veränderungen am Aussehen des Materials. Zur Trockenverlegung werden die Fliesen lediglich auf dem sandigen Untergrund angeordnet, ohne das hierzu Fachpersonal erforderlich ist. Die Gehwege können unmittelbar nach der Erstellung betreten und jederzeit und je nach Anforderung geändert, entfernt und wiederverwendet werden.



La posa a colla su massetto

Adhesive application on screed
La pose avec colle sur chape
Verlegung mit Kleber auf Unterbetonblock (Estrich)



Dall'abbinamento della posa a colla su massetto tradizionale con le piastrelle a spessore 20 mm è possibile creare pavimenti da outdoor con elevate prestazioni tecniche. Sono pavimentazioni caratterizzate da una **perfetta stabilità del fondo** e un'**eccezionale resistenza ai carichi di rottura** concepite per superfici sottoposte al **passaggio e alla sosta di autoveicoli** o per **aree altamente frequentate** quali marciapiedi, piste ciclabili o camminamenti pedonali.

The combination of adhesive laying on a traditional screed with 20-mm thick tiles makes it possible to create outdoor pavings with high technical performance. These pavements are characterised by perfect stability of the background and very high resistance to breaking loads, designed for surfaces subject to the passage and parking of motor vehicles or for areas with high traffic, such as pavements, cycle lanes or pedestrian walkways.

En associant la pose collée traditionnelle sur chape avec les dalles en 20 mm d'épaisseur, il est possible de créer des sols d'extérieur offrant des performances techniques élevées. Ces sols sont caractérisés par une stabilité parfaite du support et une exceptionnelle résistance aux charges de rupture étudiées pour des surfaces soumises au passage et au stationnement de véhicules ou pour des espaces très fréquentés comme des trottoirs, des pistes cyclables ou des chemins piétonniers.

Die Verlegung mit Kleber von 20-mm-Fliesen auf einem traditionellen Unterbetonblock (Estrich) ist die ideale Ausgangssituation für Outdoor-Bodenbeläge mit ausgezeichneten technischen Performances. Neben der perfekten Stabilität des Untergrunds ist die außergewöhnliche Bruchfestigkeit ein entscheidendes Merkmal, dank dessen sich die Bodenbeläge nicht nur für Fahr- und Parkflächen von Fahrzeugen, sondern auch für stark frequentierte Bereiche wie Bürgersteige, Fahrrad- und Gehwege eignen.

VORTEILE

- Langzeitliche Stabilität
- Ideal für befahrene Flächen
- Beständig gegen Belastung bei intensiver Begehung

ANWENDUNGSEMPFEHLUNGEN

- Höfe
- Auf- und Abfahrtsrampen
- Garagen, Parkplätze
- Halteplätze
- Fahrradwege
- Gehwege
- Bürgersteige
- Arkaden
- Terrassen

Vantaggi

- **Garantisce stabilità nel tempo**
- **Ideale per superfici carrabili**
- **Sopporta le sollecitazioni del calpestio intenso**

Collocazioni Consigliate

- Cortili
- Rampe di accesso
- Garage, parcheggi
- Aree di sosta
- Piste ciclabili
- Camminamenti
- Marciapiedi
- Porticati
- Terrazzi

ADVANTAGES

- Guaranteed stability over time
- Ideal for areas open to vehicle traffic
- Withstands high footfall

RECOMMENDED LOCATIONS

- Courtyards
- Access ramps
- Garages, car parks
- Short-stay sites for vehicles
- Cycle paths
- Walkways
- Pavements
- Arcades/porches
- Terraces

AVANTAGES

- Stabilité garantie au fil du temps
- Idéale pour les surfaces carrossables
- Supporte les sollicitations dérivant du piétinement intense

EMPLACEMENTS CONSEILLÉS

- Cours
- Rampes d'accès
- Garage, parkings
- Zones de stationnement
- Pistes cyclables
- Allées
- Trottoirs
- Porches
- Terrasses

20MM R11C

I Pezzi Speciali

Trims

Les pièces spéciales

Die Sonderstücke

Il progetto Outdoor a marchio LA FABBRICA AVA si rivela uno strumento raffinato ed articolato per tutte le progettazioni di spazi esterni, anche le più articolate.

Richiedibili su richiesta, nella gamma dei nostri prodotti Outdoor è presente una serie completa di pezzi speciali ottenuti dal fondo 20 mm per rifinire piscine, giardini e, in generale, lo spazio del tuo ambiente outdoor.

LA FABBRICA AVA branded Outdoor project is a styled and articulated tool for all outdoor design projects, even the most complex ones. Our Outdoor product range includes a complete series of special pieces made from 20 mm background to finish swimming pools, gardens and, in general, your outdoor space.

All these pieces are available on request.

Le projet Outdoor de LA FABBRICA AVA est un outil raffiné et modulaire pour tous les projets d'espaces extérieurs, même les plus articulés. La gamme de nos produits Outdoor offre une série complète de pièces spéciales, disponibles sur demande, obtenues à partir du fond en 20 mm pour la finition de piscines, jardins et, plus généralement, de vos espaces extérieurs.

Das Outdoor-Projekt der Marke LA FABBRICA AVA erweist sich als raffiniertes und vielseitiges Instrument, wenn es darum geht, Außenbereiche - auch sehr komplexe - zu gestalten und einzurichten.

Auf Anfrage kann im Rahmen des Angebots unserer Outdoor-Produkte eine vollständige Serie von 20-mm-Sonderstücken für abschließende Verlegungen an Swimmingpools, in Gärten und allgemein in Außenbereichen angefordert werden.

- 1 **GRADONE COSTA RETTA**
Large step - straight edge
- 2 **GRADONE ANGOLO DX/SX COSTA RETTA**
Large step corner R-L - straight edge
- 3 **GRADONE COSTA TORO**
Large step - bullnose edge
- 4 **GRADONE ANGOLO DX/SX COSTA TORO**
Large step corner R-L - bullnose edge
- 5 **GRIGLIA**
Drainage grig
- 6 **GRIGLIA ANGOLO DX/SX COSTA TORO**
Drainage grig corner R-L
- 7 **ANGOLO CURVILINEO**
Curved shaped corner

I Pezzi Speciali

Trims / Les pièces spéciales / Die Sonderstücke

FORMATO DELLA SERIE Main size of the series 40x120 • Amazon • Ardesia • Ca' Foscari • Dolomiti • Honey Wood • Il Cerreto	Gradone 40x120	Gradone angolo DX/SX 40x120	Copertina rettilinea 30x60	Angolo curvilineo interno 40x40 - r 10
	A: 1200mm B: 400mm	A: 1200mm B: 400mm	A: 600mm B: 300mm	A: 400mm B: 300mm r: 10
	 P211 P219	 P239 P251	 P201	 P303 P305
	Griglia 20x80	Griglia angolo DX/SX 20x80	Griglia 20x60	Griglia angolo DX/SX 20x60
	A: 800mm B: 200mm	A: 800mm B: 200mm	A: 600mm B: 200mm	A: 600mm B: 200mm r: 10

FORMATO DELLA SERIE Main size of the series 100x100 • Chianca • Hurban • Pierres des Châteaux • Royal Stone • Skyline	Gradone 50x100	Gradone angolo DX/SX 50x100	Copertina rettilinea 30x100	Angolo curvilineo interno 50x50 - r 10
	A: 1000mm B: 500mm	A: 1000mm B: 500mm	A: 1000mm B: 300mm	A: 500mm B: 500mm r: 10
	 P225 P235	 P245 P253	 P303	 P337 P311
	Angolo curvilineo 100x100	Angolo curvilineo 100x100	Griglia 20x100	Griglia angolo DX/SX 20x100
	A: 1000mm B: 1000mm r: 15	A: 1000mm B: 1000mm r: 30	A: 1000mm B: 200mm	A: 1000mm B: 200mm
	 P423 P423	 P423 P423	-	-

A disposizione solo su richiesta. Tempi di consegna: 30gg
 Available upon request only. Delivery terms: 30 days
 Disponible seulement sur requête. Délais de livraison: 30 jours
 Verfügbar auf Anfrage. Lieferzeit: 30 Tage

I pezzi speciali H2o sono realizzati con un bordo smaltato resistente per esterni.

H2O trims are made with a durable glazed edge suitable for outdoor use.

Les pièces spéciales en H2O sont fabriquées avec un bord émaillé résistant pour une utilisation en extérieur.

Die speziellen H2O-Stücke sind mit einem widerstandsfähigen glasierten Rand für den Außenbereich hergestellt.













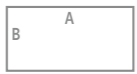





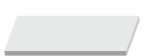



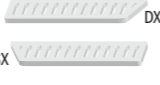
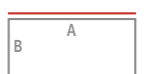



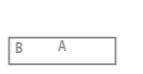



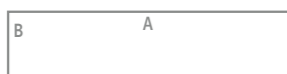
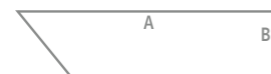
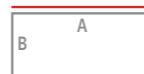

FORMATO DELLA SERIE Main size of the series 80x80 • Agglomerate • Ardesia • Blue Evolution • Space • Storm	Gradone 40x80	Gradone angolo DX/SX 40x80	Copertina rettilinea 30x80	Angolo curvilineo interno 40x40 - r 10
	A: 800mm B: 400mm	A: 800mm B: 400mm	A: 800mm B: 300mm	A: 400mm B: 400mm r: 10
	 P175 P181	 P197 P203	 P275	 P303 P311
	Angolo curvilineo 80x80	Griglia 20x80	Griglia angolo DX/SX 20x80	
	A: 800mm B: 800mm r: 15	A: 800mm B: 200mm	A: 800mm B: 200mm	
	 P423 P423	-	-	

A disposizione solo su richiesta. Tempi di consegna: 30gg
 Available upon request only. Delivery terms: 30 days
 Disponible seulement sur requête. Délais de livraison: 30 jours
 Verfügbar auf Anfrage. Lieferzeit: 30 Tage

I Pezzi Speciali

Trims / Les pièces spéciales / Die Sonderstücke

FORMATO DELLA SERIE Main size of the series 60x60 • I Quarzi • Royal Stone • Storm	Gradone 30x60 		Gradone angolo DX/SX 30x60 			
						
	A: 600mm B: 300mm		A: 600mm B: 300mm			
		P135		P145		
		P135		P151		
	Copertina rettilinea 30x60 	Angolo curvilineo 60x60 - r 15 	Griglia 30x60 	Griglia angolo DX/SX 30x60 	Griglia 15x60 	Griglia angolo DX/SX 15x60 
						
	A: 600mm B: 300mm	A: 600mm B: 600mm r:15	A: 600mm B: 300mm	A: 600mm B: 300mm	A: 600mm B: 150mm	A: 600mm B: 150mm
		P197	-	-	-	-

FORMATO DELLA SERIE Main size of the series 60x120 • Noble Stone	Gradone 30x120 		Gradone angolo DX/SX 30x120 		Copertina rettilinea 30x60 		Angolo curvilineo 60x60 - r 15 	
								
	A: 1200mm B: 300mm		A: 1200mm B: 300mm		A: 600mm B: 300mm		A: 600mm B: 600mm r: 10	
		P215		P239		P211		P319
		P221		P251				P319

I pezzi speciali H2o sono realizzati con un bordo smaltato resistente per esterni.

H2O trims are made with a durable glazed edge suitable for outdoor use.

Les pièces spéciales en H2O sont fabriquées avec un bord émaillé résistant pour une utilisation en extérieur.

Die speziellen H2O-Stücke sind mit einem widerstandsfähigen glasierten Rand für den Außenbereich hergestellt.

A disposizione solo su richiesta. Tempi di consegna: 30gg

Available upon request only. Delivery terms: 30 days

Disponible seulement sur requête. Délais de livraison: 30 jours

Verfügbar auf Anfrage. Lieferzeit: 30 Tage

GRIGLIA
Drainage grid

GRADONE
Large step

GRIGLIA ANGOLO
DESTRO E SINISTRO
Drainage grid - corner L/R

GRADONE ANGOLO
DESTRO E SINISTRO
Large Step - corner L/R

GRADONE
Large Step

Imballi Lastre / Slabs Packaging

Cavalletti A-frame

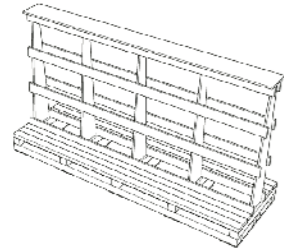

WOOD A-FRAME

INGOMBRO - SIZE: 330x75x193,5 CM
TARA - TARE: 177,50 KG

cod. 202011

Tiles dimension
324x163 | 22 pieces
320x160 | 44 pieces

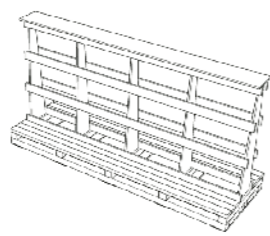

WOOD A-FRAME

INGOMBRO - SIZE: 290x75x161 CM
TARA - TARE: 145 KG

cod. 202009

Tiles dimension
280x120 | 44 pieces

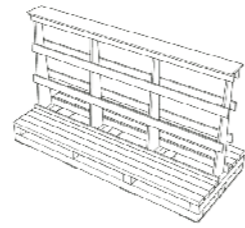

WOOD A-FRAME

INGOMBRO - SIZE: 250x75x161 CM
TARA - TARE: 132 KG

cod. 202010

Tiles dimension
240x120 | 44 pieces

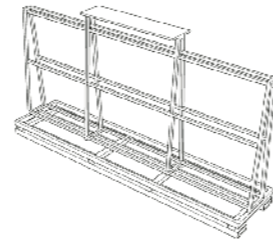

IRON A-FRAME

INGOMBRO - SIZE: 330x75x193,5 CM
TARA - TARE: 130 KG

cod. 202012

Tiles dimension
324x163 | 22 pieces

Cassa in legno Wood crate

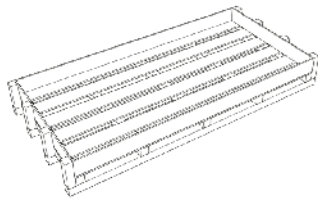

INGOMBRO - SIZE: 345x175x37 CM
TARA - TARE: 140 KG

cod. 202002

Tiles dimension
163x324 | 10 pieces
160x320 | 14 pieces

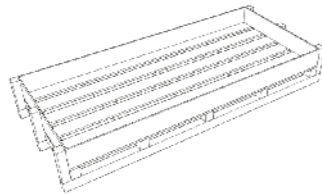

INGOMBRO - SIZE: 292x145x35 CM
TARA - TARE: 108 KG

cod. 202005

Tiles dimension
120x280 | 20 pieces

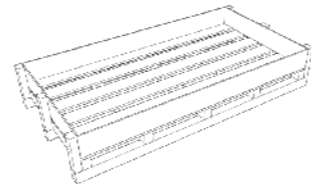

INGOMBRO - SIZE: 264x136x40 CM
TARA - TARE: 100 KG

cod. 202001

Tiles dimension
120x240 | 20 pieces

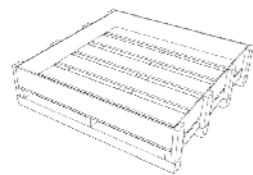

INGOMBRO - SIZE: 182,6x173,6x40,4 CM
TARA - TARE: 80 KG

cod. 202003

Tiles dimension
160x160 | 24 pieces

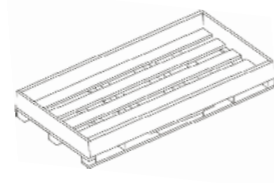

INGOMBRO - SIZE: 252x94x30,4 CM
TARA - TARE: 85 KG

cod. 202006

Tiles dimension
24x240 | 54 pieces
40x240 | 36 pieces

Imballi / Packaging

Paletta Pallet

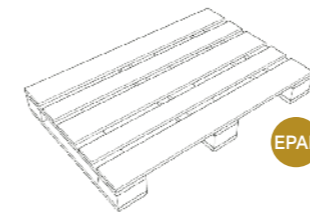

INGOMBRO - SIZE: 120x80x14,4 CM
TARA - TARE: 22 KG

Tiles dimension
20x120 | 30x120 | 40x120
30x60 | 60x60 | 60x120
20x40 | 40x40 | 40x60
10x30

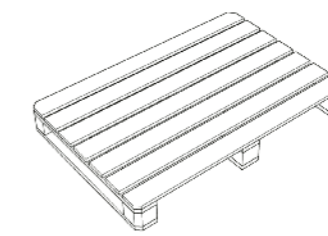

INGOMBRO - SIZE: 120x96x13,6 CM
TARA - TARE: 20 KG

Tiles dimension
60x120 Lapp

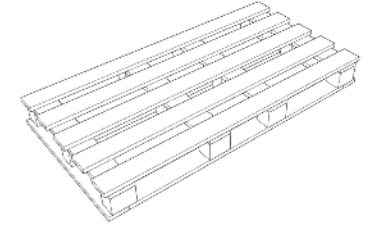

INGOMBRO - SIZE: 152x77,6x16,1 CM
TARA - TARE: 20 KG

Tiles dimension
23,4x148

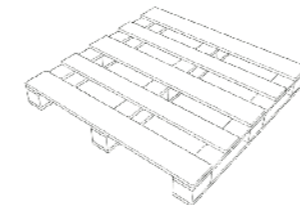

INGOMBRO - SIZE: 103x103x15 CM
TARA - TARE: 22 KG

Tiles dimension
100x100 h20

Pallet con sponde Pallet with sides

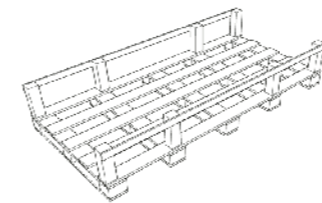

INGOMBRO - SIZE: 184x97x45 CM
TARA - TARE: 36 KG

Tiles dimension
80x180 | 40 pieces

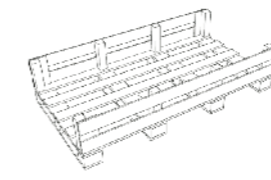

INGOMBRO - SIZE: 168x97x40,9 CM
TARA - TARE: 29,4 KG

Tiles dimension
80x160 | 30 pieces

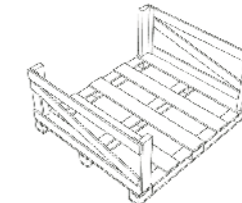

INGOMBRO - SIZE: 123x143x74 CM
TARA - TARE: 29 KG

Tiles dimension
120x120 | 48 pieces

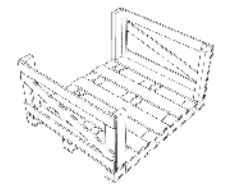

INGOMBRO - SIZE: 103x123x70 CM
TARA - TARE: 30 KG

Tiles dimension
100x100 h8,8 | 48 pieces

Caratteristiche tecniche

Technical features / Caracteristiques techniques / Technische eigenschaften

Classificazione secondo UNI EN 14411 - ISO 13006 - G - Bla (E ≤ 0,5%) UGL

Product in compliance with UNI EN 14411 - ISO 13006 - G - Bla (E ≤ 0,5%) UGL

Classement selon UNI EN 14411 - ISO 13006 - G - Bla (E ≤ 0,5%) UGL

Klassifizierung nach UNI EN 14411 - ISO 13006 - G - Bla (E ≤ 0,5%) UGL

	CARATTERISTICA SPECIFICATION CARACTERISTIQUE EIGENSCHAFT	METODO DI PROVA TEST METHODS METHODE D'ESSAI TESTVERFAHREN	VALORE PRESCRITTO FIXED VALUE VALEUR PRESCRITE VORGESCHRIEBENER WERT		
	CARATTERISTICHE DIMENSIONALI DIMENSIONS AND SURFACE QUALITY DIMENSIONS DIMENSIONALE EIGENSCHAFTEN	ISO 10545-2	LUNGHEZZA E LARGHEZZA LENGTH AND WIDTH. LONGUEUR ET LARGEUR. LÄNGE UND BREITE	±0.6% or ±2mm	CONFORME COMPLIANT CONFORME ERFÜLLT
			SPESSORE THICKNESS. EPAISSEUR. STÄRKE	±5%	
			RETTILINEITÀ STRAIGHTNESS OF SIDES. RECTITUDE DES BORDS RECHTECKIGKEIT DER ECKEN	±0.5%	
			ORTOGONALITÀ. RECTANGULARITY. ORTHOGONALITÉ. RECHTWINKLIGKEIT	±0.5%	
			PLANARITÀ SURFACE FLATNESS. PLANEITUDE EBENFLÄCHIGKEIT	±0.5%	
			95% DELLE PIASTRELLE ESENTI DA DIFETTI VISIBILI 95% OF TILES SHOW NO VISIBLE DEFECTS 95% DES CARREAUX SONT DÉPOURVUS DE DÉFAUTS VISIBLES 95% DER FLIESEN SIND FREI VON SICHTBAREN FEHLERN		
	ASSORBIMENTO D'ACQUA WATER ABSORPTION ABSORPTION D'EAU WASSERAUFNAHME	ISO 10545-3	≤ 0,5 %	CONFORME COMPLIANT CONFORME ERFÜLLT	
	RESISTENZA ALLA FLESSIONE BREAKING MODULUS RESISTANCE A LA FLEXION BIEGESTÄRKE	ISO 10545-4	≥ 35 N/mm ²	CONFORME COMPLIANT CONFORME ERFÜLLT	
	SFORZO DI ROTTURA MODULUS OF RUPTURE CHARGE DE RUPTURE BRUCHLAST	ISO 10545-4	≥ 7,5 mm = ≥ 1300 N < 7,5 mm = ≥ 700 N	CONFORME COMPLIANT CONFORME ERFÜLLT	
	RESISTENZA ALLA ABRASIONE PROFONDA DEEP ABRASION RESISTANCE RESISTANCE A L'ABRASION PROFONDE BESTÄNDIGKEIT GEGEN TIEFENVERSCHLEISS	ISO 10545-6	≤ 175 mm ³	CONFORME COMPLIANT CONFORME ERFÜLLT	
	COEFFICIENTE DI DILATAZIONE TERMICA LINEARE THERMAL EXPANSION COEFFICIENT COEFFICIENT DE DILATATION THERMIQUE LINEAIRE WARMEAUSSDEHNUNGSKOEFFIZIENT	ISO 10545-8	METODO DISPONIBILE AVAILABLE ON REQUEST METHODE DISPONIBLE VERFÜGBARES VERFAHREN	≤ 7x10 ⁻⁶ °C ⁻¹	
	RESISTENZA AGLI SBALZI TERMICI THERMAL SHOCK RESISTANCE RESISTANCE AUX ECARTS DE TEMPERATURE TEMPERATURWECHSELBESTÄNDIGKEIT	ISO 10545-9	METODO DISPONIBILE AVAILABLE ON REQUEST METHODE DISPONIBLE VERFÜGBARES VERFAHREN	RESISTENTI RESISTANT RÉSISTANTS WIDERSTANDSFAHIG	
	RESISTENZA AL GELO FROST RESISTANCE RESISTANCE AU GEL FROSTBESTÄNDIGKEIT	ISO 10545-12	RICHIESTA ALWAYS TESTED EXIGÉE NOTWENDIG	RESISTENTI RESISTANT RÉSISTANTS WIDERSTANDSFAHIG	
	PRODOTTI CHIMICI AD USO DOMESTICO ED ADDITIVI PER PISCINA HOUSEHOLD CHEMICALS AND SWIMMING POOL WATER CLEANSERS PRODUITS CHIMIQUES COURANTS ET ADDITIFS POUR PISCINE CHEM. PRODUKTE FÜR DEN HAUSHALTSGEBRAUCH UND ZUSATZ FÜR SCHWIMMBÄDER	ISO 10545-13	METODO DISPONIBILE AVAILABLE ON REQUEST METHODE DISPONIBLE VERFÜGBARES VERFAHREN	CONFORME COMPLIANT CONFORME ERFÜLLT	
	ACIDI ED ALCALI A BASSA CONCENTRAZIONE ACIDS AND LOW CONCENTRATION ALKALIS ACIDES ET ALCALI A FAIBLE CONCENTRATION SÄUREN UND ALKALI IN GERINGER KONZENTRATION		COME DICHIARATO DAL PRODUTTORE AS DECLARED BY THE MANUFACTURER COMME LE DÉCLARE LE PRODUCTEUR WIE VOM HERSTELLER ERKLÄRT	RESISTENTI RESISTANT RÉSISTANTS WIDERSTANDSFAHIG	
	ACIDI ED ALCALI AD ALTA CONCENTRAZIONE. ACIDS AND HIGH CONCENTRATION ALKALIS ACIDES ET ALCALI A FORTE CONCENTRATION. SÄUREN UND ALKALI IN HOHER KONZENTRATION		METODO DISPONIBILE. AVAILABLE ON REQUEST METHODE DISPONIBLE. VERFÜGBARES VERFAHREN	RESISTENTI. RESISTANT RÉSISTANTS. WIDERSTANDSFAHIG	
	RESISTENZA ALLE MACCHIE STAIN RESISTANCE RESISTANCE AUX TACHES FLECKBESTÄNDIGKEIT	ISO 10545-14	METODO DISPONIBILE AVAILABLE ON REQUEST METHODE DISPONIBLE VERFÜGBARES VERFAHREN	RESISTENTI RESISTANT RÉSISTANTS WIDERSTANDSFAHIG	
	STABILITÀ DEI COLORI ALLA LUCE COLOUR STABILITY TO LIGHT STABILITÉ DES COULEURS A LA LUMIÈRE LICHTECHTHEIT DER FARBEN	DIN 51094	METODO DISPONIBILE AVAILABLE ON REQUEST METHODE DISPONIBLE VERFÜGBARES VERFAHREN	CONFORME COMPLIANT CONFORME ERFÜLLT	
	COEFFICIENTE DI ATTRITO (SCIVOLOSITÀ) FRICTION COEFFICIENT (SLIPPERINESS) COEFFICIENT DE FROTTEMENT (GLISSANCE) REIBUNGSKOEFFIZIENT (GLÄTTE)	ENI6165 ANNEX B (DIN 51130)	DOVE RICHIESTO IF NEEDED SI DEMANDE NACH ANFORDERUNG	A RICHIESTA AVAILABLE ON REQUEST SUR DEMANDE AUF ANFRAGE	
		ENI6165 ANNEX A (DIN 51097)			
		D.M. 236/89			
		B.C.R.			
		ANSI A 326.3:2021			

Classificazione secondo UNI EN 14411 - ISO 13006 - G - Bla (E ≤ 0,5%) GL

Product in compliance with UNI EN 14411 - ISO 13006 - G - Bla (E ≤ 0,5%) GL

Classement selon UNI EN 14411 - ISO 13006 - G - Bla (E ≤ 0,5%) GL

Klassifizierung nach UNI EN 14411 - ISO 13006 - G - Bla (E ≤ 0,5%) GL

GRES PORCELLANATO

Porcelain tiles

Grès cérame

Feinsteinzeug

	CARATTERISTICA SPECIFICATION CARACTERISTIQUE EIGENSCHAFT	METODO DI PROVA TEST METHODS METHODE D'ESSAI TESTVERFAHREN	VALORE PRESCRITTO FIXED VALUE VALEUR PRESCRITE VORGESCHRIEBENER WERT		
	CARATTERISTICHE DIMENSIONALI DIMENSIONS AND SURFACE QUALITY DIMENSIONS DIMENSIONALE EIGENSCHAFTEN	ISO 10545-2	LUNGHEZZA E LARGHEZZA LENGTH AND WIDTH. LONGUEUR ET LARGEUR. LÄNGE UND BREITE	±0.6% or ±2mm	CONFORME COMPLIANT CONFORME ERFÜLLT
			SPESSORE THICKNESS. EPAISSEUR. STÄRKE	±5%	
			RETTILINEITÀ STRAIGHTNESS OF SIDES. RECTITUDE DES BORDS RECHTECKIGKEIT DER ECKEN	±0.5%	
			ORTOGONALITÀ. RECTANGULARITY. ORTHOGONALITÉ. RECHTWINKLIGKEIT	±0.5%	
			PLANARITÀ SURFACE FLATNESS. PLANEITUDE EBENFLÄCHIGKEIT	±0.5%	
			95% DELLE PIASTRELLE ESENTI DA DIFETTI VISIBILI 95% OF TILES SHOW NO VISIBLE DEFECTS 95% DES CARREAUX SONT DÉPOURVUS DE DÉFAUTS VISIBLES 95% DER FLIESEN SIND FREI VON SICHTBAREN FEHLERN		
	ASSORBIMENTO D'ACQUA WATER ABSORPTION ABSORPTION D'EAU WASSERAUFNAHME	ISO 10545-3	≤ 0,5 %	CONFORME COMPLIANT CONFORME ERFÜLLT	
	RESISTENZA ALLA FLESSIONE BREAKING MODULUS RESISTANCE A LA FLEXION BIEGESTÄRKE	ISO 10545-4	≥ 35 N/mm ²	CONFORME COMPLIANT CONFORME ERFÜLLT	
	SFORZO DI ROTTURA MODULUS OF RUPTURE CHARGE DE RUPTURE BRUCHLAST	ISO 10545-4	≥ 7,5 mm = ≥ 1300 N < 7,5 mm = ≥ 700 N	CONFORME COMPLIANT CONFORME ERFÜLLT	
	RESISTENZA ALLA ABRASIONE DELLA SUPERFICIE DI PIASTRELLE SMALTATE RESISTANCE TO SURFACE ABRASION OF GLAZED TILES RESISTANCE À L'ABRASION DE LA SURFACE DES CARREAUX ÉMAILLÉS WIDERSTAND GEGEN ABRIB DER OBERFLÄCHE DER GLASIERTEN FLIESEN	ISO 10545-7	CLASSI 0-5	SECONDO QUANTO DICHIARATO AS DECLARED SUIVANT LES DÉCLARATIONS GEMÄSS DEN ANGABEN	
	COEFFICIENTE DI DILATAZIONE TERMICA LINEARE THERMAL EXPANSION COEFFICIENT COEFFICIENT DE DILATATION THERMIQUE LINEAIRE WARMEAUSSDEHNUNGSKOEFFIZIENT	ISO 10545-8	METODO DISPONIBILE AVAILABLE ON REQUEST METHODE DISPONIBLE VERFÜGBARES VERFAHREN	≤ 7x10 ⁻⁶ °C ⁻¹	
	RESISTENZA AGLI SBALZI TERMICI THERMAL SHOCK RESISTANCE RESISTANCE AUX ECARTS DE TEMPERATURE TEMPERATURWECHSELBESTÄNDIGKEIT	ISO 10545-9	METODO DISPONIBILE AVAILABLE ON REQUEST METHODE DISPONIBLE VERFÜGBARES VERFAHREN	RESISTENTI RESISTANT RÉSISTANTS WIDERSTANDSFAHIG	
	RESISTENZA AL GELO FROST RESISTANCE RESISTANCE AU GEL FROSTBESTÄNDIGKEIT	ISO 10545-12	RICHIESTA ALWAYS TESTED EXIGÉE NOTWENDIG	RESISTENTI RESISTANT RÉSISTANTS WIDERSTANDSFAHIG	
	PRODOTTI CHIMICI AD USO DOMESTICO ED ADDITIVI PER PISCINA HOUSEHOLD CHEMICALS AND SWIMMING POOL WATER CLEANSERS PRODUITS CHIMIQUES COURANTS ET ADDITIFS POUR PISCINE CHEM. PRODUKTE FÜR DEN HAUSHALTSGEBRAUCH UND ZUSATZ FÜR SCHWIMMBÄDER	ISO 10545-13	METODO DISPONIBILE AVAILABLE ON REQUEST METHODE DISPONIBLE VERFÜGBARES VERFAHREN	CONFORME COMPLIANT CONFORME ERFÜLLT	
	ACIDI ED ALCALI A BASSA CONCENTRAZIONE ACIDS AND LOW CONCENTRATION ALKALIS ACIDES ET ALCALI A FAIBLE CONCENTRATION SÄUREN UND ALKALI IN GERINGER KONZENTRATION		COME DICHIARATO DAL PRODUTTORE AS DECLARED BY THE MANUFACTURER COMME LE DÉCLARE LE PRODUCTEUR WIE VOM HERSTELLER ERKLÄRT	RESISTENTI RESISTANT RÉSISTANTS WIDERSTANDSFAHIG	
	ACIDI ED ALCALI AD ALTA CONCENTRAZIONE. ACIDS AND HIGH CONCENTRATION ALKALIS ACIDES ET ALCALI A FORTE CONCENTRATION. SÄUREN UND ALKALI IN HOHER KONZENTRATION		METODO DISPONIBILE. AVAILABLE ON REQUEST METHODE DISPONIBLE. VERFÜGBARES VERFAHREN	RESISTENTI. RESISTANT RÉSISTANTS. WIDERSTANDSFAHIG	
	RESISTENZA ALLE MACCHIE STAIN RESISTANCE RESISTANCE AUX TACHES FLECKBESTÄNDIGKEIT	ISO 10545-14	METODO DISPONIBILE AVAILABLE ON REQUEST METHODE DISPONIBLE VERFÜGBARES VERFAHREN	RESISTENTI RESISTANT RÉSISTANTS WIDERSTANDSFAHIG	
	STABILITÀ DEI COLORI ALLA LUCE COLOUR STABILITY TO LIGHT STABILITÉ DES COULEURS A LA LUMIÈRE LICHTECHTHEIT DER FARBEN	DIN 51094	METODO DISPONIBILE AVAILABLE ON REQUEST METHODE DISPONIBLE VERFÜGBARES VERFAHREN	CONFORME COMPLIANT CONFORME ERFÜLLT	
	COEFFICIENTE DI ATTRITO (SCIVOLOSITÀ) FRICTION COEFFICIENT (SLIPPERINESS) COEFFICIENT DE FROTTEMENT (GLISSANCE) REIBUNGSKOEFFIZIENT (GLÄTTE)	ENI6165 ANNEX B (DIN 51130)	DOVE RICHIESTO IF NEEDED SI DEMANDE NACH ANFORDERUNG	A RICHIESTA AVAILABLE ON REQUEST SUR DEMANDE AUF ANFRAGE	
		ENI6165 ANNEX A (DIN 51097)			
		D.M. 236/89			
		B.C.R.			
		ANSI A 326.3:2021			

Caratteristiche tecniche

Technical features / Caracteristiques techniques / Technische eigenschaften

Classificazione secondo UNI EN 14411 - ISO 13006 B IIIa - GL -

Product in compliance with UNI EN 14411 - ISO 13006 B IIIa - GL -
 Classement selon UNI EN 14411 - ISO 13006 B IIIa - GL -
 Klassifizierung nach UNI EN 14411 - ISO 13006 B IIIa - GL -

PASTA BIANCA - RIVESTIMENTO

White body - wall tiles
 Pâte blanche - pour revêtement
 Weißscherbisig - Für wanderbelag

	CARATTERISTICA SPECIFICATION CARACTERISTIQUE EIGENSCHAFT	METODO DI PROVA TEST METHODS METHODE D'ESSAI TESTVERFAHREN	VALORE PRESCRITTO FIXED VALUE VALEUR PRESCRITE VORGESCHRIEBENER WERT	UNITÀ DI MISURA UNIT OF MEASUREMENT UNITÉ DE MESURE MASSEINHEIT	
	DIMENSIONE LATI DIMENSIONS - LENGHT AND WIDTH DIMENSIONS - LONGUEUR ET LARGEUR LÄNGE UND BREITE	UNI EN ISO 10545-2	± 0,5	%	
	RETTILINEITÀ DEI LATI SIDES' STRAIGHTNESS RECTITUDE DES CÔTES GERADLINIGKEIT DER KANTEN		± 0,3	%	
	ORTOGONALITÀ DEI LATI SIDES' RECTANGULARITY OCTOGONALITÉ DES CÔTES RECHTWINKLIGKEIT DER KANTEN		± 0,5	%	
	PLANARITÀ FLATNESS PLANEITUDE EBENFLÄCHIGKEIT		± 0,5	%	
	SPESSORE THICKNESS ÉPAISSEUR STÄRKE		± 10	%	
	ASSORBIMENTO D'ACQUA WATER ABSORPTION ABSORPTION D'EAU WASSERAUFNAHME	UNI EN ISO 10545-3	> 10	%	CONFORME . COMPLIANT CONFORME . ERFÜLLT
	SFORZO DI ROTTURA MODULUS OF RUPTURE CHARGE DE RUPTURE BRUCHLAST	UNI EN ISO 10545-4	≥ 600 SE SPESS ≥ 7,5 MM. ≥ 200 SE SPESS < 7,5 MM.	N	CONFORME . COMPLIANT CONFORME . ERFÜLLT
	RESISTENZA ALLA FLESSIONE BREAKING MODULUS RESISTANCE A LA FLEXION BIEGEFESTIGKEIT		≥ 15 SE SPESS < 7,5 mm. ≥ 12 SE SPESS ≥ 7,5 mm.	N/mm2	CONFORME . COMPLIANT CONFORME . ERFÜLLT
	COEFFICIENTE DI DILATAZIONE TERMICA LINEARE THERMAL EXPANSION COEFFICIENT COEFFICIENT DE DILATATION THERMIQUE LINEAIRE WARMEAUDEHNUNGSKOEFFIZIENT	UNI EN ISO 10545-8	METODO DISPONIBILE AVAILABLE ON REQUEST METHODE DISPONIBILE VERFÜGBARES VERFAHREN	*MK (-1)	7,00
	RESISTENZA AGLI SBALZI TERMICI THERMAL SHOCK RESISTANCE RESISTANCE AUX ECARTS DE TEMPERATURE. TEMPERATURWECHSELBESTÄNDIGKEIT	UNI EN ISO 10545-9	METODO DISPONIBILE AVAILABLE ON REQUEST METHODE DISPONIBILE VERFÜGBARES VERFAHREN		RESISTENTI . RESISTANT RÉSISTANTS . WIDERSTANDSFAHIG
	RESISTENZA AL CAVILLO CRAZING RESISTANT RÉSISTENCE AUX TRÉSSAILLURES HAARRISSE	UNI EN ISO 10545-11	RICHIESTA . ALWAYS TESTED EXIGEE . NOTWENDIG		RESISTENTI . RESISTANT RÉSISTANTS . WIDERSTANDSFAHIG
	RESISTENZA ALLE MACCHIE STAIN RESISTANCE RÉSISTANCE AUX TACHES FLECKBESTÄNDIGKEIT	UNI EN ISO 10545-14	3 MIN		4-5
	RESISTENZA ALL'ATTACCO CHIMICO CHEMICAL RESISTANCE RÉSISTENCE AUX PRODUITS CHIMIQUE BESTÄNDIGKEIT GEBIEN CHEMIKALIEN	UNI EN ISO 10545-13	GBMIN		CONFORME . COMPLIANT CONFORME . ERFÜLLT
	RESISTENZA AGLI ACIDI E ALLE BASI A BASSA CONCENTRAZIONE RESISTANT TO ACID AND LOW CONCENTRATION BASES RESISTANCE AUX ACIDES ET AUX BASES À FAIBLE CONCENTRATION WIDERSTANDSFÄHIGKEIT GEGENUBER NIEDRIG KONZENTRIERTEN SÄUREN UND LAUGEN		METODO DISPONIBILE AVAILABLE ON REQUEST METHODE DISPONIBILE VERFÜGBARES VERFAHREN		≥ GLB
	RESISTENZA ALL'ABRASSIONE RESISTANCE TO ABRASION RÉSISTENCE À L'ABRASION BESTÄNDIGKEIT GEGEN OBERFLÄCHENVERSCHLEISS	UNI EN ISO 10545-7	CLASSE 1-5 CLASS 1-5 CLASSE 1-5 KLASSE 1-5		2-5

Certificazioni di prodotto /

Product certification / Certification de produit / Produkt Zertifizierungen.

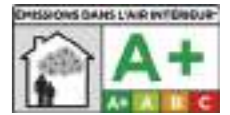

Tutte le piastrelle sono certificabili MOCA.
 All the tiles can be MOCA-certified.
 Toutes les carreaux sont certifiées MOCA.
 Alle Bodenfliesen sind nach MOCA
 zertifizierbar.



SMALL, UP



DOLOMITI, HIGH LINE, I QUARZI, KAURI
 LASCAUX, SPACE, STORM, SKYLINE



I QUARZI



Attestazione della percentuale di riciclato, Dichiarazione Ambientale di prodotto settoriale, UPEC, Marchio CCC, Marcatura CE, Certificazione VOC-COV, Conformità Bielorussia, Conformità Egitto ES 3168-2/2015

Certificate of percentage of recycled material, Industry-specific Environmental Product Declaration, UPEC, CCC mark, CE marking, VOC certification, Compliance for Byelorussia, Compliance for Egypt ES 3168-2/2015

Attestation du pourcentage de matériel recyclé, Déclaration environnementale de produit sectoriel, UPEC, Label CCC, Marquage CE, certification VOC-COV, conformité Biélorussie, conformité Égypte ES 3168-2/2015

Bescheinigung des Anteils von Recycling-Produkten, Umweltschutz-Erklärung der Produkte nach Bereichen, UPEC, CCC-Kennzeichnung, CE-Kennzeichnung, VOC-COV-Zertifizierung, Konformität für Weißrussland, Ägypten ES 3168-2/2015

Certificazioni Ambientali / Environmental Certifications

Italcer S.p.A. SB adotta e mantiene attivo un processo sistematico di verifica, misura e monitoraggio delle performance dei suoi processi ambientali, che assicura il rispetto dei requisiti cogenti, consente di riesaminare lo stato della gestione e permette di intervenire con le adeguate azioni correttive e preventive per superare le criticità individuate. L'adozione di un Sistema di Gestione Ambientale certificato conforme allo standard ISO 14001 ed al Regolamento EMAS, di un Sistema di Gestione per l'Energia e di altri standard ambientali costituiscono tappe significative di un percorso di crescita attraverso il quale vogliamo dare il nostro contributo ad uno Sviluppo Sostenibile e ad un dialogo trasparente e costruttivo con le Parti Interessate.

Italcer S.p.A. SB applies and updates a systematic performance check, measurement and monitoring process for its environmental processes, which ensures respect for binding requirements, enables it to review the management status and apply the suitable corrective and preventive actions to overcome any critical points identified. The adoption of a certified Environmental Management System compliant with the ISO 14001 standard and the EMAS Regulation, an Energy Management System and other environmental standards constitute significant steps on a path of growth, whereby we strive to provide our contribution to Sustainable Development and transparent and constructive dialogue with the Relevant Parties.

CERTIFICAZIONE - CERTIFICATION CERTIFICATION - BESCHEINIGUNG	NUMERO - NUMBER NOMBRE - ZAHL	DESCRIZIONE / DESCRIPTION / DESCRIPTION / BESCHREIBUNG
	DT 55 P1059 del 21/10/2008	<p>Italcer S.p.A. SB è associata al Green Building Council Italia, organismo indipendente che ha come obiettivo la diffusione di una cultura dell'edilizia sostenibile ed in particolare la promozione del sistema di certificazioni LEED (Leadership in Energy and Environmental Design). I prodotti di LA FABBRICA AVA contengono percentuali di materia prima riciclata superiori anche al 50%, consentendo ai loro utilizzatori di accedere all'ottenimento di crediti LEED. Per saperne di più visita il sito www.gbctalia.org.</p> <p>Italcer S.p.A. SB is a member of Green Building Council Italy</p>
	EMAS Eco-Management and Audit Scheme IT 000907 del 16/5/2008	<p>Eco-Management and Audit Scheme (EMAS) è uno strumento volontario creato dalla Comunità Europea al quale possono aderire volontariamente le aziende per valutare e migliorare le proprie prestazioni ambientali, fornendo al pubblico e ad altri soggetti interessati informazioni sulla propria gestione ambientale. Scopo prioritario dell'EMAS è contribuire alla realizzazione di uno sviluppo economico sostenibile, ponendo in rilievo il ruolo e le responsabilità delle imprese e promuovendone il miglioramento continuo.</p> <p>The Eco-Management and Audit Scheme (EMAS) is a voluntary initiative created by the EU, which companies can participate in voluntarily, to assess and improve their environmental performance, providing the public and other relevant parties with information on their environmental management practices. The main priority of EMAS is to contribute to the implementation of sustainable economic development, highlighting the roles and responsibilities of companies and promoting their continuous improvement.</p>
	UNI CEI EN ISO 50001:2018 Sistema di gestione per l'energia Certificato n° 26196 18/10/2018	<p>L'obiettivo della certificazione ISO 50001 è quello di consentire che un'organizzazione persegua, con un approccio sistematico, il miglioramento continuo delle proprie prestazioni energetiche. Per Italcer S.p.A. SB consiste nel naturale completamento del sistema di gestione ambientale, con importanti ricadute anche sul piano dell'efficienza economica.</p> <p>The goal of the ISO 50001 certification is to enable an organisation to systematically pursue the continuous improvement of its energy performance. For Italcer S.p.A. SB, this is the natural complement to the environmental management system, with important impacts in terms of economic efficiency as well.</p>
	UNI EN ISO 14001:2015 Sistema di gestione ambientale Certificato n° 12762 24/01/2008	<p>La certificazione ISO 14001 dimostra che l'azienda ha un sistema di gestione adeguato a tenere sotto controllo gli impatti ambientali delle proprie attività, e ne ricerca sistematicamente il miglioramento.</p> <p>The ISO 14001 certification demonstrates that the company has a management system suited to keeping the environmental impact of its activities under control, and systematically strives for improvement.</p>
	EPD EPD - COI - 20160202 ICG1 - IT Confindustria Ceramica	<p>EPD è una dichiarazione ambientale di prodotto certificata e verificata da un soggetto indipendente che fornisce un'informazione chiara e confrontabile relativamente alle performance ambientali lungo tutto il suo ciclo di vita, conformemente a quanto stabilito dallo standard ISO 14025. L'industria ceramica italiana si è dotata di questo strumento dal 2015.</p> <p>EPD is an independently certified and verified environmental product declaration which provides clear and comparable information relating to environmental performance throughout its entire lifecycle, in compliance with the ISO 14025 standard. The Italian ceramics industry has adopted this instrument since 2015.</p>
	GOOD PHYTOSANITARY PRACTICES	<p>I marchi commerciali di Italcer S.p.A. SB sono inseriti nel Registro delle Aziende Qualificate per il rispetto delle Linee Guida del programma "Good Phytosanitary Practices (GPP)", uno standard finalizzato al miglioramento delle pratiche fitosanitarie per procedure di spedizione di container verso gli Stati Uniti. Una certificazione strategica per il miglioramento dei rapporti con gli operatori di uno dei mercati più importanti al mondo.</p> <p>Italcer S.p.A. SB's trademarks are included in the Register of Qualified Companies for their respect for the Guidelines of the "Good Phytosanitary Practices (GPP)" programme, a standard intended to improve phytosanitary practices for container shipping to the United States. A strategic certification for the improvement of relationships with operators in one of the most important markets in the world.</p>

Salute e Sicurezza sul Lavoro / Occupational health and safety

CERTIFICAZIONE - CERTIFICATION CERTIFICATION - BESCHEINIGUNG	NUMERO - NUMBER NOMBRE - ZAHL	DESCRIZIONE / DESCRIPTION / DESCRIPTION / BESCHREIBUNG
	UNI ISO 45001:2018 Salute e Sicurezza sul lavoro Certificato n° 27008 04/02/2020	<p>Lo standard ISO 45001 è la prima norma internazionale a definire gli standard minimi di buona pratica per la protezione dei lavoratori in tutto il mondo. Uno strumento di tutela del patrimonio di salute dei lavoratori, un mezzo per instaurare un rapporto proficuo e trasparente con Organizzazioni Sindacali ed Enti di Controllo, ma soprattutto l'evidenza che si può e si deve fare business nel pieno rispetto dei diritti della Persona.</p> <p>ISO 45001 is the first international standard to define the minimum best practices for worker protection all over the world. A tool to protect worker health, a means to establish a profitable and transparent relationship with trade unions and supervisory bodies, but especially proof that it is possible and indeed necessary to do business with full respect for people's rights.</p>



ITALCER - WINNER OF THE 2022 SUSTAINABILITY AWARD

Qualità e Sostenibilità / Quality and Sustainability

Italcer S.p.a. SB è un'azienda leader nella produzione di piastrelle ceramiche, che si caratterizza non solo per la qualità dei prodotti, ma anche per la sostenibilità sociale ed ambientale della sua gestione. Per noi è impensabile parlare di qualità, successo, miglioramento e sviluppo senza estendere questi concetti ai temi della protezione della Risorsa Umana e della tutela dell'Ambiente, che rappresentano per il Gruppo Italcer la cifra del suo fare impresa e fattore strategico per assicurare successo durevole e capacità di competere a livello mondiale. Inoltre nel 2022 il Gruppo Italcer è stato riconosciuto al vertice della classifica, stilata dal Team Credit Suisse, Kon Group e Forbes, tra le 100 eccellenze italiane premiate al Sustainability Award 2022.

Italcer S.p.A. SB is a leader in the production of ceramic tiles, which is known not only for product quality, but also for its socially and environmentally sustainable management. For us, it is unthinkable to speak of quality, success, improvement and development without extending these concepts to the protection of Human Resources and the Environment, which for Italcer Group represent its way of doing business and a strategic factor to ensure lasting success and the capacity to compete at global level. Moreover, in 2022 Italcer Group was recognised as one of the top 100 Italian companies to receive the Sustainability Award 2022, in the ratings drawn up by Credit Suisse, Kon Group and Forbes.

CERTIFICAZIONE - CERTIFICATION CERTIFICATION - BESCHEINIGUNG	NUMERO - NUMBER NOMBRE - ZAHL	DESCRIZIONE / DESCRIPTION / DESCRIPTION / BESCHREIBUNG
	UNI EN ISO 9001:2015 Qualità Certificato n° 27007 30/05/2019	<p>Il Sistema di gestione per la qualità ISO 9001 è il "contenitore" che assicura il rispetto di tutti i requisiti cogenti e volontari sottoscritti. Fornisce alla direzione una base dati completa, aggiornata e affidabile che consente di prendere decisioni consapevoli e tempestive, e promuove il miglioramento sinergico e coerente in tutti i processi gestiti dai diversi standard.</p> <p>The ISO 9001 quality management system is the "container" which ensures respect for all requirements, both binding and voluntary. It provides the management with a complete, updated and reliable database which makes it possible to take knowledgeable and prompt decisions, and promotes synergistic and consistent improvement across all processes managed by the various standards.</p>

Consigli per la corretta pulizia e manutenzione del prodotto

Important product cleaning and maintenance / Conseils pour le nettoyage et l’entretien corrects du produit.

Hinweise und Empfehlungen für die richtige Reinigung und Pflege des Produktes.

Pulizia del pavimento

Pulizia del pavimento

Eeguire una precisa e corretta pulizia del prodotto ceramico è di fondamentale importanza per mantenerne nel tempo l'originaria lucentezza e bellezza. Si raccomanda pertanto di seguire con attenzione le indicazioni seguenti.

A) PULIZIA "DOPO-POSA" IN CANTIERE

Il lavaggio iniziale delle piastrelle nel "dopo-posa" in cantiere è una fase di fondamentale importanza.

È infatti in questo momento che è possibile rimuovere agevolmente dalle piastrelle tutti i residui dei materiali usati per la posa e/o della stuccatura delle fughe della piastrella stessa. Si tratta di residui di varia natura che, se lasciati "asciugare e/o seccare" sulle piastrelle, soprattutto in quelle caratterizzate da una superficie strutturata più o meno accentuata potrebbero diventare difficili da rimuovere successivamente. Si raccomanda sempre la massima attenzione alla scelta dell'agente pulente per non alterare irrimediabilmente il grado di lucentezza e brillantezza della piastrella posata.

Pulizia del pavimento stuccato con "Stucchi cementizi a base d'acqua"

Come già accennato, con il lavaggio "dopo-posa" si rimuovono i residui di cemento, stucchi cementizi, salnitri, colle ed eventuali residui superficiali del materiale di varia natura. In questa fase il pavimento deve essere lavato con detergenti a base di acidi tamponati entro almeno 3-4 giorni dopo la posa e mai oltre i 10 giorni. NB: Per i prodotti caratterizzati da superfici strutturate e/o anticivolo si raccomanda, viste le asperità della struttura, di sporcare il meno possibile la superficie della piastrella durante le fasi della posa e di pulire bene subito dopo la stuccatura gli eccessi di materiali utilizzati con una spugna bagnata in acqua pulita. Si raccomanda altresì di eseguire la procedura sotto-descritta il prima possibile e comunque prima dei su citati 3-4 giorni massimi dal "dopo-posa".

Detergenti consigliati:

Keranet.....Mapei
DeterdekFila
DeltaplusKerakoll
Cement RemoverFaber Chimica
Deterpav Professional.....Madras
Gres Cleaner Extreme SpecialPriscopio Soluzioni
Solvacid.....Geal

Procedere come segue:

- Preparare il detergente come indicato in etichetta (si consiglia di effettuare prove preliminari su piastrelle non posate per verificare l'inalterabilità della superficie della piastrella).
- Bagnare preventivamente il pavimento con acqua pulita.
- Stendere la soluzione sulle piastrelle lasciando che agisca per qualche minuto.
- Passare la monospazzola utilizzando dischi appropriati (verdi per le superfici strutturate e rosso per le non strutturate) o una paglietta (verde per le superfici strutturate e rossa/marrone per le non strutturate) strofinando energicamente la superficie delle piastrelle.
- Risciacquare abbondantemente con acqua pulita aspirando il liquido.

Pulizia del pavimento stuccato con "Stucchi epossidici"

Nel caso di utilizzo di stucchi epossidici, considerato che essi induriscono rapidamente in pochi minuti, il lavaggio "dopo-posa" deve essere eseguito con detergenti alcalini il più rapidamente possibile attenendosi scrupolosamente alle indicazioni e procedure d'utilizzo indicati in etichetta.

Detergenti alcalini consigliati:

Kerapoxy Cleaner.....Mapei
PS/87Fila
Epoxy RemoverLaticrete
Keragel Eco.....Kerakoll
Wax RemoverFaber Chimica
Epoxy.Det.....Technokolla
Epoxy Cleaner Extreme.....Periscopio Soluzioni
Eposolu.....Geal

Procedere come segue:

- Preparare il detergente come indicato in etichetta (si consiglia di effettuare prove preliminari su piastrelle non posate per verificare l'inalterabilità della superficie della piastrella).
- Bagnare preventivamente il pavimento con acqua pulita.
- Stendere la soluzione sulle piastrelle lasciando che agisca per qualche minuto
- Passare la monospazzola utilizzando dischi appropriati (verdi per le superfici strutturate e rosso per le non strutturate) o una paglietta (verde per le superfici strutturate e rossa/marrone per le non strutturate) strofinando energicamente la superficie delle piastrelle.
- Risciacquare abbondantemente con acqua pulita aspirando il liquido

B) PULIZIA QUOTIDIANA

La pulizia ordinaria può essere fatta con l'ausilio di normali detergenti neutri adatti alla pulizia delle superfici ceramiche (es. Aquasol food), eventualmente diluendoli in acqua calda per aumentarne l'efficacia, attenendosi alle istruzioni in etichetta del produttore.

Pulizia del pavimento

Pulizia del pavimento

Pulizia del pavimento

Pulizia del pavimento

Pulizia del pavimento

Pulizia del pavimento

Pulizia del pavimento

Pulizia del pavimento

Pulizia del pavimento

Pulizia del pavimento

Pulizia del pavimento

Pulizia del pavimento

Pulizia del pavimento

Pulizia del pavimento

Pulizia del pavimento

Pulizia del pavimento

Pulizia del pavimento

Pulizia del pavimento

Pulizia del pavimento

Pulizia del pavimento

Pulizia del pavimento

Pulizia del pavimento

Pulizia del pavimento

Pulizia del pavimento

Pulizia del pavimento

Pulizia del pavimento

Pulizia del pavimento

Pulizia del pavimento

Pulizia del pavimento

Pulizia del pavimento

Pulizia del pavimento

Pulizia del pavimento

Pulizia del pavimento

Pulizia del pavimento

Pulizia del pavimento

Pulizia del pavimento

Pulizia del pavimento

Pulizia del pavimento

Pulizia del pavimento

Pulizia del pavimento

Pulizia del pavimento

Pulizia del pavimento

Pulizia del pavimento

Pulizia del pavimento

Pulizia del pavimento

Pulizia del pavimento

Pulizia del pavimento

Pulizia del pavimento

Pulizia del pavimento

Pulizia del pavimento

Pulizia del pavimento

Pulizia del pavimento

Pulizia del pavimento

Pulizia del pavimento

Pulizia del pavimento

Pulizia del pavimento

Pulizia del pavimento

Pulizia del pavimento

Pulizia del pavimento

Pulizia del pavimento

Pulizia del pavimento

Pulizia del pavimento

Pulizia del pavimento

Pulizia del pavimento

Pulizia del pavimento

Pulizia del pavimento

Pulizia del pavimento

Pulizia del pavimento

Pulizia del pavimento

Pulizia del pavimento

Pulizia del pavimento

Pulizia del pavimento

Pulizia del pavimento

Pulizia del pavimento

Pulizia del pavimento

Pulizia del pavimento

Pulizia del pavimento

Pulizia del pavimento

Pulizia del pavimento

Pulizia del pavimento

Pulizia del pavimento

Pulizia del pavimento

Pulizia del pavimento

Pulizia del pavimento

Pulizia del pavimento

Pulizia del pavimento

Pulizia del pavimento

Pulizia del pavimento

Pulizia del pavimento

Pulizia del pavimento

Pulizia del pavimento

Pulizia del pavimento

Pulizia del pavimento

Pulizia del pavimento

Pulizia del pavimento

Pulizia del pavimento

Pulizia del pavimento

Pulizia del pavimento

Pulizia del pavimento

Pulizia del pavimento

Pulizia del pavimento

Pulizia del pavimento

Pulizia del pavimento

Pulizia del pavimento

Pulizia del pavimento

Pulizia del pavimento

Pulizia del pavimento

Pulizia del pavimento

Pulizia del pavimento

Pulizia del pavimento

Pulizia del pavimento

Pulizia del pavimento

Pulizia del pavimento

Pulizia del pavimento

Pulizia del pavimento

Pulizia del pavimento

Pulizia del pavimento

Pulizia del pavimento

Pulizia del pavimento

Pulizia del pavimento

Pulizia del pavimento

Pulizia del pavimento

Pulizia del pavimento

Pulizia del pavimento

Pulizia del pavimento

Pulizia del pavimento

Pulizia del pavimento

Pulizia del pavimento

Pulizia del pavimento

Pulizia del pavimento

Pulizia del pavimento

Pulizia del pavimento

Pulizia del pavimento

Pulizia del pavimento

Pulizia del pavimento

Pulizia del pavimento

Pulizia del pavimento

Pulizia del pavimento

Pulizia del pavimento

Pulizia del pavimento

Pulizia del pavimento

Pulizia del pavimento

Pulizia del pavimento

Pulizia del pavimento

Pulizia del pavimento

Pulizia del pavimento

Pulizia del pavimento

Pulizia del pavimento

Pulizia del pavimento

Pulizia del pavimento

Pulizia del pavimento

Pulizia del pavimento

Pulizia del pavimento

Pulizia del pavimento

Pulizia del pavimento

Pulizia del pavimento

Pulizia del pavimento

Pulizia del pavimento

Pulizia del pavimento

Pulizia del pavimento

Pulizia del pavimento

Pulizia del pavimento

Pulizia del pavimento

Pulizia del pavimento

Pulizia del pavimento

Pulizia del pavimento

Pulizia del pavimento

Pulizia del pavimento

Pulizia del pavimento

Pulizia del pavimento

Pulizia del pavimento

Pulizia del pavimento

Pulizia del pavimento

Pulizia del pavimento

Pulizia del pavimento

Pulizia del pavimento

Pulizia del pavimento

Pulizia del pavimento

Pulizia del pavimento

Pulizia del pavimento

Pulizia del pavimento

Pulizia del pavimento

Pulizia del pavimento

Pulizia del pavimento

Pulizia del pavimento

Pulizia del pavimento

Pulizia del pavimento

Pulizia del pavimento

Pulizia del pavimento

Pulizia del pavimento

Pulizia del pavimento

Pulizia del pavimento

Pulizia del pavimento

Pulizia del pavimento

Pulizia del pavimento

Pulizia del pavimento

Pulizia del pavimento

Pulizia del pavimento

Pulizia del pavimento

Pulizia del pavimento

Pulizia del pavimento

Pulizia del pavimento

Pulizia del pavimento

Pulizia del pavimento

Pulizia del pavimento

Pulizia del pavimento

Pulizia del pavimento

Pulizia del pavimento

Pulizia del pavimento

Pulizia del pavimento

Pulizia del pavimento

Pulizia del pavimento

Pulizia del pavimento

Pulizia del pavimento

Pulizia del pavimento

Pulizia del pavimento

Pulizia del pavimento

Pulizia del pavimento

Pulizia del pavimento

Pulizia del pavimento

Pulizia del pavimento

Pulizia del pavimento

Pulizia del pavimento

Pulizia del pavimento

Pulizia del pavimento

Pulizia del pavimento

Pulizia del pavimento

Pulizia del pavimento

Pulizia del pavimento

Pulizia del pavimento

Pulizia del pavimento

Pulizia del pavimento

Pulizia del pavimento

Pulizia del pavimento

Pulizia del pavimento

Pulizia del pavimento

Pulizia del pavimento

Pulizia del pavimento

Pulizia del pavimento

Pulizia del pavimento

Pulizia del pavimento

Pulizia del pavimento

Pulizia del pavimento

Pulizia del pavimento

Pulizia del pavimento

Pulizia del pavimento

Pulizia del pavimento

Pulizia del pavimento

Pulizia del pavimento

Pulizia del pavimento

Pulizia del pavimento

Pulizia del pavimento

Pulizia del pavimento

Pulizia del pavimento

Pulizia del pavimento

Pulizia del pavimento

Pulizia del pavimento

Pulizia del pavimento

Pulizia del pavimento

Pulizia del pavimento

Pulizia del pavimento

Pulizia del pavimento

Pulizia del pavimento

Pulizia del pavimento

Pulizia del pavimento

Pulizia del pavimento

Pulizia del pavimento

Pulizia del pavimento

Pulizia del pavimento

Pulizia del pavimento

Pulizia del pavimento

Pulizia del pavimento

Pulizia del pavimento

Pulizia del pavimento

Pulizia del pavimento

Pulizia del pavimento

Pulizia del pavimento

Pulizia del pavimento

Condizioni generali di vendita /

General sales conditions / Conditions générales de vente / Allgemeine Geschäftsbedingungen

Italcer S.p.A. SB si riserva il diritto di modificare in qualunque momento le informazioni e le caratteristiche tecniche contenute nel presente catalogo ("Catalogo") e nel sito web (incluso tutti i documenti e cataloghi scaricabili via internet), che non sono da ritenersi legalmente vincolanti. Pesi, colori e misure possono subire variazioni tipiche del particolare processo di produzione del materiale ceramico. I colori e le caratteristiche estetiche dei prodotti sono quanto più possibile vicini a quelli reali, nei limiti consentiti dai processi di riproduzione virtuale.

Italcer S.p.A. SB considera le informazioni e le specifiche tecniche di cui al presente Catalogo corrette e precise; tuttavia non esclude la presenza di errori materiali ed invita i compratori ("Compratori") a verificare le informazioni e le specifiche tecniche con gli agenti / commerciali di riferimento. ©2020 Italcer S.p.A. SB Tutti i diritti sono riservati. Ogni riproduzione totale *e/o* parziale dei contenuti del presente Catalogo, sia di testo che di immagine, è vietata e sarà perseguita nei termini di legge.

1. PRODOTTO E GARANZIA

- Le elevate temperature di cottura del gres ceramico, possono provocare differenze di tono e di calibro. Sono perciò ammesse ed accettate dal Compratore delle differenze nelle dimensioni indicate, che però non superino i limiti di tolleranza prevista dalle norme UNI-EN-ISO 14411.
- Italcer S.p.A. SB garantisce i prodotti come conformi alle norme UNI-EN-ISO 14411 attualmente in vigore. La garanzia è limitata esclusivamente ai materiali di 1^ scelta. I materiali di 2^ e di 3^ scelta e le partite occasionali si intendono venduti come "visti e piaciuti, non contestabili".
- Le colorazioni dei materiali presentati in campionature sono da considerarsi puramente indicative. Eventuali variazioni di colore o di tonalità sono giustificate dalla natura stessa del materiale, dalle caratteristiche dei cicli di produzione e dalle materie prime impiegate. Si consiglia pertanto di miscelare il materiale, prelevandolo da diverse scatole, e di posare il materiale con una fuga distanziatrice.
- Decorì e pezzi speciali sono forniti in tonalità differenziate dal fondo.
- Italcer S.p.A. SB risponde solo ed esclusivamente della levigatura e della lucidatura effettuata nei propri stabilimenti.
- La garanzia comprende unicamente la sostituzione del materiale non posato riscontrato diftoso con esclusione di ogni ulteriore e diverse pretese.

2. ORDINI

- Ogni ordine trasmesso a Italcer S.p.A. SB dal Compratore, dagli agenti rappresentanti, od incaricati è da intendersi accettato sempre salvo approvazione della direzione di Italcer S.p.A. SB stessa.
- Tutte le ordinazioni, anche verbali, salvo accordi contrari scritti, si intendono sempre accettate da Italcer S.p.A. SB alle presenti condizioni generali, senza bisogno di richiamarle. In assenza di precise eccezioni scritte, si intende che il Compratore accetta integralmente le condizioni particolari e generali di vendita.

3. PREZZI

- I prezzi si intendono per merce resa franco stabilimento di produzione, IVA esclusa.
- Palette tipo EURO saranno addebitate al costo di euro 10,00/cad., nel caso di mancato scambio al momento del carico.

4. CONSEGNA

- I termini di consegna concordati con Italcer S.p.A. SB sono da intendersi puramente indicativi. Qualora si verifichino cause di forza maggiore, Italcer S.p.A. SB può recedere in parte o in toto dal contratto di vendita.
- I ritardi nella consegna non danno mai, al Compratore, il diritto di annullare il contratto, né di pretendere il risarcimento di eventuali danni diretti o indiretti.
- La merce viaggia sempre e comunque a rischio e pericolo del compratore. La merce si intende acquistata dal Compratore franco stabilimento di produzione, anche quando il prezzo fosse franco destino. Ogni responsabilità di Italcer S.p.A. SB cessa a carico compiuto, e non si risponde di eventuali rotture, manomissioni ed ammanchi.
- Quando le merci pronte per la spedizione rimangono, per richiesta del Compratore, presso gli stabilimenti di Italcer S.p.A. SB, la fattura viene emessa come se la spedizione fosse avvenuta ed i materiali vengono tenuti in magazzino a rischio, pericolo e spese del Compratore.

5. PAGAMENTO

- I pagamenti devono essere effettuati direttamente a Italcer S.p.A. SB nella sede di Rubiera (RE). La merce resta di proprietà di Italcer S.p.A. SB sino al momento del completo pagamento del prezzo concordato.
- Nel caso di ritardo nel pagamento totale ed anche parziale di una fattura, Italcer S.p.A. SB salvi tutti gli altri suoi diritti, avrà facoltà di sospendere le ulteriori consegne, anche se queste fossero dovute in dipendenza di altri contratti, di spiccare tratte per l'ammontare delle fatture scadute, ed anche di pretendere l'immediato e intero pagamento di tutto il materiale ordinato, o di averlo in altro modo garantito.
- In caso di ritardato pagamento verranno addebitati al Compratore interessi e oneri bancari ai tassi correnti del periodo di mora. Per tutto quanto non previsto nelle clause suindicate, si rimanda alla legge italiana ed agli usi vigenti.

6. RECLAMI

- Non si accettano reclami per i materiali già posati in opera. Reclami per vizi e difetti del materiale devono essere denunciati e comunicati nei termini previsti dalla legge. In ogni caso di accettazione del reclamo il Compratore dovrà restituire il materiale oggetto di contestazione che verrà sostituito da Italcer S.p.A. SB con fornitura equivalente. Tale sostituzione annulla il diritto del Compratore di chiedere la risoluzione del contratto o la riduzione del prezzo o il risarcimento di eventuali danni.
- Qualsiasi reclamo o contestazione non implica la sospensione ed il rifiuto al pagamento delle fatture. Il pagamento dovrà effettuarsi regolarmente ed integralmente nei termini convenuti.
- Non si accettano resi di merce se non autorizzati per iscritto da Italcer S.p.A. SB

7. FORO COMPETENTE

Per qualsiasi controversia il Foro competente è quello di Reggio Emilia (Italia). Tuttavia Italcer S.p.A. SB si riserva il diritto di agire presso il foro competente della sede del Compratore per azioni volte al recupero del credito. In tal caso troverà applicazione la legge locale.

Italcer S.p.A. SB reserves the right to change the information and technical specifications contained in this catalogue ("Catalogue") and on the website at any time (including all downloadable documents and catalogues) which are not considered legally binding. Weights, colours and measurements may vary due to the ceramic production process. The colours and aesthetic characteristics of products are as near as possible to actual colours and characteristics, within the limits of the virtual reproduction process. Italcer S.p.A. SB deems the information and technical specifications contained in this Catalogue to be correct and accurate; notwithstanding the presence of material errors is not excluded and the purchasers ("Purchasers") are invited to verify the information and technical specifications with their agents and area managers.©2020 Italcer S.p.A. SB All rights reserved. Any reproduction, whether total or partial, of the content of this Catalogue, whether text or image, is forbidden and will be prosecuted under the law.

1. PRODUCT AND WARRANTY

- The high temperatures used to fire ceramic stoneware can cause differences in shade and work size. Variations in the dimensions indicated shall therefore be accepted by the Purchaser, provided they are within the limits set by the UNI-EN-ISO 14411 standards.
- Italcer S.p.A. SB guarantees that products are compliant with current UNI-EN-ISO 14411 standards. This warranty applies to best-quality materials only; second- and third-class materials and one-off batches shall be sold "as seen and accepted" and may not be the object of claims.
- The colouring of the sample materials presented is to be considered merely indicative. Any variations in colour or shade are due to the particular nature of the material, the characteristics of the production cycle and the raw materials used. It is therefore advisable to mix the tiles by taking them from different boxes, and separate them with a joint when laying.
- Decorations and special trims are supplied in a different shade from the base tiles.
- Italcer S.p.A. SB shall be held responsible only for the smoothing and polishing processes carried out in its own factories.
- The warranty covers only the replacement of material found to be faulty, before laying. No other claims will be taken into consideration.

2. ORDERS

- All orders transmitted to Italcer S.p.A. SB by the Purchaser, by the sales agents or similar shall be deemed to have been accepted, subject to approval on the part of the management of Italcer S.p.A. SB
- All orders, including verbal orders, provided there are no written agreements to the contrary, shall be presumed to have been accepted by Italcer S.p.A. SB under the general sales conditions herein, without the need to expressly make reference to such conditions. Provided there are no precise written agreements to the contrary, the Purchaser is presumed to have accepted the general and specific sales conditions in full.

3. PRICES

- Prices are quoted EXW, exclusive of VAT.
- EURO type pallets will be charged at a cost of €10.00 each, in the event that the purchaser fails to provide their own for loading.

4. DELIVERY

- The delivery terms arranged with Italcer S.p.A. SB are to be considered merely indicative. In the event of force majeure, Italcer S.p.A. SB may terminate the sales contract, either completely or partially.
- Delays in delivery do not entitle the Purchaser to terminate the contract, or to claim for any direct or indirect damages deriving from delay.
- Goods travel at the risk and responsibility of the Purchaser at all times. Goods are understood to be bought by the Purchaser EXW, even if the price is carriage paid. Italcer S.p.A. SB's responsibility ends when the goods have been loaded, and Italcer S.p.A. SB may not be held responsible for any breakages, tampering or pilfering.
- When goods ready for delivery remain at Italcer S.p.A. SB 's premises at the request of the Purchaser, the invoice shall be issued as if delivery had already taken place, and the materials shall be held in the warehouse at the risk, responsibility and expense of the Purchaser.

5. PAYMENT

- Payments must be made directly to Italcer S.p.A. SB at its headquarters in Rubiera (Reggio Emilia). The goods shall remain the property of Italcer S.p.A. SB until the price agreed upon has been paid in full.
- In the event of a delay in payment of an invoice or part thereof, Italcer S.p.A. SB, all other rights reserved, shall be entitled to: place any further deliveries on hold, even in the event that such deliveries are due depending on other contracts; to draw a bill of exchange for the amount of the invoices overdue, and to demand full, immediate payment for all the material ordered, or to have such payment guaranteed by alternative means.
- In the event of delays in payment, interests and bank charges will be charged to the Purchaser at the rates applicable for the period corresponding to the delay. For all and any matters not expressly provided for in the clauses above, the Italian laws and current commercial practice shall apply.

6. CLAIMS

- Claims will not be accepted for materials that have already been laid. Claims for faults and defects must be reported within the terms provided for by law. For all claims accepted, the Purchaser must return the material concerned, which will be replaced by Italcer S.p.A. SB with an equivalent supply. Where such equivalent materials have been supplied, the Purchaser is not entitled to request the termination of the contract, nor the reduction in price or the compensation of damages of any kind.
- Any claims made do not entitle the Purchaser to suspend or refuse payment of the invoices. Payments due must be regularly made in full and in accordance with the terms agreed.
- Returns will not be accepted without the written authorization of the manufacturer.

7. COMPETENT COURT

For any disputes that may arise, the competent court is that of Reggio Emilia (Italy). As an exception to the above, Italcer S.p.A. SB reserves the right, for disputes related to credit recovery, to bring action before the competent court of the place where the Purchaser has its registered seat; in such case the Laws of such local court shall apply.

Italcer S.p.A. SB se réserve la faculté de modifier à tout moment les informations et les caractéristiques techniques figurant sur le catalogue (« Catalogue ») et le site Internet (y compris les documents et catalogues téléchargeables via Internet), ce qui également n'engage pas Italcer S.p.A. SB Poids, couleurs et dimensions peuvent subir des variations au processus de production propres du matériel céramique. Les couleurs et les caractéristiques esthétiques des produits sont les plus proches possibles des couleurs et des caractéristiques réelles, dans les limites des moyens de reproduction virtuelle. Italcer S.p.A. SB considère les informations et les caractéristiques techniques figurant sur le Catalogue exactes et précises ; cependant Italcer S.p.A. SB n'exclut pas la présence d'erreurs matérielles et demande aux acheteurs (« Acheteurs ») de vérifier les informations et les caractéristiques techniques avec les commerciaux et/ou représentants. ©2020 Italcer S.p.A. SB Tous les droits sont réservés. Toute reproduction totale ou partielle des contenus du présent Catalogue, textes et images, est interdite et sera poursuivie en termes de droit.

1. PRODUIT ET GARANTIE

- Les hautes températures de cuisson du grès cérame peuvent occasionner des différences de tonalité et de calibre. L'Acheteur déclare donc admettre et accepter les écarts de dimensions mentionnés qui, en tout état de cause, devront respecter les limites de tolérance posées par les normes UNI-EN-ISO 14411.
- Italcer S.p.A. SB s'engage à fournir des produits conformes aux normes UNI-EN-ISO 14411 en vigueur. La garantie ne couvre que les matériaux de premier choix. Les matériaux de deuxième et troisième choix et les occasions sont vendus « en l'état », sans possibilité de contestations.
- Les couleurs des échantillons fournis ne sont données qu'à titre purement indicatif. Toute variation de nuance ou tonalité est justifiée par la nature du matériau, par les caractéristiques des cycles de production et par les matières premières employées. Par conséquent, il est recommandé de mélanger les carreaux des différentes boîtes et de les poser avec un joint d'écartement.
- Les décors et les pièces spéciales sont livrés dans une autre tonalité que le fond.
- Italcer S.p.A. SB n'est responsable que des opérations de doucissage et de polissage effectuées dans ses usines.
- La garantie ne couvre que le remplacement du matériau non posé réputé défectueux, à l'exclusion de toute autre indemnité.

2. COMMANDES

- Les commandes envoyées à Italcer S.p.A. SB par l'Acheteur, par les commerciaux ou les représentants, ne sont réputées définitives qu'après acceptation par la direction de Italcer S.p.A. SB
- Sauf accords écrits contraires, toutes les commandes, y compris verbales, sont toujours considérées comme acceptées par Italcer S.p.A. SB aux présentes conditions générales, sans nul besoin de les rappeler. À défaut d'exceptions précises par écrit, l'Acheteur accepte l'intégralité des conditions générales et particulières de vente.

3. PRIX

- Les prix sont exprimés départ usine, hors TVA.
- Les europalettes non rendues lors du chargement seront facturées à 10,00 €/pièce.

4. LIVRAISON

- Les délais de livraison fixés avec Italcer S.p.A. SB ne sont donnés qu'à titre purement indicatif. En cas de force majeure, Italcer S.p.A. SB peut résilier le contrat de vente en tout ou partie.
- Les retards de livraison ne donnent jamais droit à l'Acheteur de résilier le contrat, ni de prétendre à des indemnités pour les dommages directs et indirects.
- La marchandise voyage toujours aux risques et périls de l'Acheteur. La marchandise est réputée achetée départ usine, même si le prix est formulé port payé jusqu'au lieu de destination convenu. La responsabilité de Italcer S.p.A. SB cesse à la fin du chargement. Dès lors, Italcer S.p.A. SB ne saurait être tenue pour responsable des dégâts, des altérations et des pertes.
- Lorsque la marchandise prête pour l'expédition reste dans les établissements de Italcer S.p.A. SB à la demande de l'Acheteur, la facture est émise comme si l'expédition avait eu lieu. Les matériaux sont alors stockés aux risques, périls et frais de l'Acheteur.

5. PAIEMENT

- Les paiements doivent être faits directement à l'adresse de Italcer S.p.A. SB, à Rubiera (RE). La marchandise reste la propriété de Italcer S.p.A. SB jusqu'au paiement intégral du prix établi.
- En cas de retard dans le paiement de tout ou partie d'une facture, Italcer S.p.A. SB aura la faculté d'interrompre, sans préjudice de tous ses autres droits, les autres livraisons, même des livraisons relatives à d'autres contrats, de tirer des traites pour le montant des factures échues, d'exiger le paiement immédiat et intégral de toute la marchandise commandée ou une autre forme de garantie.
- Tout retard de paiement entraînera pour l'Acheteur des intérêts et des charges bancaires aux taux en vigueur. Pour tout autre point non expressément prévu par les clauses susvisées, les parties s'accordent à appliquer la loi italienne et les normes en vigueur.

6. RÉCLAMATIONS

- Nous n'admettons aucune réclamation sur les produits déjà posés. Les vices et défauts du matériau doivent être dénoncés et communiqués dans les délais de loi. Dans la mesure où la réclamation est acceptée, l'Acheteur devra rendre le matériau objct de contestation pour permettre au Italcer S.p.A. SB de le remplacer par un lot du même type. Ce remplacement annule le droit de l'Acheteur de demander la résiliation du contrat, une remise sur le prix ou un dédommagement.
- Toute réclamation ou contestation n'implique ni l'interruption ni le refus de paiement des factures. Le paiement devra être régulier, intégral et conforme aux conditions établies.
- Aucun retour de marchandises ne sera accepté sans l'accord écrit de Italcer S.p.A. SB

7. TRIBUNAL COMPÉTENT

Tout litige sera du ressort du Tribunal de Reggio Emilia (Italie). Cependant Italcer S.p.A. SB se réserve le droit d'agir auprès du Tribunal de compétence du siège social de l'Acheteur pour le recouvrement de la créance. Dans ce cas, la loi locale s'applique.

Italcer S.p.A. SB behält sich das Recht vor, jederzeit die in diesem Katalog („Katalog“) enthaltenen Informationen und technischen Merkmale zu ändern die als nicht gesetzlich verbindlich zu betrachten sind. Gewicht, Farben und Abmessungen können infolge des besonderen Produktionsprozesses von Keramikprodukten typische Veränderungen aufweisen. Die Farben und ästhetischen Eigenschaften der Produkte entsprechen innerhalb der Grenzen der virtuellen Reproduktionsverfahren so weit wie möglich den effektiven Eigenschaften des Produkts. Italcer S.p.A. SB erachtet die in diesem Katalog genannten Informationen und technischen Spezifikationen als richtig und genau; Dies schließt jedoch das Vorhandensein von Materialfehlern nicht aus und fordert die Käufer ("Käufer") auf, die Informationen und technischen Spezifikationen bei den Referenzagenten / der Werbung zu überprüfen. © 2020 Italcer S.p.A. SB Alle Rechte vorbehalten. Der vollständige oder auszugsweise Nachdruck des Inhalts dieses Katalogs in Schrift und Bild ist verboten und wird nach Maßgabe des Gesetzes geahndet.

1. PRODUKTGEWÄHRLEISTUNG

- Die hohen beim Brennvorgang zum Einsatz kommenden Temperaturen können Unterschiede beim Farbton und Werkmaß verursachen. Abweichungen von den angegebenen Maßen sind daher vom Käufer zu akzeptieren, die von der Norm UNI-EN-ISO 14411 festgelegten Toleranzen dürfen dabei jedoch nicht überschritten werden.
- Italcer S.p.A. SB garantiert, dass die Produkte die derzeit geltenden UNI-EN und ISO-Normen erfüllen. Die Garantie wird ausschließlich auf Material erster Wahl beschränkt. Die Materialien zweiter und dritter Wahl und Sonderposten verstehen sich verkauft „wie gesehen“ und können nicht reklamiert werden.
- Die Farbtöne der als Muster präsentierten Materialien sind nur zur Orientierung gedacht. Eventuelle Abweichungen bei Farbe und Farbton gehen auf die Natur des Materials, die Merkmale des Produktionsverfahrens und die verwendeten Rohstoffe zurück. Daher wird empfohlen die Fliesen zu mischen, indem sie verschiedenen Schachteln entnommen werden, und das Material mit einer Abstandsfulge zu verlegen.
- Dekore und Sonderstücke werden in Farbtönen angeboten, die sich von den Grundfliesen unterscheiden.
- Italcer S.p.A. SB ist nur für das im eigenen Werk erfolgte Polieren und Glanzpolieren haftbar.
- Die Garantie umfasst nur den Ersatz des nicht verlegten, fehlerhaften Materials, sonstige Ansprüche sind ausgeschlossen.

2. BESTELLUNGEN

- Jede Bestellung, die von Italcer S.p.A. SB, von den Handelsvertretern oder den Bevollmächtigten an den Verkäufer übermittelt wird, versteht sich als akzeptiert, dabei wird stets vorausgesetzt, dass die Genehmigung durch Italcer S.p.A. SB selbst erfolgt.
- Alle Bestellungen, auch solche mündlicher Art, wenn nicht schriftlich eine abweichende Vereinbarung erfolgte, verstehen sich stets von Italcer S.p.A. SB als zu den allgemeinen Geschäftsbedingungen akzeptiert, ohne dass eine Erinnerung erfolgen muss. Wenn keine genauen schriftlichen Ausnahmen vereinbart wurden, versteht es sich, dass der Käufer umfassend die allgemeinen Geschäftsbedingungen akzeptiert.

3. PREISE

- Die Preise verstehen sich für Waren ab Herstellungswerk, zuzügl. Mehrwertsteuer.
- EURO-Paletten werden zum Preis von 10,00 EUR/Stück berechnet, falls bei der Beladung kein Austausch erfolgt.

4. LIEFERUNG

- Die mit Italcer S.p.A. SB vereinbarten Lieferbedingungen dienen nur zur Orientierung. Bei Fällen Höherer Gewalt, kann Italcer S.p.A. SB ganz oder zum Teil vom Kaufvertrag zurücktreten.
- Lieferverspätungen geben dem Käufer in keinem Fall das Recht, vom Vertrag zurückzutreten oder einen Schadensersatz für eventuelle mittelbare oder unmittelbare Schäden zu verlangen.
- Die Ware wird stets auf Risiko des Käufers transportiert. Die Ware versteht sich vom Käufer als ab Werk erworben, auch wenn der Preis sich frei Bestimmungsort versteht. Jede Haftung von Italcer S.p.A. SB endet nach der erfolgten Beladung, der Verkäufer haftet nicht für einen eventuellen Bruch, die Manipulation und das Fehlen von Material.
- Wenn die bereits lieferfertige Ware auf Wunsch des Käufers im Werk von Italcer S.p.A. SB verbleibt, wird die Rechnung ausgestellt, als ob die Fracht erfolgt wäre und die Materialien werden auf Gefahr, Risiko und Kosten des Käufers im Lager aufbewahrt.

5. ZAHLUNGSBEDINGUNGEN

- Die Zahlungen müssen direkt an Italcer S.p.A. SB an den Firmensitz in Rubiera (RE) erfolgen. Die Waren bleiben Eigentum von Italcer S.p.A. SB, bis die vollständige Zahlung des vereinbarten Preises erfolgt ist.
- Sollte die Gesamt- oder Teilzahlung einer Rechnung verspätet erfolgen, ist Italcer S.p.A. SB, vorbehaltlich anderer Ansprüche, berechtigt, weitere Lieferungen einzustellen, auch wenn diese sich auf andere Verträge beziehen, Wechsel auf den Betrag der fälligen Rechnungen auszustellen und auch die sofortige und gesamte Zahlung des gesamten bestellten Materials zu verlangen, oder eine anderweitige Garantie zu erhalten.
- Bei einer Zahlungsverzögerung werden dem Käufer Verzugszinsen und Bankgebühren zu den aktuellen Tarifen in Rechnung gestellt. Für alles, was in den obigen Klauseln nicht vorgesehen ist, wird auf das Italienische Recht und üblichen Gepflogenheiten verwiesen.

6.REKLAMATIONEN

- Es werden keine Reklamationen für bereits verlegte Fliesen akzeptiert. Reklamationen für Materialmängel und –fehler müssen im Rahmen der gesetzlichen Bestimmungen mitgeteilt werden. Wird eine Reklamation genehmigt, muss der Käufer das Material, das Gegenstand der Beanstandung ist, zurücksenden. Dieses wird von Italcer S.p.A. SB durch eine entsprechende gleichwertige Lieferung ersetzt. Der Ersatz des Materials macht das Recht des Käufers auf eine Auflösung des Vertrags oder eine Preisermäßigung, bzw. einen Schadensersatz unwirksam.
- Keine Reklamation oder Beanstandung rechtfertigt eine Zahlungseinstellung oder eine Verweigerung, die Rechnungen zu zahlen. Die Zahlung hat ordnungsgemäß und vollständig zu den vereinbarten Bedingungen zu erfolgen.
- Warenrückgaben werden nicht akzeptiert, wenn diese nicht vorher schriftlich von Italcer S.p.A. SB genehmigt wurden.

7. GERICHTSSTAND

Gerichtsstand für alle Streitigkeiten ist Reggio Emilia (Italien). Italcer S.p.A. SB behält sich das Recht vor, bei dem zuständigen Gericht am Sitz des Käufers Klage auf Rückforderung von Krediten zu erheben. In diesem Fall gilt das örtliche Recht.

Note generiche sui prodotti /

General information on the products / Notes generales sur les produits / Allgemeine angaben zu den produkten

Informazioni generali sui prodotti /

Italcer S.p.A. SB si riserva di apportare, senza alcun preavviso, le modifiche che riterrà più opportune al fine di migliorare il prodotto. Quanto riportato è da considerarsi indicativo e non esaustivo in riferimento ai colori e alle caratteristiche estetiche dei prodotti.

Italcer S.p.A. SB reserves the right to make any changes it deems fit in order to improve the product, without prior notice. All images are provided for illustrative purposes only and other colours and aesthetic features are available.

Italcer S.p.A. SB se réserve le droit d'apporter, sans préavis, les modifications qu'elle jugera opportunes afin d'améliorer le produit. Les informations ci-dessus sont fournies à titre indicatif et elles ne sont pas contraignantes en ce qui concerne les couleurs et les caractéristiques esthétiques des produits.

Die Firma Italcer S.p.A. SB behält sich vor, ohne jegliche vorherige Ankündigung jene Änderungen vorzunehmen, die sie zur Verbesserung des Produktes für angebracht hält. Die Angaben sind bezüglich der Farben und ästhetischen Eigenschaften der Produkte als Richtwerte und nicht als vollständig anzusehen.

Informazioni generali sui prodotti /

Le cromie, le strutture e le grafiche delle piastrelle riprodotte nelle immagini del catalogo potrebbero non corrispondere fedelmente al prodotto industriale.

The colours, structures, and patterns of the tiles illustrated in the catalogue might not correspond exactly to the actual product.

Les tonalités, les structures et les graphismes des carreaux reproduits sur les images du catalogue pourraient ne pas correspondre fidèlement au produit industriel.

Es ist möglich, dass die im Katalog abgebildeten Fliesen in Bezug auf Farbton, Struktur und Grafik vom Industrieerzeugnis abweichen.

Informazioni generali sui prodotti /

- ATTENZIONE: Per particolari installazioni potrebbero essere necessari articoli ed accessori specifici non presenti in questo catalogo. Per queste esigenze prego riferirsi direttamente al referente commerciale LA FABBRICA AVA.**

N.B. Particular items and accessories not listed in this catalogue may be required for certain laying methods. For these needs, please contact the LA FABBRICA AVA sale sales directly.

ATTENTION: Pour les installations particulières, certains articles et accessoires particuliers qui ne sont pas indiqués dans ce catalogue pourraient être nécessaires. Dans ces cas-là, nous vous prions de vous référer directement à la référence commerciale LA FABBRICA AVA.

ACHTUNG: Für besondere Installationen können besondere Artikel oder Sonderzubehör notwendig sein, die nicht im vorliegenden Katalog aufgeführt sind. Wenden Sie sich bitte in diesen Fällen direkt an den Vertrieb von LA FABBRICA AVA.

Informazioni generali sui prodotti /

- I pesi riportati in tabella sono indicativi in quanto possono subire leggere variazioni per motivi produttivi.**

The weights stated in the chart are approximate as some changes may be necessary for production reasons.

Les poids figurant dans le tableau sont fournis à titre indicatif car ils peuvent subir de légères variations pour des raisons de production.

Die in der Tabelle aufgeführten Gewichte sind nicht bindend, da sie aus Produktionsgründen leichte Änderungen aufweisen können.

Informazioni generali sui prodotti /

- La struttura e il tono tra i fondi di spessore 6mm e 8,8mm potrebbero presentare differenze.**

The structure and shade of the tiles with 6 mm and 8.8 mm thickness could show differences.

La structure et le ton entre les bases de 6 mm et de 8,8 mm d'épaisseur pourraient présenter des différences.

Struktur und Farbton der Grundfliesen in 6 und 8,8 mm Stärke können Abweichungen aufweisen.

Informazioni generali sui prodotti /

- Tra i fondi di spessore 8,8, e 20 mm non si garantisce l'abbinabilità.**

We cannot guarantee tonal matches between the same background tiles with different thickness (8,8,10 or 20 mm).

Les assortiments des tons ne sont pas garantis pour les fonds d'une épaisseur de 8,8, 10 et 20 mm.

Bei Bodenfliesen mit einer Stärke von 8,8, 10 und 20 mm wird keine Einheitlichkeit der Farbtöne garantiert.

Informazioni generali sui prodotti /

- Per il gradino non si garantisce la stessa tonalità del fondo.**

We cannot guarantee that the shade of the stair tile will be the same as the background tile.

Pour la marche, nous ne garantissons pas la même tonalité du fond.

Für die Stufe wird nicht der gleiche Farbton der Grundfliese garantiert.

Informazioni generali sui prodotti /

- La tonalità del colore della piastrella nelle finiture liscia e strutturata potrebbe essere leggermente dissimile.**

The colour shading of smooth and structured finishing may vary slightly.

La tonalité de la couler du carreau dans les finitions lisses et structurées peut être légèrement différente.

Bei der Farbtönung von Fliesen mit glatter oder mit strukturierter Oberfläche kann es zu leichten Abweichungen kommen.

Informazioni generali sui prodotti /

- In caso di posa modulare il grado di stonalizzazione del pavimento potrebbe aumentare rispetto ad una posa monoformato.**

On pattern sizes floors the shading may result being more intense than on a single format floor.

En cas de pose modulaire, le degré de tonalisation du carrelage pourrait augmenter par rapport à une pose monoformat.

Bei der Modulverlegung könnte sich der Grad der Tonalisierung im Vergleich zur Verlegung nur eines Fliesenformates erhöhen.

Informazioni generali sui prodotti /

- Tutti i decori si abbinano al fondo ma possono essere di tonalità diverse.**

All decorations match the base but may be of a different tone.

Tous les décors sont assortis au fond, mais les tonalités peuvent être différentes.

Alle Dekore passen zum Untergrund, können jedoch unterschiedliche Farbtöne aufweisen.

Informazioni generali sui prodotti /

- Si consiglia fortemente di pulire bene la superficie delle piastrelle strutturate immediatamente dopo aver fugato il pavimento. questa operazione eviterà al materiale usato per la fuga di solidificarsi all'interno delle cavità presenti nella superficie della piastrella.**

We strongly recommended you thoroughly clean the surface of textured floor tiles immediately after filling the

joints. This will prevent the filler solidifying in the cavities found in the tiles' surface.

Il est vivement recommandé de bien nettoyer la surface des carreaux structurés, immédiatement après le jointoyage. Cette opération empêchera le matériel utilisé pour le jointoyage de se solidifier à l'intérieur des cavités présentes à la surface des carreaux.

Es wird dringend geraten, die Oberfläche der strukturierten Fliesen sofort nach dem Verfugen des Bodenbelags gut zu reinigen. Dieser Vorgang verhindert, dass das zum Verfugen verwendete Material innerhalb der in der Fliesenoberfläche vorhandenen Hohlräume aushärten kann.

Informazioni generali sui prodotti /

- Decori con vetro e graniglie. Le decorazioni mediante l'applicazione dei vetri e delle graniglie vetrose sulle piastrelle ceramiche possono presentare delle irregolarità nella distribuzione di dette graniglie, questo non pregiudica l'effetto estetico del prodotto, ma anzi ne esalta le caratteristiche.**

Decors with glass and glass-grit. The decors produced by the application of glass and glass grit on ceramic tiles may have an irregular distribution when utilising the glass grit. This technique does not compromise the aesthetic effect of the decor and moreover it does enhance its technical features.

Décors avec pâtes de verre. Les décors fabriqués en appliquant des pâtes de verre sur les carreaux céramiques peuvent résender une distribution irrégulière de ces pâtes; ceci n'empêche pas l'effet esthétique du décor, mais au contraire améliore ses caractéristiques.

Dekore mit Buntglas und Spliteinsteerungen. Diese serie ist dekoriert mit buntglas und spliteinsteerungen. Bei der Anwendung dieser körnigen Glas Split Anteile, können optische, so wie strukturelle Unregelmäßigkeiten bei der Verteilung in der Oberfläche auftreten. Dies gilt als gewünschter Effekt, zur zusätzlichen ästhetische Aufwertung des Produkts.

Informazioni generali sui prodotti /

- Per un risultato ottimale si consiglia di utilizzare durante la posa i cunei.**

For a perfect result, we recommend you use wedges during laying.

Nous conseillons d'utiliser les coins durant la pose pour un résultat optimal.

Für ein ausgezeichnetes Ergebnis wird empfohlen, bei der Verlegung die Keile zu verwenden.

Informazioni generali sui prodotti /

- Si consiglia di mantenere una fuga di 2 mm per la posa in monoformato degli articoli rettificati.**

Si consiglia di mantenere una fuga di 3 mm per la posa in multiformato (da 2 formati e oltre) degli articoli rettificati. Si consiglia di mantenere una fuga di 4 mm per la posa degli articoli con bordi non rettificati.

If you are laying same sized straightened-edged tiles, we recommend you keep a 2 mm joint. If you are laying different sized straightened-edged tiles (two or more sizes) together, we recommend you keep a 3 mm joint.

In the case of non-straightened-edged tiles, we recommend you keep a 4 mm joint.

On conseille de préserver un joint de 2 mm pour la pose en mon format des articles rectifiés.

On conseille de préserver un joint de 3 mm pour la pose en multiformat (de 2 formats et plus) des articles rectifiés. On conseille de préserver un joint de 4 mm pour la pose des articles présentant des bords non rectifiés.

Es wird geraten, eine Fuge von 2 mm bei der Verlegung der geschliffenen Artikel im Einzelformat einzuhalten. Es wird geraten, eine Fuge von 3 mm bei der Verlegung der geschliffenen Artikel als Multiformat (2 Formate und mehr) einzuhalten.

Es wird geraten, eine Fuge von 4 mm bei der Verlegung der Artikel mit ungeschliffenen Rändern einzuhalten.

Informazioni generali sui prodotti /

- Per un risultato ottimale si consiglia di utilizzare durante la posa i cunei.**

For a perfect result, we recommend you use wedges during laying.

Nous conseillons d'utiliser les coins durant la pose pour un résultat optimal.

Für ein ausgezeichnetes Ergebnis wird empfohlen, bei der Verlegung die Keile zu verwenden.

Informazioni generali sui prodotti /

- Per un risultato ottimale si consiglia di utilizzare durante la posa i cunei.**

For a perfect result, we recommend you use wedges during laying.

Nous conseillons d'utiliser les coins durant la pose pour un résultat optimal.

Für ein ausgezeichnetes Ergebnis wird empfohlen, bei der Verlegung die Keile zu verwenden.

Informazioni generali sui prodotti /

- Si consiglia di mantenere una fuga di 2 mm per la posa in monoformato degli articoli rettificati.**

Si consiglia di mantenere una fuga di 3 mm per la posa in multiformato (da 2 formati e oltre) degli articoli rettificati. Si consiglia di mantenere una fuga di 4 mm per la posa degli articoli con bordi non rettificati.

If you are laying same sized straightened-edged tiles, we recommend you keep a 2 mm joint. If you are laying different sized straightened-edged tiles (two or more sizes) together, we recommend you keep a 3 mm joint.

In the case of non-straightened-edged tiles, we recommend you keep a 4 mm joint.

On conseille de préserver un joint de 2 mm pour la pose en mon format des articles rectifiés.

On conseille de préserver un joint de 3 mm pour la pose en multiformat (de 2 formats et plus) des articles rectifiés. On conseille de préserver un joint de 4 mm pour la pose des articles présentant des bords non rectifiés.

Es wird geraten, eine Fuge von 2 mm bei der Verlegung der geschliffenen Artikel im Einzelformat einzuhalten. Es wird geraten, eine Fuge von 3 mm bei der Verlegung der geschliffenen Artikel als Multiformat (2 Formate und mehr) einzuhalten.

Es wird geraten, eine Fuge von 4 mm bei der Verlegung der Artikel mit ungeschliffenen Rändern einzuhalten.

Informazioni generali sui prodotti /

Informazioni generali sui prodotti /

- Tutti i decori si abbinano al fondo ma possono essere di tonalità diverse.**

All decorations match the base but may be of a different tone.

Tous les décors sont assortis au fond, mais les tonalités peuvent être différentes.

Alle Dekore passen zum Untergrund, können jedoch unterschiedliche Farbtöne aufweisen.

Informazioni generali sui prodotti /

- Si consiglia fortemente di pulire bene la superficie delle piastrelle strutturate immediatamente dopo aver fugato il pavimento. questa operazione eviterà al materiale usato per la fuga di solidificarsi all'interno delle cavità presenti nella superficie della piastrella.**

We strongly recommended you thoroughly clean the surface of textured floor tiles immediately after filling the

joints. This will prevent the filler solidifying in the cavities found in the tiles' surface.

Il est vivement recommandé de bien nettoyer la surface des carreaux structurés, immédiatement après le jointoyage. Cette opération empêchera le matériel utilisé pour le jointoyage de se solidifier à l'intérieur des cavités présentes à la surface des carreaux.

Es wird dringend geraten, die Oberfläche der strukturierten Fliesen sofort nach dem Verfugen des Bodenbelags gut zu reinigen. Dieser Vorgang verhindert, dass das zum Verfugen verwendete Material innerhalb der in der Fliesenoberfläche vorhandenen Hohlräume aushärten kann.

Informazioni generali sui prodotti /

- Decori con vetro e graniglie. Le decorazioni mediante l'applicazione dei vetri e delle graniglie vetrose sulle piastrelle ceramiche possono presentare delle irregolarità nella distribuzione di dette graniglie, questo non pregiudica l'effetto estetico del prodotto, ma anzi ne esalta le caratteristiche.**

Decors with glass and glass-grit. The decors produced by the application of glass and glass grit on ceramic tiles may have an irregular distribution when utilising the glass grit. This technique does not compromise the aesthetic effect of the decor and moreover it does enhance its technical features.

Décors avec pâtes de verre. Les décors fabriqués en appliquant des pâtes de verre sur les carreaux céramiques peuvent résender une distribution irrégulière de ces pâtes; ceci n'empêche pas l'effet esthétique du décor, mais au contraire améliore ses caractéristiques.

Dekore mit Buntglas und Spliteinsteerungen. Diese serie ist dekoriert mit buntglas und spliteinsteerungen. Bei der Anwendung dieser körnigen Glas Split Anteile, können optische, so wie strukturelle Unregelmäßigkeiten bei der Verteilung in der Oberfläche auftreten. Dies gilt als gewünschter Effekt, zur zusätzlichen ästhetische Aufwertung des Produkts.

Informazioni generali sui prodotti /

- Per un risultato ottimale si consiglia di utilizzare durante la posa i cunei.**

For a perfect result, we recommend you use wedges during laying.

Nous conseillons d'utiliser les coins durant la pose pour un résultat optimal.

Für ein ausgezeichnetes Ergebnis wird empfohlen, bei der Verlegung die Keile zu verwenden.

Informazioni generali sui prodotti /

- Per un risultato ottimale si consiglia di utilizzare durante la posa i cunei.**

For a perfect result, we recommend you use wedges during laying.

Nous conseillons d'utiliser les coins durant la pose pour un résultat optimal.

Für ein ausgezeichnetes Ergebnis wird empfohlen, bei der Verlegung die Keile zu verwenden.

Informazioni generali sui prodotti /

- Per un risultato ottimale si consiglia di utilizzare durante la posa i cunei.**

For a perfect result, we recommend you use wedges during laying.

Nous conseillons d'utiliser les coins durant la pose pour un résultat optimal.

Für ein ausgezeichnetes Ergebnis wird empfohlen, bei der Verlegung die Keile zu verwenden.

Informazioni generali sui prodotti /

- Per un risultato ottimale si consiglia di utilizzare durante la posa i cunei.**

For a perfect result, we recommend you use wedges during laying.

Nous conseillons d'utiliser les coins durant la pose pour un résultat optimal.

Für ein ausgezeichnetes Ergebnis wird empfohlen, bei der Verlegung die Keile zu verwenden.

Informazioni generali sui prodotti /

- Per un risultato ottimale si consiglia di utilizzare durante la posa i cunei.**

For a perfect result, we recommend you use wedges during laying.

Nous conseillons d'utiliser les coins durant la pose pour un résultat optimal.

Für ein ausgezeichnetes Ergebnis wird empfohlen, bei der Verlegung die Keile zu verwenden.

Informazioni generali sui prodotti /

- Per un risultato ottimale si consiglia di utilizzare durante la posa i cunei.**

For a perfect result, we recommend you use wedges during laying.

Nous conseillons d'utiliser les coins durant la pose pour un résultat optimal.

Für ein ausgezeichnetes Ergebnis wird empfohlen, bei der Verlegung die Keile zu verwenden.

Informazioni generali sui prodotti /

- Per un risultato ottimale si consiglia di utilizzare durante la posa i cunei.**

For a perfect result, we recommend you use wedges during laying.

Nous conseillons d'utiliser les coins durant la pose pour un résultat optimal.

Für ein ausgezeichnetes Ergebnis wird empfohlen, bei der Verlegung die Keile zu verwenden.

Informazioni generali sui prodotti /

Italcer S.p.A. SB si riserva di apportare, senza alcun preavviso, le modifiche che riterrà più opportune al fine di migliorare il prodotto. Quanto riportato è da considerarsi indicativo e non esaustivo in riferimento ai colori e alle caratteristiche estetiche dei prodotti.

Italcer S.p.A. SB reserves the right to make any changes it deems fit in order to improve the product, without prior notice.

All images are provided for illustrative purposes only and other colours and aesthetic features are available.

Informazioni generali sui prodotti /

Le cromie, le strutture e le grafiche delle piastrelle riprodotte nelle immagini del catalogo potrebbero non corrispondere fedelmente al prodotto industriale.

The colours, structures, and patterns of the tiles illustrated in the catalogue might not correspond exactly to the actual product.

Les tonalités, les structures et les graphismes des carreaux reproduits sur les images du catalogue pourraient ne pas correspondre fidèlement au produit industriel.

Es ist möglich, dass die im Katalog abgebildeten Fliesen in Bezug auf Farbton, Struktur und Grafik vom Industrieerzeugnis abweichen.

Consulta il sito **www.lafabbrica.it** per vedere gli ultimi aggiornamenti.

Check out our website at **www.lafabbrica.it** for the latest updates.

Consultez le site **www.lafabbrica.it** pour connaître les dernières mises à jour.

Auf der Website **www.lafabbrica.it** finden Sie die neuesten Informationen.

Informazioni generali sui prodotti /

Informazioni generali sui prodotti /

AD: MARKETING LA FABBRICA AVA
PRINT: OFFICINE GRAFICHE STAGED S.R.L.

EDIZIONE I - GENNAIO 2024



FOLLOW US

ITALCER S.p.A. SB | P.IVA 00142060359

Amministrazione e Sede Legale
Accounting and Legal Head Office

Via Emilia Ovest 53/A - 42048 Rubiera (RE) - Italy
Tel. +39 0522 625111
Fax +39 0522 625160

Uffici Commerciali e Showroom
Sales Department and Showroom

Via Emilia Ponente 2070 - 48014 Castel Bolognese (RA) Italy
Tel. +39 0546 - 659911 - Fax +39 0546 - 656223
info@lafabbrica.it - www.lafabbrica.it

